

 **Beta**

2022

EN

General Programme



www.beta-tools.com

THE HISTORY OF ITALIAN TOOLS

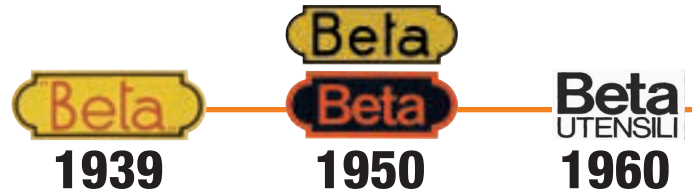

- 1923 - Alessandro Ciceri founded "Alessandro Ciceri & Figli", to manufacture iron and steel casts.
- 1939 - The trademark Beta was registered and the Company became involved mainly in manufacturing professional tools.
- 1960 - Beta Utensili employed two hundred people, exported their products and stood out as an up-and-coming manufacturer of professional tools.
- 1969 - The revolutionary orange sheet metal "Tank" trolley was developed; from that moment orange would result in a unique style for the trademark Beta.
- 1971 - Beta Utensili entered the motor racing world, with a view to testing and developing their products.
- 1975 - The Company scored their first Formula 1 victory with the orange March-Beta Utensili driven by Vittorio Brambilla, who won the Austrian Grand Prix in Zeltweg, in the pouring rain.
- 1980 - Beta Utensili further penetrated the main European markets, progressively establishing branches in France, Britain, Holland, Spain, Poland and Hungary.
- 1995 - It took the Company no more than 8 months to have their Quality System certified in accordance with the ISO 9001 standards.
- 2000 - The launch of the new Beta Utensili catalogue testified to ongoing growth. The range of available products was doubled, and the over 10,000 coded items were divided into 20 product families.
- 2002 - Beta Utensili's range was further expanded, being supplemented with safety footwear as well as with work and free-time wear, namely the "Beta Work" range.
- 2009 - Beta further expanded their markets, establishing Beta China.
- 2012 - Beta Brazil was founded.
- 2016 - Beta introduces a new modular workshop equipment combination system.
- 2018 - **BM** In 2018 BM S.p.A - leader in the production and sales of crimping terminals and electric connection systems - becomes part of the Beta Group.
- 2019 - Beta Utensili took over **Abra Beta S.p.A**, a market leader in the production of resin bond reinforced abrasives for grinding and cutting all types of materials and shaft-mounted wheels.
- 2020 - Ongoing growth has translated into the current product range – distributed worldwide –, which exceeds **14,000 coded items**, designed to satisfy the most demanding professionals' requirements.



1939 Forging department



1950 Galvanising department



1955 Shearing department



1960 Shipping warehouse



1969 Tank trolley



1975 Chrome finishing



1974 Vittorio Brambilla



1980 Engineering department



1981 New assortments



2002 "BetaWork"



2016 Workshop equipment RSC55



2019 Andrea Dovizioso
NEW ITALIAN PARTNERSHIP

BETA UTENSILI S.p.A. - 20845 Sovico (MB)
Via A.Volta, 18 - Tel. 039.2077.1 - Fax 039.2010742
www.beta-tools.com

Robur Wire rope accessories: 67039 Sulmona (AQ)
Zona industriale - C.da S. Nicola - Tel. 0864.2504.1 - Fax 0864.253132
www.roburitaly.com - info@roburitaly.com



1970



1980

Beta GROUP



9 SUBSIDIARIES

8 Beta - 1 BM

*Active in more than
100 countries
worldwide with over
250 importers*



7 PRODUCTION
UNITS



MORE THAN
800 STAFF





RESEARCH AND DEVELOPMENT

Ergonomics, finish and design serving reliability

For Beta, design does not just mean appearance but above all excellent performance. The study and design of a tool are aimed at achieving safety, strength and easy use. This is why tool design is based on functional needs: functionality leads to appearance, and design becomes the end result of a detailed study of materials and finishes. With this aim in mind, Beta constantly renews the design of its products, reviewing their parts and materials.

1150HPC Hypercut

*Cutting edge made from M2
sintered steel.
Cutting edge hardness:
65HRC*



42SLIM

*Ideal for tightening
in small spaces*

665

Digibeta

*The new way
of tightening*

MADE IN BETA

Ongoing innovation, designed
and manufactured in Italy.

1150INOX

*Stainless,
sterilizable,
recyclable*

We asked our engineers to boost the design of ground-breaking tools. We asked them to rely on new technologies, select the best-performing materials, state-of-the-art surface finishing and heat treatment, and develop new geometries and working processes.

Remarkable results were obtained; a new generation of tools is now available and will keep growing over the next few years: this is only the beginning.

C37

*New
Design*





CERTIFIED QUALITY

In 2018 Beta roller cabs were awarded prestigious TÜV certification, after passing severe tests according to protocol EK5/TA5.

Protocol EK5/TA5 deals with 31 well-defined building characteristics, stringent static tests and dynamic behaviour tests. Other tests determine resistance to high and low temperatures, the service life of markings over time and corrosion resistance.

Credit for this achievement is due to the expert design, accurate manufacture and stringent tests Beta relies on for its roller cabs, which has allowed their quality to be acknowledged by end users.



CONTROL AND QUALITY

Beta quality, our most concrete proof

At Beta, quality has a simple, concrete meaning: "that which fully satisfies the needs and expectations of the professional users who rely on our products as an irreplaceable working instrument". Tools are not only designed and manufactured correctly to fulfil a need, but they must guarantee repeat performances consistently over time. At Beta, quality goes beyond a merely attentive industrial and sales policy, to permeate every company division, driving us all to achieve increasingly ambitious goals in terms of customer satisfaction. Beta has built its history on this very concept.

**The quality of Beta tools
is a synergy
of age-old techniques
and new technologies.**

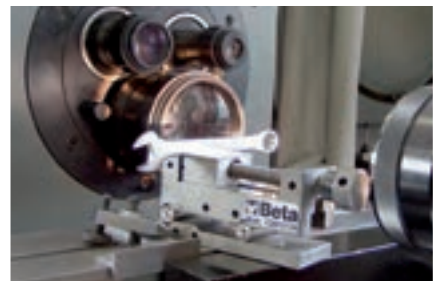

Since 1995 our production processes have complied with the ISO 9001 Quality System standards





WORK ORGANIZATION

SORT

Remove all unnecessary items from the workplace; only keep the items you need.

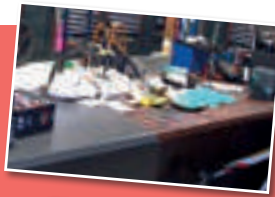

SET IN ORDER

Put everything into its proper place: a place for everything and everything in its place.



SHINE

Keep the workplace clean and tidy.



STANDARDIZE

Establish consistent work practices to keep rationalizing resources and spaces, determining a standard to implement.



SUSTAIN

Support and spread this mindset and behaviour across the organization.



SEIRI

SORT

SEITON

SET IN ORDER

SEISO

SHINE

SEIKETSU

STANDARDIZE

SHITSUKE

SUSTAIN



BEFORE

5S is a workplace organization method of Japanese origin. The name is derived from the western transcription of 5 Japanese words: **seiri, seiton, seiso, seiketsu and shitsuke.**

Following the 5 steps identified by the words allows a systematic, repeatable method to be implemented with a view to optimized working standards and enhanced operating performance.

5S

BENEFITS



Reduced time loss and improved cost-effectiveness

A proper organization and transport system for your tools will allow you to have everything you need, where you need it, and within reach.



Enhanced quality and productivity

Standard equipment does not always cater to our needs. Creating your equipment on an item-by-item basis will allow you to fully adapt it to your requirements, which will result in improved reliability and performance.



Fewer work accidents

Most accidents occur while using tools. Arranging all necessary items so that they can be easily selected for use and removing all unnecessary items will allow you to minimize misuse and reduce hazards.



Greater efficiency

Reducing the number of defects and errors will allow you to avoid delays, optimize processes and improve the company's results and efficiency.





EXPERT ADVICE

Manufacturing requirements are changing on a daily basis and are becoming increasingly complex. The emphasis is on optimizing time, improving performance and cutting costs. Hence every day our Technical and Sales Consultants make all their expertise and skills available, to recommend the solutions that best cater to users' needs. Beta's Consultants always work hand in hand with the dense network of dealers and distributors, who play a key role in achieving this productive synergy.

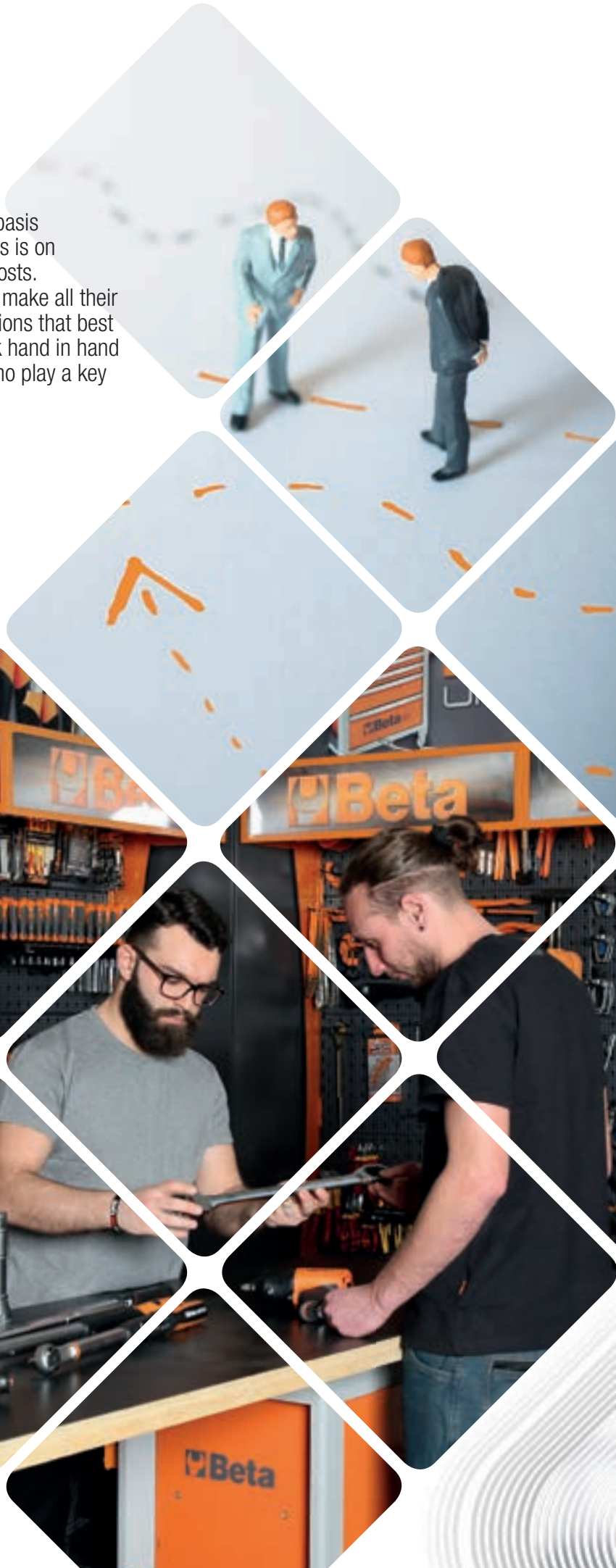

EFFECTIVE PRESENCE



*Demonstration unit
2019*





RANGE AND ITEMS

Over 14,000 items

The dynamism of the Company has, over the years, helped it to effectively update its product range to promptly respond to the challenges of the global market.

Today the Beta Utensili range comprises over 14,000 items divided into 30 product families, making it one of the most qualified names in the tool market.

Beta produces tools for professional mechanics, from industrial maintenance to car repairs, and for all those whose hobbies are much more than a simple pastime.

30

families

*Each professional
need finds
an effective solution*

Applications

**Automotive
Energy
Industry
Oil & Gas
Aeronautics**



SALES SUPPORT

www.beta-tools.com

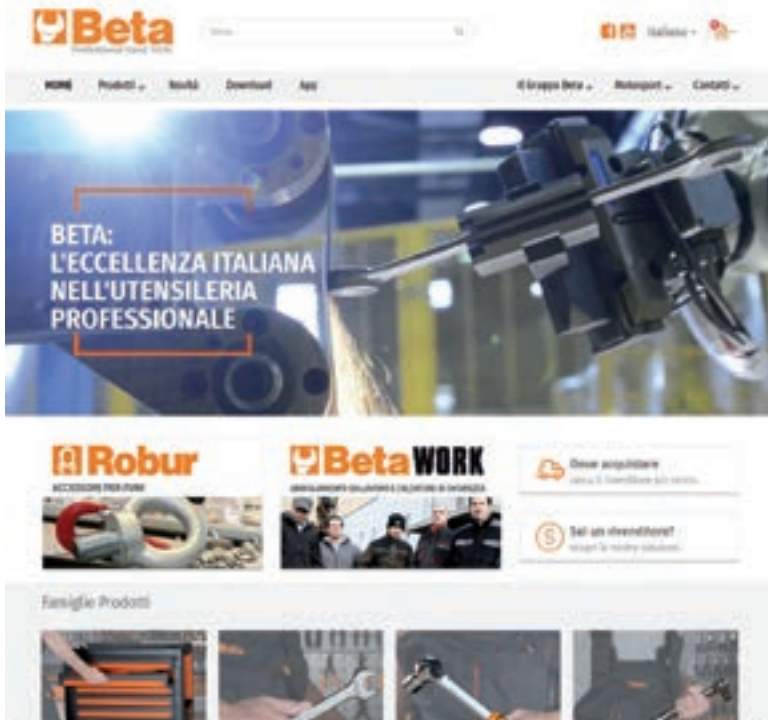

An “easy” and complete website where you can find our updated catalogues, latest news, promotions and all our technical product information (manuals, spare parts and demo videos, which can also be found on YouTube)

Beta supplies different store display solutions to offer customers a “turnkey” service.



A specific app of all the Beta catalogues for IOS and Android.



Autopromotec
2019



WORLDWIDE DISTRIBUTION

Active in over **100 countries** worldwide



Beta's far-reaching distribution network serves professional users across the world.



8 Subsidiaries

Beta China



Beta France



Beta Iberia



Beta Polska



Beta Brasil



Beta Benelux



Beta UK



Beta Hungary



LOGISTICS

16,000 m²
surface area

**Quick,
prompt
and complete
deliveries**



14.000
coded items
and over **27.000**
loading units





INDEX



WORKSHOP EQUIPMENT RSC55



☐ 348÷371

RSC55

WORKSHOP EQUIPMENT C45



☐ 372÷381

CONTAINERS AND ASSORTMENTS



☐ 294÷347



☐ 382÷465

WRENCHES



☐ 24÷30



☐ 36÷38



☐ 103÷107

SOCKETS AND ACCESSORIES



☐ 68÷74



☐ 82÷103

TORQUE WRENCHES AND MULTIPLIERS



☐ 59÷61



☐ 61÷68

SCREWDRIVERS, MALE-END WRENCHES AND BITS



PLIERS AND NIPPERS

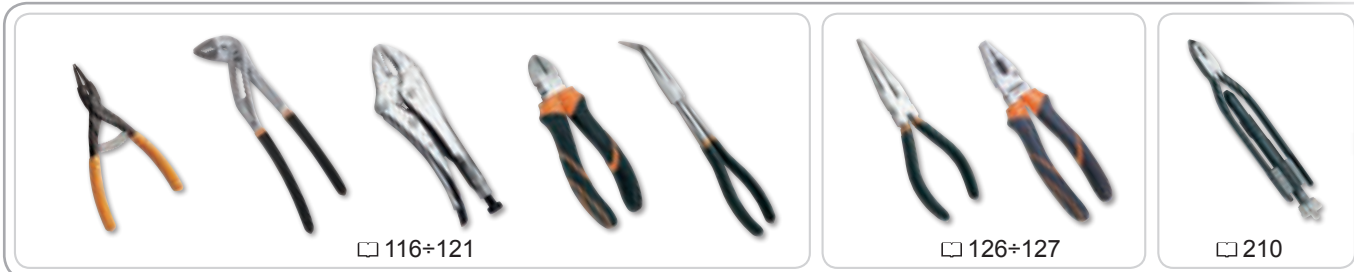

HAMMERS AND CHISELS



DRILLING AND THREADING TOOLS



PULLERS



MEASURING AND MARKING TOOLS

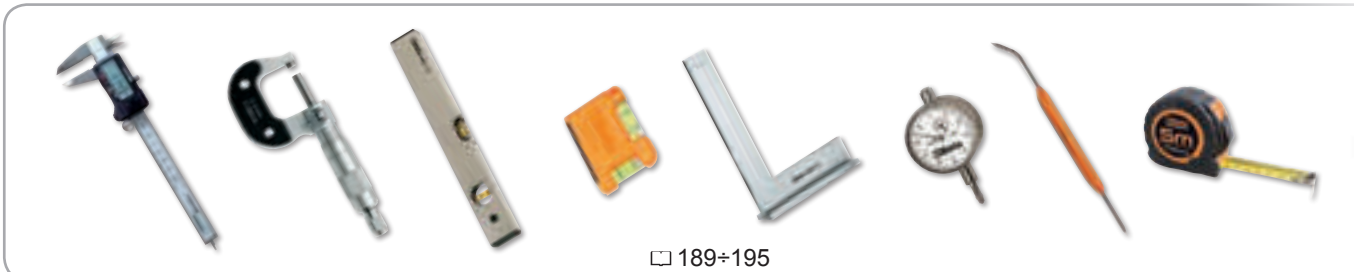

CUTTING AND GENERAL MAINTENANCE TOOLS

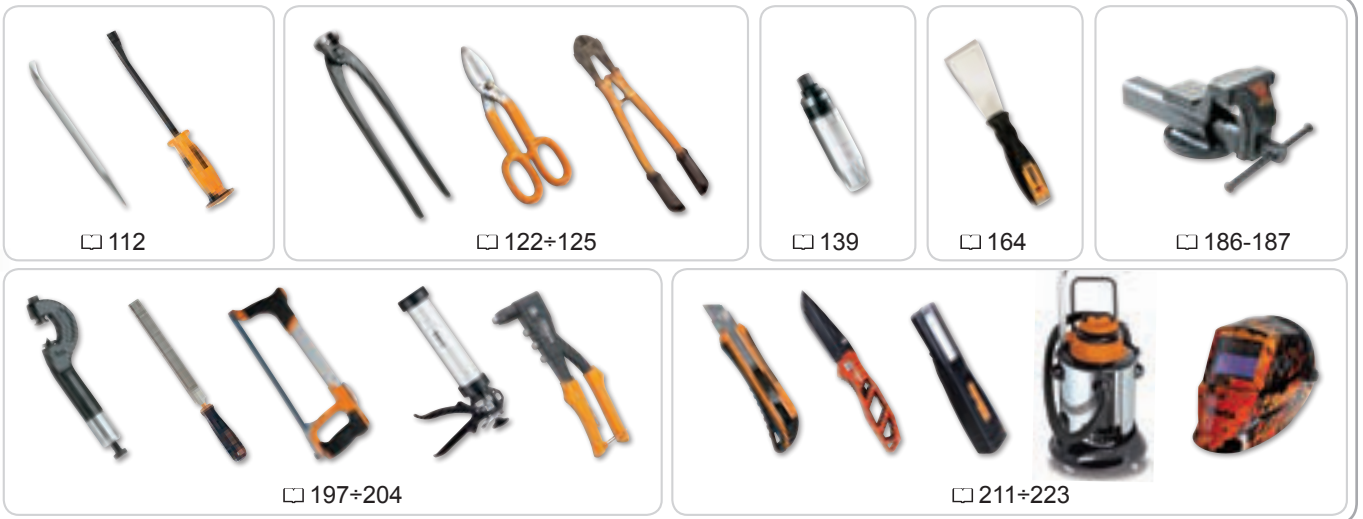

PLUMBING TOOLS



ELECTRONICS AND MICROMECHANICS



ELECTROTECHNICS



1000V INSULATED TOOLS

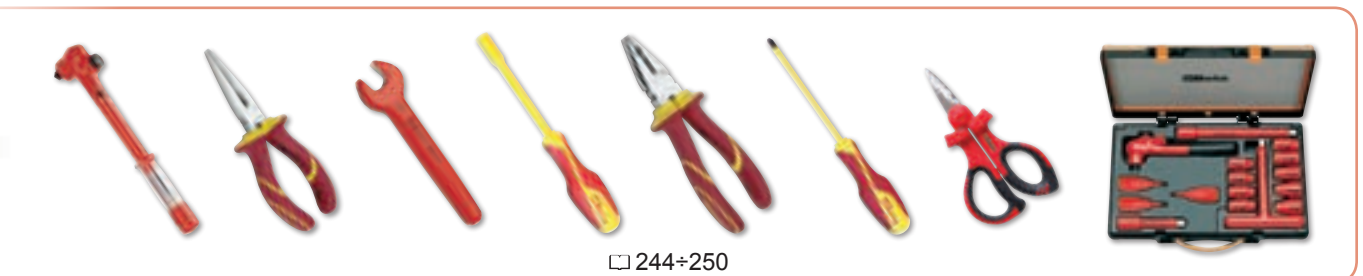

STAINLESS STEEL



☐ 258÷262

SPARKPROOF TOOLS



☐ 263÷271

VEHICLE REPAIR



☐ 105÷115



☐ 150÷178



☐ 140÷146



☐ 207÷210



☐ 223÷235

MOTORCYCLE TOOLS



☐ 236÷239

BICYCLE TOOLS



☐ 240÷243

BATTERY TOOLS

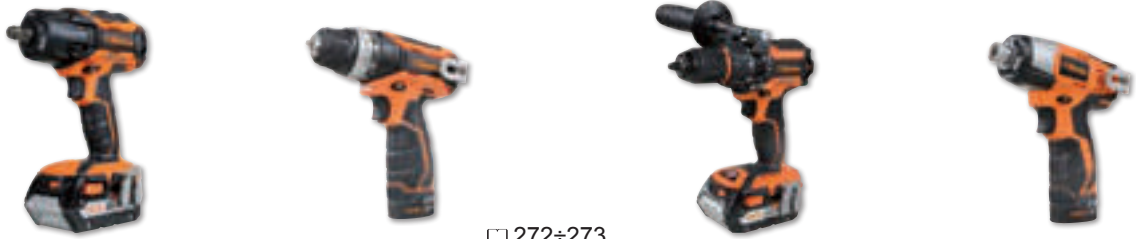

□ 272÷273

PNEUMATIC TOOLS AND ACCESSORIES



□ 274÷293

TETHERED TOOLS

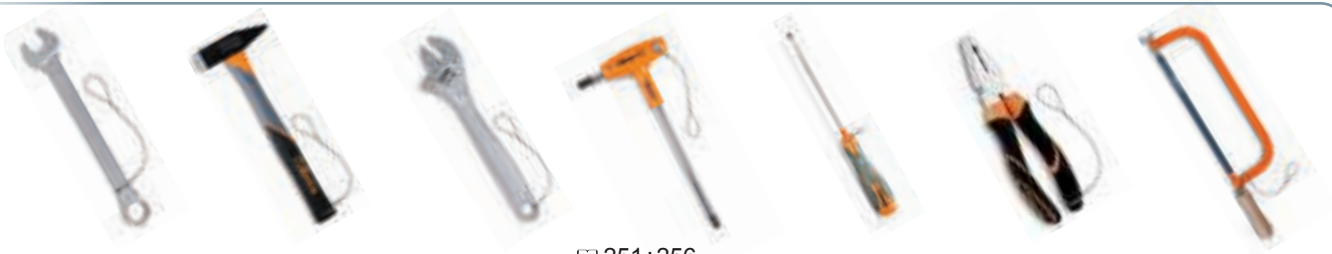

□ 251÷256

CHEMICAL PRODUCTS

 **Beta**
CHEMICALS



□ 466÷469

ABRASIVE TOOLS

 **Beta**
ABRASIVES



□ 470÷479

PRODUCTS UNDER THE BRAND NAME BM

 **BM**
GROUP



□ 480÷485

ROBUR WIRE ROPE ACCESSORIES



 **Robur**

☐ 550+584

SAFETY FOOTWEAR (AND TECHNICAL SOCKS)



 **Beta
WORK**

☐ 512+535

WORKWEAR



 **Beta
WORK**

☐ 536+549

DISPLAY UNITS FOR SALES POINTS



 **Beta
SHOP
in shop**

☐ 498+511

BLISTER PACK RANGE



☐ 486+497

BETA COLLECTION



 **Beta
Collection**

☐ 585+594



KEY READING

item number

42INOX

combination wrenches
made of stainless steel

in blister pack



tool profile



motorcycle tools



bicycle tools



★ item available on request

• main size

○ hexagon drive



size

code number

n.° of tools per box

new item 2020

n.° of tools per set

type of packaging

set content

mm	L mm	
6x6	95	2 000420306
7x7	105	2 000420307
8x8	116	2 000420308
9x9	127	2 000420309
10x10	137	2 000420310
11x11	148	2 000420311
12x12	158	2 000420312
13x13	169	2 000420313
14x14	180	2 000420314
15x15	190	2 000420315
16x16	201	2 000420316
17x17	212	2 000420317
18x18	222	2 000420318
19x19	233	2 000420319
21x21	254	1 000420321
22x22	264	1 000420322
24x24	285	1 000420324
27x27	290	1 000420327



42INOX/S11
6-8-10-11-12-13-
14-15-16-17-19 mm
1 000420391

Most used symbols

Example

Sets		Example
B	= in plastic wallet	42/B9
BV	= empty wallet	42/BV9
C	= in case	900/C11
D	= in hanging pack	1293/D6
S	= in box	42/S17
SP	= with display	42/SP25
SPV	= empty display	42/SPV7
SC	= with compact support	96/SC9
SCV	= compact support, empty	96/SCV

Assortments

AS	= with tools in inches	5915VU/AS
E	= Electronics/Electrotechnics	5980ET/A
I	= Plumbing	5980ID
MT	= Earth-moving	5902MT
U	= Universal	5915VU/3
SBK	= Motorcycle Repairs	5940SBK
VG	= Automotive	5904VG/5T
VI	= Industry	5902VI

Sockets

A	= hexagon profile	910A
B	= bi-hex profile	910B
ES	= grooved profile	920ES
FTX	= for TORX® screws	910FTX

Most used symbols

Example

PT	= for 5-star head screws	910PT
X	= reversible ratchet in cases	920A/C12X

Screwdrivers and bits

LP	= for slotted head screws	920LP
PE	= for hexagon screws	920PE
PH	= for cross head PHILLIPS® screws	920PH
PZ	= for cross head POZIDRIV® - SUPADRIV® screws	1299PZ
RTX	= for TAMPER RESISTANT TORX® screws	1298RTX
SP	= for SPANNER screws	861SP
TRW	= for TRI-WING® screws	861TRW
TQS	= for TORQ-SET® screws	861TQS
TX	= for TORX® head screws	920TX
XZN	= for XZN® screws	920XZN

Miscellaneous

AS	= sizes in inches	42AS
BA	= spark-proof tools	42BA
BM	= bi-material handle	1150BM
C	= empty metal container	C25
HS	= tethered tools	42HS
INOX	= tools made of stainless steel	42 INOX
L	= long series	952L
MQ	= 1000V insulated tools	1150MQ
MP	= bright finish	42MP
R	= spare part	338R

The pictures are given by way of example.
Beta Utensili reserve the right to update and enhance their product range without notice.



Beta RECOMMENDS using the tools correctly
and complying with personal protection standards.



30

drift punches



Ø mm	L mm	
2	125	10 000300020
3	125	10 000300030
4	150	10 000300040
5	150	10 000300050
6	150	10 000300060

31

pin punches



Ø mm	L mm	L1 mm	
2	110	22	10 000310002
3	128	35	10 000310003
4	146	45	10 000310004
5	164	55	10 000310005
6	182	65	5 000310006
8	200	80	5 000310008
10	220	95	5 000310010



31/B6	2-3-4-5-6-8 mm	1 000310020
42/BV6		1 000420051
31/SP6	2-3-4-5-6-8 mm	1 000310030
31/SPV		1 000310031

31BM

pin punches with handles



Ø mm	L mm	L1 mm	
2	168	42	2 000310402
3	180	52	2 000310403
4	191	62	2 000310404
5	200	72	2 000310405
6	221	82	2 000310406
8	235	94	2 000310408



31BM/D6	2-3-4-5-6-8 mm	1 000310420
---------	----------------	-------------

31L

pin punches, long series



Ø mm	L mm	L1 mm	
4	175	80	5 000310104
5	175	80	5 000310105
6	175	80	5 000310106

31SE

punches for spring pins



Ø mm	D mm	L mm	L1 mm	
4	2,4	175	80	5 000310204
5	3,0	175	80	5 000310205
6	3,6	175	80	5 000310206



31/B6-LSE	31L: 4-5-6 mm	1 000310320
31SE: 4-5-6 mm		
55/BV6		1 000550151

32

centre punches



Ø mm	L mm	L1 mm	
3	100	44	10 000320100
4	125	52	10 000320125
5	150	62	10 000320150

32AU

automatic centre punches



Ø mm	L mm	L1 mm	
3	150	23	2 000320160

32AUR

spare tip for automatic centre punch



Ø mm	
3	5 000320170

34

flat chisels



L mm	A mm	L1 mm	
125	14,5	45	5 000340001
150	17,0	58	5 000340002
175	21,5	68	5 000340003

35

flat chisels, ribbed type



L mm	A mm	
100	14,5	5 000350001
125	17,0	5 000350002
150	20,5	5 000350003
200	23,0	5 000350004
250	28,5	2 000350005
300	34,0	2 000350006

35PM

flat chisels, ribbed type with hand guards



L mm	A mm	
200	23,0	2 000350014
250	28,5	2 000350015
300	34,0	2 000350016

35PMR

spare hand guards



L mm	
200	1 000350024
250	1 000350025
300	1 000350026

36

cape chisels



L mm	A mm	L1 mm	
125	4	44	5 000360001
150	6	53	5 000360002

37

cape chisels, ribbed type

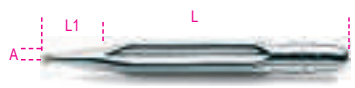

L mm	A mm	L1 mm	
150	6	45	5 000370001
200	8	55	3 000370002

37PM

cape chisel, ribbed type
with hand guard



L mm	A mm	
200	8	2 000370012

37PMR

spare hand guard



L mm	
200	1 000370022



38/B6



38/SP6

38/B6		1 000380006
30: 2-3 mm		
32: 4 mm		
34: 125-150 mm		
36: 150 mm		
42/BV6	1 000420051	
38/SP6	1 000380009	
30: 2-3 mm		
32: 4 mm		
34: 125-150 mm		
36: 150 mm		
38/SPV	1 000380019	

42

combination wrenches,
open and offset ring ends



DIN 3113 UNI-ISO 7738

mm	L mm	S1 mm	
5,5x5,5	95	3,4	5 000420005
6x6	95	3,4	5 000420006
7x7	105	3,6	5 000420007
8x8	116	3,9	5 000420008
9x9	127	4,2	5 000420009
10x10	137	4,5	5 000420010
11x11	148	4,8	5 000420011
12x12	158	5,1	5 000420012
13x13	169	5,4	5 000420013
14x14	180	5,7	5 000420014
15x15	190	6,0	5 000420015
16x16	201	6,3	5 000420016
17x17	212	6,7	5 000420017
18x18	222	7,0	5 000420018
19x19	233	7,3	5 000420019
20x20	243	7,6	3 000420020
21x21	254	7,9	3 000420021
22x22	264	8,1	3 000420022
23x23	275	8,3	3 000420023
24x24	285	8,5	3 000420024
25x25	296	8,7	2 000420025
26x26	307	8,9	2 000420026
27x27	317	9,1	2 000420027
28x28	328	9,3	2 000420028
29x29	338	9,5	2 000420029
30x30	349	9,7	2 000420030
32x32	370	10,1	2 000420032
34x34	391	10,5	1 000420034
35x35	412	10,7	1 000420035
36x36	412	10,9	1 000420036
38x38	433	11,3	1 000420038
41x41	465	12,0	1 000420041



42/B9	1 000420064
6-7-8-10-11-13-14-17-19 mm	
42/BV9	1 000420056



42/S14	1 000420067
6-7-8-10-11-12-13-14-15-16-17-19-22-24 mm	
42/S15	1 000420066
6-7-8-10-11-12-13-14-17-19-22-24-27-30-32 mm	
42/S17	1 000420065
6-7-8-9-10-11-12-13-14-15-16-17-18-19-20-21-22 mm	
42/S17X	1 000420068
6-7-8-10-11-12-13-14-15-16-17-19-21-22-24-27-30 mm	
42/S26	1 000420070
6-7-8-9-10-11-12-13-14-15-16-17-18-19-20-21-22-23-24-25-26-27-28-29-30-32 mm	

42/SC9I-E

set of 9 combination wrenches, open and offset ring ends, with compact support



42/SC9I	1 000420087
8-10-11-12-13-14-15-17-19 mm	
42/SCV9I	1 000420103
42/SC9E	1 000420088
8-10-11-12-13-16-17-18-19 mm	
42/SCV9E	1 000420104



42/SP25	1 000420085
6-7-8-9-10-11-12-13-14-15-16-17-18-19-20-21-22-23-24-25-26-27-28-30-32 mm	
42/SPV2	1 000420090



42/SP15



42/SPV...

42/SP15	1 000420078
6-7-8-9-10-11-12-13-14-15-16-17-19-22-24 mm	
42/SPV7	1 000420097
42: 8-10-11-13-14-17-19 mm	
55: 6x7-8x9-10x11-12x13-14x15-16x17-18x19 mm	
42/SPV11	1 000420100
42MP: 8-9-10-11-12-13-14-15-16-17-19 mm	
142-142SN: 8-9-10-11-12-13-14-15-16-17-19 mm	
42/SPV15	1 000420102
42: 6-7-8-9-10-11-12-13-14-15-16-17-19-22-24 mm	

42AS

combination wrenches,
open and offset ring ends



mm	L mm		
1/4x1/4	95	2	000420106
9/32x9/32	106	2	000420107
5/16x5/16	116	2	000420108
3/8x3/8	137	2	000420110
7/16x7/16	148	2	000420111
1/2x1/2	169	2	000420113
9/16x9/16	180	2	000420114
19/32x19/32	191	2	000420115
5/8x5/8	201	2	000420116
11/16x11/16	212	2	000420117
3/4x3/4	233	2	000420119
13/16x13/16	254	2	000420121
7/8x7/8	264	2	000420122
15/16x15/16	285	2	000420124
1x1	296	2	000420125
1.1/16x1.1/16	317	2	000420127
1.1/8x1.1/8	338	2	000420129
1.1/4x1.1/4	370	2	000420132
1.5/16x1.5/16	391	1	000420133
1.3/8x1.3/8	412	1	000420135
1.7/16x1.7/16	412	1	000420136
1.1/2x1.1/2	433	1	000420138



mm	L mm		
42AS/B9		1	000420155
1/4-5/16-3/8-7/16-1/2			
9/16-5/8-11/16-3/4			



mm	L mm		
42AS/13		1	000420163
1/4-5/16-3/8-7/16-1/2-9/16-5/8			
11/16-3/4-13/16-7/8-15/16-1			
42AS/16		1	000420166
1/4-5/16-3/8-7/16-1/2-9/16-5/8			
11/16-3/4-13/16-7/8-15/16-1-1.1/16-1.1/8-1.1/4			
42AS/17		1	000420168
1/4-9/32-5/16-3/8-7/16-1/2-9/16-19/32-5/8-11/16-3/4-13/16-7/8-15/16-1-1.1/16-1.1/8			

42MP

combination wrenches, open and offset
ring ends, bright chrome-plated



DIN 3113 UNI-ISO 7738

mm	L mm		
6x6	95	5	000420606
7x7	105	5	000420607
8x8	116	5	000420608
9x9	127	5	000420609
10x10	137	5	000420610
11x11	148	5	000420611
12x12	158	5	000420612
13x13	169	5	000420613
14x14	180	5	000420614
15x15	190	5	000420615
16x16	201	5	000420616
17x17	212	5	000420617
18x18	222	5	000420618
19x19	233	5	000420619
20x20	243	3	000420620
21x21	254	3	000420621
22x22	264	3	000420622
24x24	285	3	000420624
27x27	317	3	000420627
30x30	349	3	000420630
32x32	370	3	000420632



mm	L mm		
42MP/B9		1	000420651
6-7-8-10-11-13-14-17-19 mm			
42/BV9		1	000420056

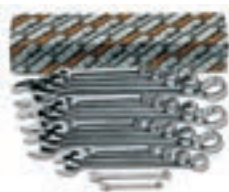

mm	L mm		
42MP/S17		1	000420652
6-7-8-9-10-11-12-13-14-15-16-17-18-19-20-21-22 mm			
42MP/S21		1	000420653
6-7-8-9-10-11-12-13-14-15-16-17-18-19-20-21-22-24-27-30-32 mm			

42LMP

combination wrenches, open and offset
ring ends, long series, bright chrome-plated



mm	L mm		
8x8	148	2	000420508
9x9	167	2	000420509
10x10	172	2	000420510
11x11	186	2	000420511
12x12	197	2	000420512
13x13	207	2	000420513
14x14	223	2	000420514
15x15	233	2	000420515

mm	L mm		
16x16	243	2	000420516
17x17	261	2	000420517
18x18	270	2	000420518
19x19	280	2	000420519
21x21	301	2	000420521
22x22	318	2	000420522
24x24	338	2	000420524
27x27	376	2	000420527
30x30	394	2	000420530
32x32	435	2	000420532



mm	L mm		
42LMP/S14		1	000420551
8-9-10-11-12-13-14-15-16-17-18-19-21-22 mm			
42LMP/S18		1	000420552
8-9-10-11-12-13-14-15-16-17-18-19-21-22-24-27-30-32 mm			

42SLIM

combination wrenches with thin open ends



DIN 3113 UNI-ISO 7738

mm	L mm	S1 mm		
8x8	116	3,4	5	000420408
10x10	137	3,8	5	000420410
11x11	148	3,8	5	000420411
12x12	158	4,2	5	000420412
13x13	169	4,4	5	000420413
14x14	180	4,6	5	000420414
15x15	190	4,7	5	000420415
16x16	201	4,7	5	000420416
17x17	212	5,1	5	000420417
18x18	222	5,1	5	000420418
19x19	233	5,6	5	000420419



mm	L mm		
42SLIM/B8I		1	000420468
10-11-12-13-14-15-17-19 mm			
42SLIM/B8E		1	000420469
10-11-12-13-16-17-18-19 mm			
42SLIM/S11		1	000420471
8-10-11-12-13-14-15-16-17-18-19 mm			

 **Beta**

 **Beta**
INOX
STAINLESS STEEL

258

45

combination wrenches,
open and offset ring ends, heavy series



DIN 3113 UNI-ISO 7738

mm	L mm		
46x46	520	1	000450046
50x50	560	1	000450050
55x55	610	1	000450055
60x60	660	1	000450060
65x65	710	1	000450065
70x70	760	1	000450070
75x75	810	1	000450075
80x80	860	1	000450080

52

single open end wrenches



UNI 6733 DIN 3114

mm	L mm		
10	119	5	000520010
11	119	5	000520011
12	119	5	000520012
13	145	5	000520013
14	145	5	000520014
15	145	5	000520015
16	159	5	000520016
17	159	5	000520017
18	159	5	000520018
19	175	5	000520019
20	175	5	000520020
21	175	5	000520021
22	196	2	000520022
23	196	2	000520023
24	196	2	000520024
25	215	2	000520025
26	215	2	000520026
27	215	2	000520027
28	240	2	000520028
30	240	2	000520030
32	270	2	000520032
34	270	1	000520034
35	295	1	000520035
36	295	1	000520036
38	295	1	000520038
40	335	1	000520040
41	335	1	000520041
42	335	1	000520042
45	370	1	000520045
46	370	1	000520046
48	370	1	000520048
50	415	1	000520050
52	415	1	000520052
55	415	1	000520055
60	490	1	000520060
65	490	1	000520065
70	490	1	000520070

Beta

53

single open end wrenches DIN 894



mm	L mm		
36	317	1	000530036
38	320	1	000530038
41	342	1	000530041
46	396	1	000530046
50	412	1	000530050
55	457	1	000530055
60	492	1	000530060
65	528	1	000530065
70	572	1	000530070
75	608	1	000530075
80	645	1	000530080
85	690	1	000530085
90	690	1	000530090
95	847	1	000530095
100	847	1	000530100
105	1000	1	000530105
110	1000	1	000530110
115	1000	1	000530115
120	1000	1	000530120
125	1000	1	000530125
130	1000	1	000530130
135	1000	1	000530135

55

double open end wrenches



UNI-ISO 10102 DIN 3110

mm	L mm		
4x5	101	5	000550003
5x5,5	101	5	000550006
5,5x7	120	5	000550009
• 6x7	120	5	000550012
7x8	140	5	000550018
• 8x9	140	5	000550021
8x10	140	5	000550024
• 10x11	155	5	000550030
10x12	155	5	000550033
10x13	170	5	000550035
• 12x13	170	5	000550042
12x14	170	5	000550045
13x14	185	5	000550047
13x17	189	5	000550051
• 14x15	185	5	000550054
14x17	189	5	000550057
• 16x17	202	5	000550060
17x19	220	2	000550063
• 18x19	220	2	000550066
19x22	236	2	000550069

mm	L mm		
• 20x22	236	2	000550075
• 21x23	245	2	000550078
22x24	245	2	000550081
• 24x26	262	2	000550087
24x27	262	2	000550090
• 25x28	272	2	000550096
• 27x29	284	2	000550099
27x30	284	2	000550102
27x32	297	2	000550105
• 30x32	297	2	000550108
32x36	325	1	000550114
34x36	325	1	000550117
35x38	375	1	000550120
36x41	375	1	000550123
41x46	425	1	000550129
46x50	475	1	000550132
50x55	500	1	000550135
55x60	500	1	000550138



mm	L mm		
55/B8	6x7-8x9-10x11-12x13 14x15-16x17-18x19 20x22 mm	1	000550158
55/BV8		1	000550159
55/B12	6x7-8x9-10x11-12x13 14x15-16x17-18x19 20x22-21x23-24x26 25x28-30x32 mm	1	000550162
55/BV12		1	000550163



mm	L mm		
55/S8	6x7-8x9-10x11-12x13 14x15-16x17-18x19 20x22 mm	1	000550174
55/S12	6x7-8x9-10x11-12x13 14x15-16x17-18x19 20x22-21x23-24x26 25x28-30x32 mm	1	000550178
55/S12X	6x7-8x9-10x11-12x13 14x15-16x17-18x19 20x22-21x23-24x27 25x28-30x32 mm	1	000550179
55/S13	6x7-8x9-10x11-12x13 14x15-16x17-18x19 20x22-21x23-24x26 25x28-27x29-30x32 mm	1	000550182

Beta

Beta



55/SP7



55/SP13

55/SP7	1	000550167
6x7-8x9-10x11-12x13 14x15-16x17-18x19 mm		
42/SPV7	1	000420097
42: 8-10-11-13-14-17-19 mm		
55: 6x7-8x9-10x11-12x13 14x15-16x17-18x19 mm		
55/SP13	1	000550186
6x7-8x9-10x11-12x13 14x15-16x17-18x19 20x22-21x23-24x26 25x28-27x29-30x32 mm		
55/SPV	1	000550190

55AS

double open end wrenches



"	L mm		
1/4x9/32	120	2	000550203
1/4x5/16	120	2	000550206
5/16x11/32	140	2	000550209
5/16x3/8	140	2	000550212
3/8x7/16	155	2	000550215
7/16x1/2	170	2	000550218
1/2x9/16	170	2	000550221
9/16x5/8	185	2	000550224
19/32x11/16	189	2	000550227
5/8x11/16	202	2	000550230
5/8x3/4	202	2	000550233
11/16x13/16	220	2	000550242
3/4x7/8	236	2	000550245
25/32x13/16	236	2	000550244
7/8x15/16	245	2	000550251
15/16x1	262	1	000550257
1x1.1/8	272	1	000550259
1.1/16x1.1/4	284	1	000550267
1.1/8x1.5/16	297	1	000550266
1.5/16x1.1/2	325	1	000550269
1.3/8x1.1/2	375	1	000550272
1.7/16x1.5/8	375	1	000550275

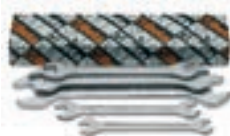

55AS/5	1	000550290
5/16x11/32-3/8x7/16 1/2x9/16-5/8x11/16 3/4x7/8		
55AS/8	1	000550296
1/4x9/32-5/16x11/32-3/8x7/16- 1/2x9/16-9/16x5/8-5/8x11/16- 11/16x13/16-3/4x7/8		
55AS/12	1	000550298
1/4x9/32-5/16x11/32-3/8x7/16-1 /2x9/16-9/16x5/8-5/8x11/16- 11/16x13/16-25/32x13/16-3/4x7/8- 15/16x1-1x1.1/8-1.1/16x1.1/4		

55MP

double open end wrenches,
bright chrome-plated



UNI-ISO 10102 DIN 3110

mm	L mm		
6x7	120	2	000550603
8x9	140	2	000550606
10x11	155	2	000550609
12x13	170	2	000550612
14x15	185	2	000550615
16x17	202	2	000550618
18x19	220	2	000550621
20x22	236	2	000550624
21x23	245	2	000550627
24x26	262	1	000550630
25x28	272	1	000550633
27x29	284	1	000550636
30x32	297	1	000550639

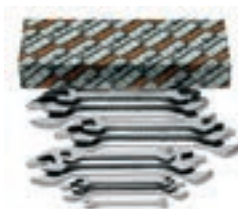

55MP/S8	1	000550650
6x7-8x9-10x11-12x13 14x15-16x17-18x19 20x22 mm		
55MP/S13	1	000550651
6x7-8x9-10x11-12x13 14x15-16x17-18x19 20x22-21x23-24x26 25x28-27x29-30x32 mm		
55MP/S12	1	000550653
6x7-8x9-10x11-12x13-14x15- 16x17-18x19-20x22-21x23-24x26- 25x28-30x32 mm		

58

open end slogging wrenches



DIN 133

mm	L mm		
24	177	1	000580024
27	180	1	000580027
30	190	1	000580030
32	190	1	000580032
34	200	1	000580034
36	215	1	000580036
41	235	1	000580041
46	255	1	000580046
50	275	1	000580050
55	300	1	000580055
60	320	1	000580060
65	342	1	000580065
70	375	1	000580070
75	375	1	000580075
80	408	1	000580080
85	408	1	000580085
90	445	1	000580090
95	445	1	000580095
100	485	1	000580100
105	485	1	000580105

mm	L mm		
110	510	1	000580110
115	510	1	000580115
120	545	1	000580120
125	545	1	000580125
130	575	1	000580130
135	575	1	000580135
*140	575	1	000580140
*145	640	1	000580145
*150	640	1	000580150
*155	640	1	000580155
*160	640	1	000580160
*165	715	1	000580165
*170	715	1	000580170
*175	715	1	000580175
*180	715	1	000580180
*185	715	1	000580185
*190	800	1	000580190
*195	800	1	000580195
*200	800	1	000580200
*210	800	1	000580210
*220	800	1	000580220
*230	800	1	000580230

73

small double open end wrenches



UNI 6737

mm	L mm		
4x4	78	5	000730040
4,5x4,5	78	5	000730045
5x5	78	5	000730050
5,5x5,5	86	5	000730055
6x6	86	5	000730060
7x7	86	5	000730070
8x8	97	5	000730080
9x9	97	5	000730090
10x10	108	5	000730100
11x11	108	5	000730110
12x12	124	5	000730120
13x13	124	5	000730130
14x14	124	5	000730140



73/B13	1	000730200
4-4,5-5-5,5-6-7-8-9 10-11-12-13-14 mm		
73/BV	1	000730201



73/S13	1	000730210
4-4,5-5-5,5-6-7-8-9 10-11-12-13-14 mm		



ring slogging wrenches



DIN 7444

mm	L mm		
24	162	1	000780024
27	180	1	000780027
30	190	1	000780030
32	190	1	000780032
34	200	1	000780034
36	205	1	000780036
41	225	1	000780041
46	235	1	000780046
50	250	1	000780050
55	265	1	000780055
60	275	1	000780060
65	295	1	000780065
70	325	1	000780070
75	325	1	000780075
80	350	1	000780080
85	350	1	000780085
90	390	1	000780090
95	390	1	000780095
100	420	1	000780100
105	420	1	000780105
110	450	1	000780110
115	450	1	000780115
120	490	1	000780120
125	480	1	000780125
130	520	1	000780130
135	520	1	000780135
*140	520	1	000780140
*145	580	1	000780145
*150	580	1	000780150
*155	580	1	000780155
*160	650	1	000780160
*165	650	1	000780165
*170	650	1	000780170
*175	650	1	000780175
*180	650	1	000780180
*185	695	1	000780185
*190	695	1	000780190
*195	695	1	000780195
*200	695	1	000780200
*210	740	1	000780210
*215	740	1	000780215
*220	740	1	000780220
*230	740	1	000780230

78AS

ring slogging wrenches



mm	L mm		
*1.1/16	180	1	000780327
*1.1/8	190	1	000780329
*1.3/16	190	1	000780330
*1.1/4	197	1	000780332
*1.5/16	197	1	000780333
*1.3/8	223	1	000780335
*1.7/16	223	1	000780336
*1.1/2	223	1	000780338
*1.5/8	223	1	000780341
*1.11/16	225	1	000780343
*1.13/16	240	1	000780346
*1.7/8	250	1	000780348
*2	250	1	000780350
*2.1/16	250	1	000780352
*2.3/16	275	1	000780355
*2.3/8	270	1	000780360
*2.9/16	302	1	000780365
*2.3/4	350	1	000780370
*2.15/16	350	1	000780375
*3.1/8	354	1	000780380

80

double swivel end socket wrenches



mm	L mm		
6x7	170	3	000800006
8x9	176	3	000800008
8x10	179	3	000800009
10x11	182	3	000800010
12x13	228	3	000800012
14x15	232	3	000800014
13x17	231	3	000800015
16x17	234	2	000800016
18x19	285	2	000800018
19x22	287	2	000800019
20x22	289	2	000800020
21x23	289	2	000800021
24x27	405	2	000800024
30x32	413	2	000800030

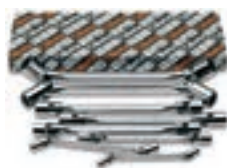

80/S8	1	000800051
6x7-8x9-10x11-12x13-14x15 16x17-18x19-20x22 mm		
80/S11	1	000800056
6x7-8x9-10x11-12x13 14x15-16x17-18x19-20x22 21x23-24x27-30x32 mm		

83

half-moon ring wrenches



ISO 3318

mm	L mm		
8x10	126	3	000830008
10x12	137	3	000830010
11x13	138	3	000830011
14x17	183	3	000830014
15x17	184	2	000830015
16x18	196	2	000830016
19x22	231	2	000830019



83/S3	1	000830081
11x13-14x17-19x22 mm		
83/S5	1	000830085
10x12-11x13-15x17 16x18-19x22 mm		

83AS

half-moon ring wrenches



"	L mm		
7/16x1/2	138	2	000830111
9/16x5/8	183	2	000830114
3/4x7/8	230	2	000830119

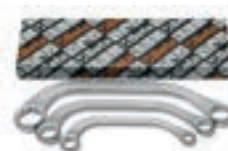

83AS/3	1	000830181
7/16x1/2-9/16x5/8 3/4x7/8		

88

double ended flat ring wrenches, extra-long series



mm	L mm		
8x10	235	2	000880008
12x14	330	2	000880012
13x15	330	2	000880013
16x18	405	2	000880016
17x19	405	2	000880017
21x23	435	2	000880021
22x24	435	2	000880022



88/S7	1	000880107
8x10-12x14-13x15-16x18- 17x19-21x23-22x24 mm		

90

double ended deep offset ring wrenches



DIN 838 ISO 10104

mm	L mm		
6x7	165	5	000900006
8x9	180	5	000900012
8x10	180	5	000900015
10x11	195	5	000900018
10x12	195	5	000900021
11x13	215	5	000900024
12x13	215	5	000900027
12x14	215	5	000900030
14x15	230	5	000900033
14x17	250	5	000900036
16x17	250	5	000900039
17x19	265	5	000900042
18x19	265	5	000900045
19x22	285	3	000900048
20x22	285	3	000900051
21x23	305	2	000900057
22x24	305	2	000900060
24x26	325	2	000900063
24x27	325	2	000900067
25x28	340	2	000900070
27x29	355	2	000900073
27x30	355	2	000900076
27x32	375	2	000900078
30x32	375	2	000900080
32x36	395	1	000900088
34x36	415	1	000900089
35x38	415	1	000900091
36x41	435	1	000900094
41x46	460	1	000900097
46x50	500	1	000900100



90/B8	1	000900154
6x7-8x9-10x11-12x13 14x15-16x17-18x19 20x22 mm		

90/BV8	1	000900155
---------------	---	-----------



90/S8	1	000900162
6x7-8x9-10x11-12x13 14x15-16x17-18x19 20x22 mm		

90/S12	1	000900166
6x7-8x9-10x11-12x13 14x15-16x17-18x19 20x22-21x23-24x26 25x28-30x32 mm		

90/S12X	1	000900167
6x7-8x9-10x11-12x13 14x15-16x17-18x19 20x22-21x23-24x27 25x28-30x32 mm		

90/S13	1	000900170
6x7-8x9-10x11-12x13 14x15-16x17-18x19 20x22-21x23-24x26 25x28-27x29-30x32 mm		



90/SP13	1	000900174
6x7-8x9-10x11-12x13 14x15-16x17-18x19 20x22-21x23-24x26 25x28-27x29-30x32 mm		

55/SPV	1	000550190
---------------	---	-----------

90AS

double ended deep offset ring wrenches



mm	L mm		
1/4x5/16	165	2	000900203
5/16x11/32	180	2	000900206
5/16x3/8	180	2	000900209
3/8x7/16	195	2	000900212
7/16x1/2	215	2	000900215
1/2x9/16	230	2	000900218
9/16x5/8	230	2	000900221
19/32x11/16	250	2	000900222
5/8x11/16	250	2	000900224
5/8x3/4	265	2	000900227
11/16x3/4	265	1	000900230
11/16x13/16	265	1	000900233
3/4x25/32	265	1	000900235
3/4x7/8	285	1	000900237
13/16x7/8	285	1	000900240
7/8x15/16	305	1	000900243
15/16x1	325	1	000900252
1.1/16x1.1/4	375	1	000900258
1.1/8x1.5/16	375	1	000900261



90AS/8	1	000900298
1/4x5/16-5/16x11/32 3/8x7/16-1/2x9/16 5/8x11/16-11/16x3/4 13/16x7/8-15/16x1		

90AS/10	1	000900300
1/4x5/16-5/16x11/32 3/8x7/16-1/2x9/16 5/8x11/16-11/16x3/4 13/16x7/8-15/16x1 1.1/16x1.1/4-1.1/8x1.5/16		



91

heavy duty offset ring wrenches



mm	Ø mm		
24	38	1	000910024
27	41	1	000910027
30	48	1	000910030
32	49	1	000910032
36	54	1	000910036
41	62	1	000910041
46	69	1	000910046
50	76	1	000910050
55	81	1	000910055
60	90	1	000910060
65	98	1	000910065
70	105	1	000910070
75	110	1	000910075
80	125	1	000910080
85	125	1	000910085
90	140	1	000910090
95	140	1	000910095
100	143	1	000910100
105	146	1	000910105

92

tubes for item 91



	L mm	91 mm	Ø mm		
92/1	460	24÷30	19	1	000920010
92/2	610	32÷41	22	1	000920020
92/3	760	46÷55	25	1	000920030
92/4	860	60÷105	30	1	000920040

93

double-ended offset ring wrench for scaffolding bolts



21x22	3	000930021
mm	L mm	
	310	

93C

ratcheting double-ended offset ring wrenches for scaffolding bolts



17x19	1	000930117
19x22	1	000930119
19x24	1	000930120
21x22	1	000930121
36x38	1	000930136
mm	L mm	
	310	
	310	
	310	
	365	
	445	

flare nut open ring wrenches



DIN 3118

mm	L mm		
8x10	140	2	000940008
9x11	153	2	000940009
10x11	153	2	000940010
11x13	175	2	000940011
12x14	175	2	000940012
13x15	175	2	000940013
14x15	175	2	000940014
14x17	195	2	000940015
17x19	212	2	000940017
19x22	228	2	000940019
22x24	242	2	000940022
24x27	260	2	000940024
30x32	300	2	000940030
36x41	320	1	000940036



94/S6	1	000940050
8x10-10x11-11x13-12x14		
17x19-19x22 mm		
94/S10	1	000940052
8x10-9x11-10x11-11x13		
12x14-17x19-19x22		
22x24-24x27-30x32 mm		

double ended flat ring wrenches



DIN 837 ISO 10103

mm	L mm		
6x7	120	3	000950161
8x9	135	3	000950162
10x11	150	3	000950163
12x13	165	3	000950164
14x15	185	3	000950165
16x17	210	3	000950166
17x19	225	3	000950167
18x19	225	2	000950168
20x22	240	2	000950169
21x23	255	2	000950170
24x26	270	2	000950171
25x28	285	2	000950172
27x29	315	2	000950173
30x32	335	2	000950174



95/S8	1	000950177
6x7-8x9-10x11-12x13		
14x15-16x17-18x19		
20x22 mm		
95/S13	1	000950179
6x7-8x9-10x11-12x13		
14x15-16x17-18x19		
20x22-21x23-24x26		
25x28-27x29-30x32 mm		

double-ended straight wrenches, for Torx® head screws



	L mm		
E6xE8	115	2	000950306
E10xE12	143	2	000950310
E14xE18	177	2	000950314
E20xE24	224	2	000950320



95FTX/S4	1	000950325
E6xE8-E10xE12		
E14xE18-E20xE24		

offset hexagon key wrenches chrome-plated



ISO 2936

mm	L mm	L1 mm		
0,9	35	8	20	000960013
1,3	39	10	20	000960014
1,5	45	15	20	000960015
2	50	17	20	000960020
2,5	57	20	20	000960025
3	64	22	20	000960030
3,5	68	25	20	000960035
4	72	28	20	000960040
4,5	78	30	20	000960045
5	83	32	20	000960050
5,5	88	35	20	000960055
6	94	37	20	000960060
7	99	40	10	000960070
8	105	43	10	000960080
9	111	46	10	000960090
10	119	49	10	000960100
11	126	52	10	000960110
12	134	56	10	000960120
13	142	62	10	000960130
14	151	69	10	000960140
16	165	75	5	000960160
17	174	79	5	000960170
19	196	88	5	000960190
22	216	100	3	000960220
24	242	112	1	000960240
27	271	125	1	000960270
30	309	140	1	000960300
32	341	155	1	000960312
36	385	174	1	000960316



96/ST6	3	000960370
2,5-3-4-5-6-8 mm		



96/BGS7	1	000960367
1,5-2-2,5-3-4-5-6 mm		



96/BG7	1	000960368
2,5-3-4-5-6-8-10 mm		



96/B8	5	000960386
2-2,5-3-4-5-6-8-10 mm		
96/B10	5	000960380
1,5-2-2,5-3-4-5-6-8-10-12 mm		
96N/BV	1	000960651



96/SC9	1	000960374
1,5-2-2,5-3-4-5-6-8-10 mm		
96/SCV	1	000960985



96/SC12	1	000960395
2-2,5-3-3,5-4-4,5-5		
6-7-8-9-10 mm		
96/SCV12	1	000960975



96N

offset hexagon key wrenches,
burnished



ISO 2936

mm	L mm	L1 mm		
0,9	32	10	20	000960409
1,3	44	12	20	000960413
1,5	46	15	20	000960415
2	51	17	20	000960420
2,5	57	20	20	000960425
3	64	22	20	000960430
3,5	68	25	20	000960435
4	72	28	20	000960440
4,5	78	30	20	000960445
5	83	32	20	000960450
6	94	37	20	000960460
7	99	40	10	000960470
8	105	43	10	000960480
9	111	46	10	000960490
10	119	49	10	000960500
11	126	52	10	000960510
12	134	56	10	000960520
13	142	62	10	000960530
14	151	69	10	000960540
16	165	72	5	000960560
17	174	79	5	000960570
19	194	88	5	000960590
22	216	99	1	000960592
24	242	111	1	000960594



96N/ST6
2,5-3-4-5-6-8 mm 3 000960640



96N/G7
2,5-3-4-5-6-8-10 mm 3 000960645
96N/G7A
1,5-2-2,5-3-4-5-6 mm 3 000960643



96N/B10
1,5-2-2,5-3-4-5-6 mm 5 000960650
96N/BV
8-10-12 mm 1 000960651



96N/SC9
1,5-2-2,5-3-4-5-6-8-10 mm 1 000960644
96N/SCV
 1 000960986



96N/SC12
2-2,5-3-3,5-4-4,5-5-6-7-8-9-10 mm 1 000960661
96N/SCV12
 1 000960976

96C/AS

offset hexagon key wrenches,
chrome-plated



"	L mm	L1 mm			g
1/16	46	16	20	000961702	1,01
3/32	53	19	20	000961706	2,70
1/8	60	22	20	000961710	5,33
5/32	67	25	20	000961714	9,33
3/16	74	28	20	000961716	14,87
7/32	81	32	20	000961718	22,00
1/4	89	35	20	000961720	31,40
5/16	103	40	10	000961724	56,16
3/8	117	45	10	000961728	91,31



96C-AS/SC9
1/16-3/32-1/8-5/32-3/16-7/32-1/4-5/16-3/8 1 000961753



96AS

offset hexagon key wrenches,
burnished



"	L mm	L1 mm		
1/30 (0,035")	44	14	20	000960698
1/20 (0,050")	44	15	20	000960701
1/16	46	16	20	000960702
5/64	50	18	20	000960704
3/32	53	19	20	000960706
7/64	57	21	20	000960708
1/8	60	22	20	000960710
9/64	64	24	20	000960712
5/32	68	25	20	000960714
3/16	75	29	20	000960716
7/32	82	32	20	000960718
1/4	89	35	20	000960720
5/16	103	40	10	000960724
3/8	117	44	10	000960728
7/16	132	49	10	000960730
1/2	149	54	10	000960732
9/16	151	69	2	000960734
5/8	165	72	1	000960736
3/4	194	88	1	000960738



96AS/SC9
1/16-3/32-1/8-5/32-3/16-7/32-1/4-5/16-3/8 1 000960743
96AS/SCV
 1 000960744



96AS/T7
3/32-1/8-5/32-3/16-7/32-1/4-5/16 3 000960740



96AS/G7
3/32-1/8-5/32-3/16-1/4-5/16-3/8 3 000960745



96AS/BG7
3/32-1/8-5/32-3/16-1/4-5/16-3/8 1 000960747



96AS/B11
1/20-1/16-5/64-3/32
1/8-5/32-3/16-7/32
1/4-5/16-3/8
96N/BV

1 000960749
1 000960651

96LC

offset hexagon key wrenches,
long series, chrome-plated



ISO 2936

mm	L mm	L1 mm	
2	101	17	20 000960320
2,5	113	20	20 000960321
3	127	22	20 000960322
3,5	138	25	20 000960323
4	142	28	20 000960324
4,5	154	28	20 000960325
5	163	32	20 000960326
6	184	37	20 000960327
7	194	40	10 000960328
8	205	43	10 000960329
9	216	46	10 000960330
10	231	49	10 000960331
12	259	56	10 000960332



96LC/SC8
2-2,5-3-4-5-6-8-10 mm
96LC/SCV

1 000960334
1 000960983



96LC/SC12
2-2,5-3-3,5-4-4,5-5
6-7-8-9-10 mm
96LC/SCV12

1 000960337
1 000960977

96L

offset hexagon key wrenches,
long series, burnished



ISO 2936

mm	L mm	L1 mm	
2	99	15	20 000960820
2,5	110	17	20 000960825
3	124	19	20 000960830
3,5	135	21	20 000960835
4	138	24	20 000960840
4,5	150	25	20 000960845
5	158	27	20 000960850
6	178	31	20 000960860
7	187	33	10 000960870
8	197	35	10 000960880
9	207	37	10 000960890
10	221	39	10 000960900
12	247	44	10 000960920



96L/SC8
2-2,5-3-4-5-6-8-10 mm
96L/SCV

1 000960924
1 000960987



96L/SC12
2-2,5-3-3,5-4-4,5-5
6-7-8-9-10 mm
96L/SCV12

1 000960929
1 000960978

96BPC

ball head offset hexagon key wrenches
chrome-plated

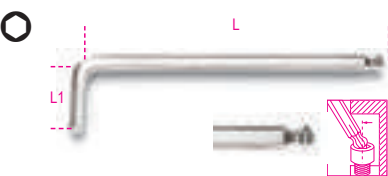

mm	L mm	L1 mm	
1,5	79	13	10 000960340
2	84	15	10 000960341
2,5	89	17	10 000960342
3	99	19	10 000960343
4	108	24	10 000960344
5	126	27	10 000960345
6	148	31	10 000960346
7	157	33	5 000960353
8	168	35	5 000960347
10	187	39	5 000960348
12	220	55	5 000960352



96BPC/SC9
1,5-2-2,5-3-4-5-6-8-10 mm
96BPC/SCV

1 000960354
1 000960984

96BP

ball head offset hexagon key wrenches
burnished

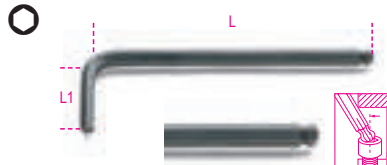

mm	L mm	L1 mm	
1,5	79	13	10 000960960
2	84	15	10 000960961
2,5	89	17	10 000960962
3	99	19	10 000960963
4	108	24	10 000960965
5	126	27	10 000960967
6	148	31	10 000960968
8	168	35	5 000960970
10	187	39	5 000960972
12	220	55	5 000960973



96BP/SC9
1,5-2-2,5-3-4-5-6-8-10 mm
96BP/SCV

1 000960974
1 000960988

96LBP

ball head offset hexagon key wrenches,
extra-long model

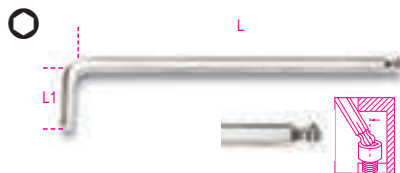

mm	L mm	L1 mm	
1,5	90	15	5 000961340
2	100	17	5 000961341
2,5	112	20	5 000961342
3	127	22	5 000961343
4	144	27	5 000961344
5	163	32	5 000961345
6	184	37	5 000961346
8	204	44	2 000961348
10	230	49	2 000961350



96LBP/SC9 1 000961354
1,5-2-2,5-3-4-5-6-8-10 mm
96LBP/SCV 1 000961984

96BP/AS

ball head offset hexagon wrenches
burnished

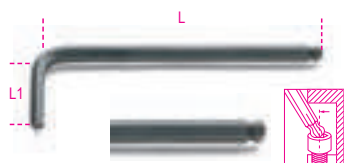

"	L mm	L1 mm		
3/32	89	17	10	000960989
1/8	98	18	10	000960990
5/32	108	24	10	000960991
3/16	126	26	10	000960992
7/32	139	28	10	000960993
1/4	152	31	10	000960994
5/16	168	34	5	000960995
3/8	190	39	5	000960996



96BP-AS/SC9 1 000961000
1/16-3/32-1/8-5/32-3/16
7/32-1/4-5/16-3/8
96BP-AS/SCV 1 000961001



96BP-AS/8 1 000960997
3/32-1/8-5/32-3/16-7/32
1/4-5/16-3/8
96BP-AS/BV 1 000960998

96BPA

ball head offset hexagon key wrenches, 110°,
extra-short side model



mm	L mm	L1 mm		
1,5	71	9	5	000961960
2	86	11	5	000961961
2,5	96	13	5	000961962
3	104	15	5	000961963
4	116	17	5	000961964
5	132	19	5	000961965
6	155	21	5	000961966
8	176	24	2	000961968
10	200	27	2	000961970



96BPA/SC9 1 000961974
1,5-2-2,5-3-4-5-6-8-10 mm
96BPA/SCV 1 000961988

96T

offset hexagon key wrenches,
with high torque handles

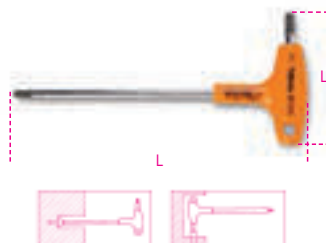

mm	L mm	L1 mm		
2	139	52	5	000960934
2,5	153	55	5	000960935
3	153	55	5	000960936
3,5	179	70	5	000960937
4	179	70	5	000960938
4,5	200	84	5	000960939
5	200	84	5	000960940
6	221	103	5	000960941
7	236	106	3	000960942
8	255	117	3	000960943
10	285	132	3	000960945



96T/S6 1 000960952
2-2,5-3-4-5-6 mm
96T/S8 1 000960933
2-2,5-3-4-5-6-8-10 mm
96T/S11 1 000960951
2-2,5-3-3,5-4-4,5-5-6-7-8-10 mm



96T/SP11 1 000960957
2-2,5-3-3,5-4-4,5-5
6-7-8-10 mm
96T/SPV 1 000960958
96T/S11
97TTX/S11

96T/AS

offset hexagon key wrenches,
with high torque handles

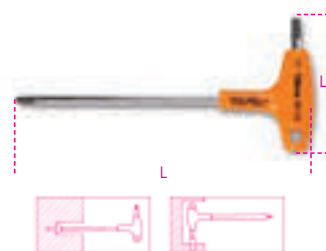

"	L mm	L1 mm		
3/32	153	55	2	000960669
7/64	153	55	2	000960670
1/8	179	70	2	000960671
9/64	179	70	2	000960672
5/32	200	84	2	000960673
3/16	200	84	2	000960674
7/32	221	103	2	000960675
1/4	236	106	2	000960676
5/16	255	117	2	000960678
3/8	285	132	2	000960680



96T/AS8 1 000960682
3/32-7/64-1/8-5/32-3/16-
1/4-5/16-3/8
96T/AS10 1 000960683
3/32-7/64-1/8-9/64-5/32
3/16-7/32-1/4-5/16-3/8

Beta

Beta INOX STAINLESS STEEL

258

96TBP

ball head offset hexagon key wrenches with high torque handles



	L	L1		
mm	mm	mm		
2,5	153	55	3	000960685
3	153	55	3	000960686
4	179	70	3	000960687
5	200	84	3	000960688
6	221	103	3	000960689
8	255	117	2	000960690
10	285	132	2	000960692



96TBP/S6
2,5-3-4-5-6-8 mm

97TX

offset key wrenches, for Torx® head screws



	L	L1		
mm	mm	mm		
T6	42	16	5	000970006
T7	48	16	5	000970007
T8	48	16	5	000970008
T9	48	16	5	000970009
T10	51	17	5	000970010
T15	54	18	5	000970015
T20	57	19	5	000970020
T25	60	20	5	000970025
T27	64	21	5	000970027
T30	70	24	5	000970030
T40	76	26	5	000970040
T45	83	29	5	000970045
T50	95	32	5	000970050
T55	108	35	5	000970055
T60	120	38	5	000970060



97TX/ST8
T9-T10-T15-T20-T25
T27-T30-T40



97TX/G8
T9-T10-T15-T20-T25
T27-T30-T40



97TX/BG8
T9-T10-T15-T20-T25-T27-T30-T40



97TX/SC8
T9-T10-T15-T20-T25
T27-T30-T40
97TX/SCV



97TX/B13
T6-T7-T8-T9-T10-T15-T20
T25-T27-T30-T40-T45-T50
96N/BV

97BTX

ball head offset key wrenches, for Torx® head screws

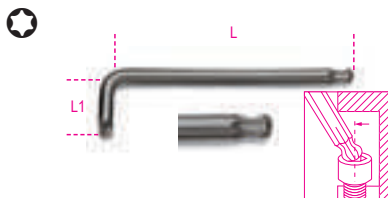

	L	L1		
mm	mm	mm		
T9	80	16	5	000970109
T10	86	17	5	000970110
T15	90	18	5	000970115
T20	95	19	5	000970120
T25	100	20	5	000970125
T27	105	21	5	000970127
T30	114	24	5	000970130
T40	124	26	5	000970140
T45	133	28	5	000970145
T50	152	32	3	000970150
T55	164	35	3	000970155



97BTX/SC8
T9-T10-T15-T20-T25-T27-T30-T40
97BTX/SCV



97BTX/B8
T9-T10-T15-T20-T25
T27-T30-T40
96N/BV

97BTXL

ball head offset key wrenches, long model, for Torx® head screws

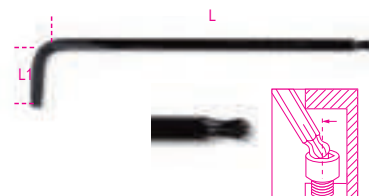

	L	L1		
mm	mm	mm		
T9	80	15	3	000970309
T10	86	17	3	000970310
T15	100	18	3	000970315
T20	110	19	3	000970320
T25	126	20	3	000970325
T27	140	24	3	000970327
T30	160	28	3	000970330
T40	176	32	3	000970340



97BTXL/SC8
T9-T10-T15-T20-
T25-T27-T30-T40
97BTXL/SCV

97RTX

offset key wrenches for Tamper Resistant Torx® head screws



	L	L1		
mm	mm	mm		
T9	56	16	5	000970209
T10	62	17	5	000970210
T15	72	17	5	000970215
T20	83	18	5	000970220
T25	90	18	5	000970225
T27	100	20	5	000970227
T30	105	24	5	000970230
T40	112	26	5	000970240



97RTX/SC8 T9-T10-T15-T20-T25 T27-T30-T40	1	000970263
97RTX/SCV	1	000970984



97RTX/B8 T9-T10-T15-T20-T25 T27-T30-T40	1	000970260
96N/BV	1	000960651

97TTX

offset key wrenches with handles for Torx® head screws

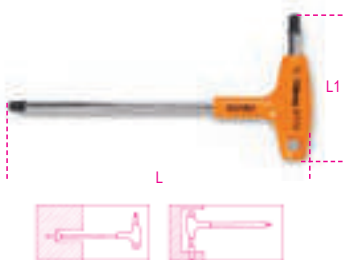

	L mm	L1 mm		
T6	130	52	3	000970706
T7	130	52	3	000970707
T8	139	52	3	000970708
T9	139	52	3	000970709
T10	179	70	3	000970710
T15	179	70	3	000970715
T20	179	70	3	000970720
T25	179	70	3	000970725
T27	200	84	3	000970727
T30	200	84	3	000970730
T40	221	103	3	000970740
T45	236	106	2	000970745
T50	255	117	2	000970750



97TTX/S6 T10-T15-T20-T25-T30-T40	1	000970791
97TTX/S8 T8-T10-T15-T20-T25- T27-T30-T40	1	000970808
97TTX/S11 T8-T9-T10-T15-T20-T25 T27-T30-T40-T45-T50	1	000970800
97TTX/S13 T6-T7-T8-T9-T10-T15-T20-T25 T27-T30-T40-T45-T50	1	000970813



97TTX/SP11 T8-T9-T10-T15-T20-T25 T27-T30-T40-T45-T50	1	000970840
96T/SPV 96T/S11 97TTX/S11	1	000960958

98XZN

offset key wrenches with XZN® profile



DIN 65253

	L mm	L1 mm		
M5	83	25	5	000980005
M6	89	30	5	000980006
M8	97	32	5	000980008
M10	106	35	5	000980010
M12	116	37	5	000980012
M14	118	45	5	000980014
M16	125	45	5	000980016



98XZN/B5 M5-M6-M8-M10-M12	1	000980650
96N/BV	1	000960651

99

hook wrenches with square noses, for ring nuts UNI/ISO 2982, 2983



UNI 6752

	A mm		
12-14	1,5	3	000990012
16-18-20	1,8	3	000990016
22-25-28	1,8	3	000990022
30-32	2,1	3	000990030
34-36-38	2,4	3	000990034
40-42	2,4	3	000990040
45-50	2,5	3	000990045
52-55-58	2,5	3	000990052
62-65	3,1	3	000990062
68-70-75	3,1	3	000990068
80-85-90	3,8	2	000990080
92-95	4,3	2	000990092
98-100	4,3	2	000990098
105-110-115	4,4	1	000990105
120-125-130	4,9	1	000990120
135-145	6,0	1	000990135
155-165	6,0	1	000990155

99SQ

hook wrenches with square noses for ring nuts



	B mm		
15-35	2,7	2	000990215
35-50	3,5	2	000990235
50-80	4,7	2	000990250
80-120	6,2	2	000990280
120-180	7,8	2	000990290

99ST

hook wrenches with round noses for ring nuts



	Ø mm	B mm		
15-35	3,0	2,5	2	000990315
35-50	4,0	4,5	2	000990335
50-80	5,0	5,0	2	000990350
80-120	6,0	7,0	2	000990380
120-180	8,0	9,0	2	000990390

99 VN/...

spare nose for item 99ST

	Ø mm		
99ST VN/15	15-35	1	000990295
99ST VN/35	35-50	1	000990296
99ST VN/50	50-80	1	000990297
99ST VN/80	80-120	1	000990298
99ST VN/120	120-180	1	000990299

100

round pin wrench for ring nuts with front holes



Ø mm	L mm	Ø min-max mm		
4,9-5,9	250	18÷100	1	001000001
6,9-7,9				

100/KIT

spare pins for item 100



100/KIT	1	001000010
----------------	---	-----------

111

adjustable wrenches with scales, chrome-plated

- Right-hand rotation of pin
- With mm and inch scale



DIN 3117 ISO 6787

L mm	L "	A max mm	⚙️	📄
100	4	15	3	001110010
150	6	24	3	001110015
200	8	28	3	001110020
250	10	34	3	001110025
300	12	35	3	001110030
380	15	45	3	001110038
450	18	54	2	001110045
600	24	62	1	001110060

111N

adjustable wrenches with scales, phosphatized

- Left-hand rotation of pin
- With mm and inch scale



DIN 3117 ISO 6787

L mm	L "	A max mm	⚙️	📄
100	4	15	3	001110210
150	6	24	3	001110215
200	8	28	3	001110220
250	10	34	3	001110225
300	12	35	3	001110230
380	15	45	3	001110238
450	18	54	2	001110245

111G

adjustable wrenches with scales
chrome-plated

- Right-hand rotation of pin
- Mm and inch scale
- Ergonomic handle



DIN 3117 ISO 6787

L mm	L "	A max mm	⚙️	📄
200	8	28	3	001110620
250	10	34	3	001110625
300	12	35	2	001110630

120

ratchet opening single ended
bi-hex wrenches



⊙ mm	L mm	⚙️	📄
10	135	1	001200010
11	135	1	001200011
12	135	1	001200012
13	135	1	001200013
14	135	1	001200014
17	185	1	001200017
19	185	1	001200019
22	230	1	001200022
24	230	1	001200024
27	230	1	001200027
30	320	1	001200030
32	320	1	001200032



120/B6 10-11-13 17-19-22 mm	1	001200050
120/BV	1	001200051

123E1/4

bit holder adaptor, 1/4", for 10 mm ratcheting
wrenches

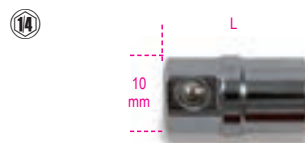

⊙ mm	L mm	⚙️	📄
10	20,6	1	001230010

123Q1/4

quick release adaptor, 1/4", for 10 mm
ratcheting wrenches

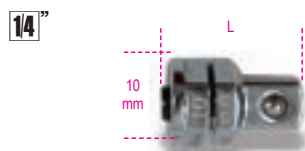

⊙ mm	L mm	⚙️	📄
10	17,5	1	001230310

123Q3/8

quick release adaptor, 3/8", for 13 mm
ratcheting wrenches

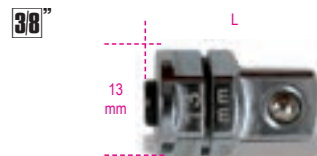

⊙ mm	L mm	⚙️	📄
13	22,5	1	001230313

123Q1/2

quick release adaptor, 1/2", for 19 mm
ratcheting wrenches

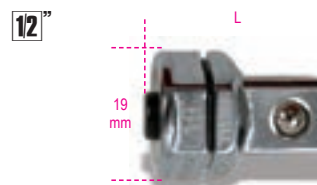

⊙ mm	L mm	⚙️	📄
19	30,5	1	001230319

123/K4

kit with 4 adapters for ratchet wrenches:
1 bit adapter
3 quick release adapters



123/K4	1	001230504
--------	---	-----------

141

ratcheting combination wrenches, straight
series



⊙ mm	L mm	⚙️	📄
8x8	136	3	001410008
9x9	143	3	001410009
10x10	160	3	001410010
11x11	168	3	001410011
12x12	174	3	001410012
13x13	180	3	001410013
14x14	193	2	001410014
15x15	200	2	001410015
16x16	216	2	001410016
17x17	233	2	001410017
18x18	239	2	001410018
19x19	250	2	001410019



141/B6 1 001410066
8-10-13-14-17-19 mm



141/S12 1 001410072
8-9-10-11-12-13-14-15-16-17-18-19 mm

142
reversible ratcheting
combination wrenches



mm	L mm		
6x6	136	3	001420006
7x7	136	3	001420007
8x8	136	3	001420008
9x9	143	3	001420009
10x10	159	3	001420010
11x11	168	3	001420011
12x12	174	3	001420012
13x13	180	3	001420013
14x14	190	2	001420014
15x15	200	2	001420015
16x16	216	2	001420016
17x17	233	2	001420017
18x18	239	2	001420018
19x19	248	2	001420019
21x21	285	1	001420021
22x22	285	1	001420022
24x24	325	1	001420024
27x27	355	1	001420027
30x30	420	1	001420030
32x32	420	1	001420032
34x34	482	1	001420034
36x36	482	1	001420036
38x38	482	1	001420038

* Straight model without inverter



142/B6 1 001420066
8-10-13-14-17-19 mm
142/BV6 1 001420076
142/B9 1 001420069
8-10-11-12-13-14-15-17-19 mm
142/BV9 1 001420079



142/S15 1 001420074
6-7-8-9-10-11-12-13-14-15-16-17-18-19-22 mm
142/S17 1 001420068
6-7-8-10-11-12-13-14-15-16-17-18-19-21-22-24-27 mm
142/S19 1 001420075
6-7-8-9-10-11-12-13-14-15-16-17-18-19-22-24-27-30-32 mm

142/SC9-E
set of 9 reversible ratcheting combination
wrenches, with compact support



142/SC9I 1 001420087
8-10-11-12-13-14-15-17-19 mm
142/SCV9I 1 001420103
142/SC9E 1 001420088
8-10-11-12-13-16-17-18-19 mm
142/SCV9E 1 001420104

142AS
reversible ratcheting
combination wrenches



"	L mm		
5/16x5/16	136	2	001420308
3/8x3/8	159	2	001420310
7/16x7/16	168	2	001420311
1/2x1/2	180	2	001420313
9/16x9/16	190	2	001420314
5/8x5/8	216	2	001420316
11/16x11/16	233	2	001420317
3/4x3/4	248	2	001420319



142AS /8 1 001420330
5/16-3/8-7/16-1/2-9/16-5/8-11/16-3/4

142C
ratcheting combination wrenches,
straight short series



mm	L mm		
8x8	88	2	001420108
9x9	96	2	001420109
10x10	96	2	001420110
11x11	100	2	001420111
12x12	104	2	001420112
13x13	108	2	001420113
14x14	114	2	001420114
15x15	118	2	001420115
16x16	122	2	001420116
17x17	128	2	001420117
18x18	132	2	001420118
19x19	138	2	001420119



142C/A12 1 001420175
8-9-10-11-12-13-14-15-16-17-18-19 mm

142SN
swivel end ratcheting
combination wrenches



mm	L mm		
7x7	136	2	001420207
8x8	136	2	001420208
9x9	143	2	001420209
10x10	160	2	001420210
11x11	168	2	001420211
12x12	174	2	001420212
13x13	180	2	001420213
14x14	193	2	001420214
15x15	200	2	001420215
16x16	216	2	001420216
17x17	233	2	001420217
18x18	239	2	001420218
19x19	250	2	001420219
22x22	285	1	001420222
24x24	325	1	001420224



142SN/S13 1 001420263
7-8-9-10-11-12-13-14-15-16-17-18-19 mm

186

self-locking wrench with automatic take-up device
for hexagons, 8 to 32 mm

Ideal for hexagon, Spline, square and Torx® head screws, including damaged screws.



L mm		
260	1	001860008

187

swivelling, openable wrenches



mm	L mm	
8x9	125	1 001870008
10x11	155	1 001870010
12x13	175	1 001870012
14x15	205	1 001870014
16x17	235	1 001870016



187/B5		
8x9-10x11-12x13		1 001870050
14x15-16x17 mm		

188

ratcheting flat bi-hex ring wrenches
for free alternator pulleys



mm	L mm	
10	240	2 001880010
15	322	2 001880015

192

reversible ratcheting double-ended flat bi-hex ring wrenches, 4 in 1



mm	L mm	
8x10/12x13	160	1 001920008
16x17/18x19	230	1 001920016

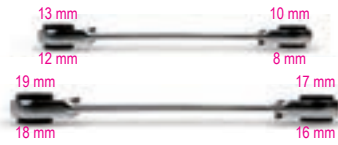

192/S2		
8x10/12x13 mm		1 001920070
16x17/18x19 mm		

194

reversible ratcheting wrench
for bits



mm	L mm	
1/4x5/16	128	2 001940006

195

ratcheting double-ended flat bi-hex ring
wrenches



mm	L mm	
8x10	128	2 001950010
12x13	170	2 001950013
14x15	190	2 001950015
16x18	230	2 001950018
17x19	230	2 001950019



195/B5		
8x10-12x13-14x15		1 001950066
16x18-17x19 mm		
195/BV5		1 001950070

195AS

ratcheting double-ended flat bi-hex ring
wrenches



mm	L mm	
5/16x3/8	128	2 001950606
7/16x1/2	170	2 001950611
9/16x5/8	190	2 001950614
11/16x3/4	230	2 001950617



195AS/B4		
5/16x3/8 - 7/16x1/2 -		1 001950654
9/16x5/8 - 11/16x3/4		
195FTX/BV4		1 001950520

195P

reversible ratcheting double-ended offset
bi-hex ring wrenches, bent at 15°



mm	L mm	
8x10	128	2 001950210
12x13	170	2 001950213
14x15	190	2 001950215
16x18	230	2 001950218
17x19	230	2 001950219



195P/B5		
8x10-12x13-14x15		1 001950266
16x18-17x19 mm		
195/BV5		1 001950070

310

polywelder for PE, PP, PVC
and PVDF pipes and fittings

CE



230V-650 Watt
50 Hz+60Hz
Schuko (CEE 7/7)

	∅ mm	
310/1	16÷50	1 003100001
310/2	16÷63	1 003100002

310B

forms for polywelder item 310



∅ mm	
16	1 003100016
20	1 003100020
25	1 003100025
32	1 003100032
40	1 003100040
50	1 003100050
63	1 003100063



310/C4

polywelder with assortment of 3 forms



310/C4	1	003100104
310/1+310B: Ø 20-25-32		
410x260x82 mm - 4,8 kg		

310/C8

polywelder with assortment of 7 forms



310/C8	1	003100108
310/2+310B: Ø 16-20-25		
32-40-50-63		
440x270x120 mm - 7,7 kg		

311

heating plates for manual straight and slanted welding of PE, PP, PVC and PVDF pipes

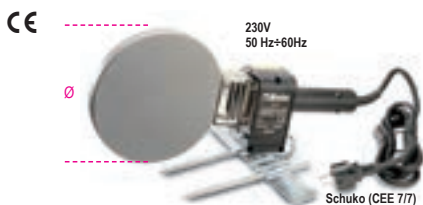

311/1	Ø mm	Watt	1	003110001
311/2	120	300	1	003110002
	190	900	1	003110002

330

pipe cutters for steel gas pipes



330/2	Ø mm - "	L mm	1	003300002
330/4	10÷60 1/8"÷ 2"	380	1	003300004
	60÷115 2"÷ 4"	585	1	003300004

330R/A

spare cutters for item 330 wheels for steel pipes



330R/A2	Ø mm	S mm	1	003300012
330R/A4	32	7	1	003300014
	42	9	1	003300014

330R/I

spare cutter wheel for item 330 for stainless steel pipes



330R/I2	Ø mm	S mm	1	003300024
330R/I4	32	7	1	003300034
	32	9	1	003300034

331L

ratcheting pipe cutter for copper and light alloy pipes



8÷29	Ø mm - "	L mm	1	003310008
5/16"÷1"1/8		180	1	003310008

331LR/L

spare knife for pipe cutter 331L



331LR/L	Ø mm	1	003310058
	18	1	003310058

332

mini pipe cutter for copper and light alloy pipes



3÷16	Ø mm - "	L mm	2	003320001
1/8"÷5/8"		59	2	003320001

334

pipe cutter for copper and light alloy pipes

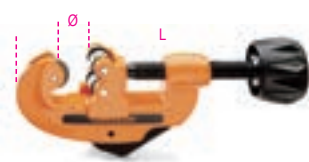

3÷30	Ø mm - "	L mm	1	003340001
1/8"÷1"1/8		150	1	003340001

334R

spare cutter wheel for items 332 and 334 for copper and light alloy pipes

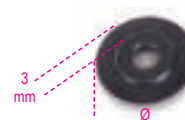

334R	Ø mm	1	003340021
	18	1	003340021

334R/I

spare cutter wheel for items 332 and 334 for stainless steel pipes

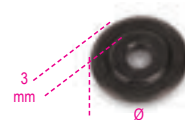

334R/I	Ø mm	1	003340023
	18	1	003340023

336

telescopic pipe cutter for copper and light alloy pipes



6÷38	Ø mm - "	L mm	1	003360001
1/4"÷1"1/2		160	1	003360001

338

telescopic pipe cutter, fast advance for copper, light alloys and plastic pipes



6÷67	Ø mm - "	L mm	1	003380001
1/4"÷2"5/8		290	1	003380001

338R

spare cutter wheel for items 331L, 336 and 338 for copper and light alloy pipes



338R
Ø mm 18,5
1 003380022

338R/I

spare cutter wheel for items 336 and 338 for stainless steel pipes

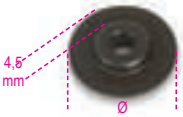

338R/I
Ø mm 21,8
1 003380023

338RP

spare cutter wheel for items 336 and 338 for plastic pipes



338RP
Ø mm 21,9
1 003380025

339A

telescopic pipe cutter, fast advance for plastic pipes



339A
Ø mm - " 50±127
L mm 345
2"÷ 5"
1 003390011

339A/R

spare cutter wheels for item 339A



339A/R
Ø mm 42
1 003390061

340

multilayer pipe cutting pliers, max. Ø 26 mm
PTFE-coated blade
4 support rollers making it easier to rotate pipe during cutting jobs
system for cutting corrugated pipes built into handle
lightweight magnesium body



340
Ø max mm 26
1 003400001

340RL

spare blade for item 340



340RL
1 003400010

341

pipe cutting pliers for plastic pipes



341
Ø mm 0÷25
L mm 190
1 003410001

341RL

spare blade for item 341



341RL
1 003410010

341B

ratchet-type shears for plastic pipes



341B
Ø mm 0÷35
L mm 195
1 003410051

341B/RM

spare spring for item 341B

341B/RM
1 003410061

341B/RL

spare blade for item 341B



341B/RL
1 003410060

342

Ratchet-type shears for plastic pipes



342
Ø mm - " 0÷42
L mm 200
1"5/8
1 003420030

342MOL

spare spring for item 342

342MOL
1 003420033

342RL

spare blade for item 342



342RL
1 003420032



342A

ratchet-type shears for plastic pipes



Ø mm -" 0÷50 2"	L mm 270	1	003420101

342A/MOL

spare spring for item 342A

342A/MOL	1	003420111

342A/RL

spare blade for item 342A



342A/RL	1	003420110

342P

ratchet-type shears for plastic pipes, made from magnesium alloy



Ø mm -" 0÷50 2"	L mm 260	1	003420121

342P/RL

spare blade for item 342P



342P/RL	1	003420130

345

pipe reamer metal body



Ø mm -" 3÷42 1/8"÷1"5/8	L mm 58	5	003450001

345U

pipe reamer for stainless steel, steel, copper and light alloys



Ø mm -" 4÷36 5/32÷1"7/16	L mm 60	1	003450050

345C

multilayer pipe gauge



Ø mm 16-20-26-32	1	003450032

345SB

deburrer with revolving replacement blade



L mm 150	5	003450010

345SB/R

spare blade for item 345SB



345SB/R	3	003450015

349

tube flaring tool with clutch, for copper and light alloy pipes

38"



Ø mm -" 6-8-10-12-14-15-16-18 (1/8-3/16-1/4-5/16 3/8-1/2-5/8-3/4)	1	003490001
270x200x50 mm - 2,7 kg		

349/SMM

metric slide for item 349



Ø mm 6-8-10-12-14-15-16-18	1	003490011

349/SMAS

inch slide for item 349



Ø " 1/8-3/16-1/4-5/16 3/8-1/2-5/8-3/4	1	003490012

350

tube flaring tool for copper and light alloy pipes



Ø mm 4-4,75-6-8 10-12-14	L mm 175	A mm 104	1	003500001

351C

pipe cutter and tube flaring tool



351C	1	003510010

334	Ø 3÷30 mm (1/8"÷1"1/8)
350	Ø 4÷14 mm
351P	Ø 4-4,75-6-8-10-12-14 mm
225x150x45 mm - 1,6 kg	

351P

inserts for tube flaring tool item 350



	∅ mm		
351P 4	4	3	003510101
351P 4,75	4,75	3	003510102
351P 6	6	3	003510103
351P 8	8	3	003510104
351P 10	10	3	003510105
351P 12	12	3	003510106
351P 14	14	3	003510107

352U

adjustable tube flaring tool
for copper and light alloy pipes

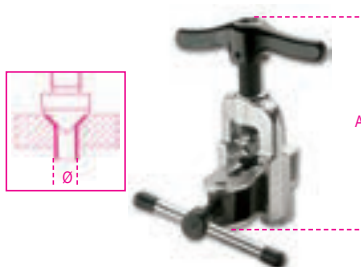

∅ mm - "	A mm		
5÷16 3/16÷5/8	130	1	003520101

352C/U

pipe cutter, deburrer and adjustable tube
flaring tool



352C/U		1	003520110

334 ∅ 3÷30 mm (1/8"÷1 1/8")

345SB

352U ∅ 5÷16 mm (3/16"÷5/8")

335x145x60 mm - 2120 g

353N

tube expanding pliers,
with interchangeable forms



L mm			
380		1	003530201

353NM

forms for tube expanding pliers
item 353N

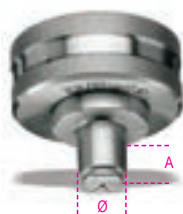

∅ mm	A mm		
10	7	1	003530210
12	10	1	003530212
14	10	1	003530214
16	12	1	003530216
18	12	1	003530218
22	13	1	003530222

353N/C6

tube expanding pliers item 353N
with forms item 353NM



353N/C6		1	003530300

353N

353NM ∅ 10-12-14-16-18-22 mm

420x185x60 mm - 2,2 kg

355

combination spud wrench, five steps



∅ "	L mm		
3/8"-1/2"	90	2	003550001
3/4"-1"			

357F3

three-vial spirit level



∅ "	L mm	A mm		
3/8" / 1/2"	90÷220		1	003570100

357R/F3

spare vial for item 357F3



357R/F3		1	003570101

358

tools for chamfering plastic pipes



	∅ mm		
358/1	16÷110	1	003580001
358/2	40÷250	1	003580002

358RL

spare blade for items 358/1 and 358/2



358RL		1	003580011

359

universal drain wrench



∅ "	L mm	A mm		
1"÷1 1/4"	160	140	1	003590001

359CH

drain adaptor, cross-shape for item 359



Ø "	L mm		
1 1/2	74	1	003590005

360

pipe wrenches, Stillson pattern



L mm	Ø max "	Ø max mm		
250	1" gas	34	1	003600025
350	1 1/2 gas	49	1	003600035
450	2" gas	60	1	003600045
600	2 1/2 gas	76	1	003600060
900	3 1/2 gas	102	1	003600090

360R/...

spare parts kit for item 360
with moving jaw and ring nut.

360R250	1	003600225
360R350	1	003600235
360R450	1	003600245
360R600	1	003600260
360R900	1	003600290

362

heavy duty pipe wrenches



L mm	Ø max "	Ø max mm		
200	1" gas	34	1	003620020
250	1 1/2 gas	49	1	003620025
300	2" gas	60	1	003620030
350	2" gas	60	1	003620035
450	2 1/2 gas	76	1	003620045
600	3" gas	90	1	003620060
900	5" gas	140	1	003620090

362R/...

spare parts kit for item 362
with: fixed jaw, moving jaw; ring nut; lockpin.

362R 200	1	003620220
362R 250	1	003620225
362R 300	1	003620230
362R 350	1	003620235
362R 450	1	003620245
362R 600	1	003620260
362R 900	1	003620290

363

heavy duty pipe wrenches
made from light alloy



L mm	Ø max "	Ø max mm		
350	2" gas	60	1	003630035
450	2 1/2 gas	76	1	003630045
600	3" gas	90	1	003630060
900	5" gas	140	1	003630090
1200	6" gas	165	1	003630120

363R/...

spare parts kit for item 363
with: fixed jaw; moving jaw; ring nut; lockpin.

363R 350	1	003630235
363R 450	1	003630245
363R 600	1	003630260
363R 900	1	003630290
363R 1200	1	003630320

365

heavy duty pipe wrenches,
offset pattern made from light alloy



L mm	Ø max "	Ø max mm		
350	2" gas	60	1	003650035
450	2 1/2 gas	76	1	003650045

365R/...

spare parts kit for item 365
with: fixed jaw; moving jaw; ring nut; lockpin.

365R 350	1	003650235
365R 450	1	003650245

366

pipe wrenches, light pattern



L mm	Ø max "	Ø max mm		
175	1" gas	34	1	003660017
225	1 1/2 gas	49	1	003660022
275	2" gas	60	1	003660027
300	2 1/2 gas	76	1	003660030
350	3" gas	90	1	003660035

374

pipe wrenches,
Swedish pattern, 45° slim jaws



DIN 5234

L mm	Ø max "	Ø max mm		
240	1/2" gas	21	1	003740024
320	1" gas	34	1	003740032
410	1 1/2 gas	49	1	003740041
550	2" gas	60	1	003740055
630	3" gas	90	1	003740063

375

pipe wrench, Swedish pattern,
45° flat jaws



DIN 5234

L mm	Ø max "	Ø max mm		
320	1" gas	34	1	003750032
410	1 1/2 gas	49	1	003750041
550	2" gas	60	1	003750055

376

pipe wrenches,
Swedish pattern, 90° flat jaws



DIN 5234

L mm	Ø max "	Ø max mm		
320	1" gas	34	1	003760032
410	1 1/2 gas	49	1	003760041
550	2" gas	60	1	003760055
630	3" gas	90	1	003760063

378

pipe wrenches,
Swedish pattern, 45° slim jaws



DIN 5234

L mm	Ø max "	Ø max mm		
250	1/2" gas	21	1	003780025
320	1" gas	34	1	003780032
410	1 1/2 gas	49	1	003780041
550	2" gas	60	1	003780055
650	3" gas	90	1	003780065

374R/...

complete spare parts kit for items 374 - 375
- 376 - 378

with ring nut and ring nut stop

374R 240 x 374/240-378/250	1	003740724
374R 320 x 374/320-376/320-378/320	1	003740732
374R 410 x 374/410-375/410-376/410-378/410	1	003740741
374R 550 x 374/550-376/550-378/550	1	003740755
374R 630 x 374/630-378/650	1	003740763

383

reversible strip pipe wrenches



	∅ max"	∅ max mm	L mm		
383/1	3"	gas	90	300	1 003830001
383/2	8"	gas	220	300	1 003830002

383R

spare strips for item 383



	S mm		
383R/1	27	1	003830010
383R/2	27	1	003830015

384

reversible chain pipe wrench



	∅ max"	∅ max mm	L mm		
4"	gas	115	300	1	003840032

384RC

spare chain for item 384



384RC	1	003840033
-------	---	-----------

386A

heavy duty reversible
chain pipe wrenches



	∅ max	L mm		
386A/3	4" gas 115 mm	900	1	003860003
386A/4	6" gas 168 mm	900	1	003860004
386A/5	8" gas 220 mm	1100	1	003860005
386A/6	12" gas 324 mm	1300	1	003860006

386A/RC

spare chains for item 386A



386A3/RC	1	003860013
386A4/RC	1	003860014
386A5/RC	1	003860015
386A6/RC	1	003860016

388

pipe benders for thin walled copper,
light alloy and mild steel pipes

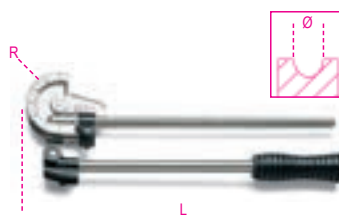

∅ mm	L mm	R mm		
6	305	18,0	1	003880006
8	315	23,5	1	003880008
10	350	31,0	1	003880010
12	360	31,0	1	003880012
14	455	46,5	1	003880014
15	465	46,5	1	003880015
16	465	46,5	1	003880016

388A

pipe bending pliers for thin walled
copper and light alloy pipes



	∅ mm	L mm		
388A/1	6-8-10 mm	220	1	003880051
388A/2	1/4"-5/16"-3/8"	220	1	003880055

388C/C8

pipe bender with 7 forms
for thin walled copper and light alloy pipes



	∅ mm		
388C/C8	10-12-14-16 18-20-22	1	003880200

400x330x110 mm - 3,6 kg

392C

adjustable drain tap pliers



∅ mm	L mm		
25-65	260	1	003920100

392RG/C

spare jaw protectors for item 392C, pair



392RG/C	1	003920101
---------	---	-----------

393

water tap wrench



L mm		
270	1	003930001

395

hinged water tap wrench

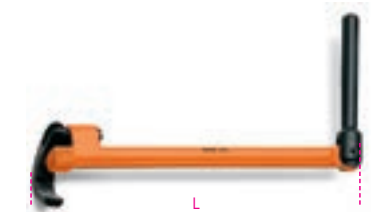

∅ mm	L mm		
15-32 mm 5/8"÷1"1/4	240	1	003950001

395T

telescopic hinged water tap wrench



Ø	L		
mm	mm		
10÷32 mm	250÷430	1	003950100
3/8"÷1"1/4			

399

pivoting clamp vices

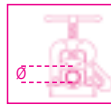

Ø	L min		
mm	mm		
10÷60 mm	220	1	003990005
1/8÷2"			
10÷89 mm	290	1	003990010
1/8÷3"			

399R/...

spare kit for item 399
composed of two lower jaws and one upper jaw



399RG1/8-2"	1	003990105
399RG1/8-3"	1	003990110

410

twist drills with cylindrical shanks,
short series HSS, rolled

R ≤ 650 N/mm²
HV ~ 750÷820



DIN 338 ISO 235

Ø	L	L1		
mm	mm	mm		
0,50	22	6	10	004100030
1,00	34	12	10	004100040
1,25	38	16	10	004100043
1,50	40	18	10	004100046
1,75	46	22	10	004100049
2,00	49	24	10	004100052
2,25	53	27	10	004100055
2,50	57	30	10	004100058
2,75	61	33	10	004100061
3,00	61	33	10	004100064
3,20	65	36	10	004100066

Ø	L	L1		
mm	mm	mm		
3,25	65	36	10	004100067
3,50	70	39	10	004100070
3,75	70	39	10	004100073
4,00	75	43	10	004100076
4,20	75	43	10	004100078
4,25	75	43	10	004100079
4,50	80	47	10	004100082
4,75	80	47	10	004100085
5,00	86	52	10	004100088
5,25	86	52	10	004100091
5,50	93	57	10	004100094
5,75	93	57	10	004100097
6,00	93	57	10	004100100
6,25	101	63	10	004100103
6,50	101	63	10	004100106
6,75	109	69	10	004100109
7,00	109	69	10	004100112
7,50	109	69	10	004100118
8,00	117	75	10	004100124
8,50	117	75	10	004100130
9,00	125	81	5	004100136
9,50	125	81	5	004100142
10,00	133	87	5	004100148
10,50	133	87	5	004100172
11,00	142	94	5	004100184
11,50	142	94	5	004100196
12,00	151	101	5	004100210
12,50	151	101	5	004100222
13,00	151	101	5	004100234
14,00	160	108	5	004100242
15,00	169	114	5	004100250
16,00	178	120	5	004100258
17,00	186	125	3	004100262
18,00	194	130	3	004100266
19,00	202	135	3	004100270
20,00	210	140	3	004100274



410/SP19	1	004100419
Ø 1÷10 x 0,5 mm		
410/SPV1	1	004100420
410/SP25	1	004100425
Ø 1÷13 x 0,5 mm		
410/SPV2	1	004100426



410/SEL19	1	004100418
Ø 1÷10 x 0,5 mm		

410MIX/SEL19

set of 13 twist drills, item 410,
and 6 twist drills with hard metal insets



410MIX/SEL19	1	004100417
--------------	---	-----------



Ø 1 - 1,5 - 2 - 2,5 - 3 - 3,5 - 4
4,5 - 5 - 5,5 - 6 - 8 - 10 mm

Ø 4 - 5 - 6 - 8 - 9 - 10 mm

410A

twist drills with cylindrical shanks,
short series, HSS, rolled

R ≤ 650 N/mm²
HV ~ 750÷820



DIN 338 ISO 235

Ø	L	L1		
mm	mm	mm		
13,50	160	108	5	004100281
14,00	160	108	5	004100283
14,50	169	114	5	004100285
15,00	169	114	5	004100287
15,50	178	120	5	004100289
16,00	178	120	5	004100291
16,50	186	125	3	004100292
17,00	186	125	3	004100293
17,50	194	130	3	004100294
18,00	194	130	3	004100295
18,50	202	135	3	004100296
19,00	202	135	3	004100297
19,50	210	140	3	004100298
20,00	210	140	3	004100299

410AS

twist drills with cylindrical shanks,
short series HSS, rolled

R ≤ 650 N/mm²
HV ~ 750÷820



ANSI B94

Ø	L	L1		
"	mm	mm		
1/16	48	22	10	004100371
5/64	51	25	10	004100372
3/32	57	32	10	004100373
7/64	67	38	10	004100374
1/8	70	41	10	004100375
9/64	73	44	10	004100376
5/32	79	51	10	004100377
11/64	83	54	10	004100378
3/16	89	59	10	004100379
13/64	92	62	10	004100380
7/32	95	64	10	004100381
15/64	98	67	10	004100382
1/4	102	70	10	004100383
17/64	105	73	10	004100384
9/32	108	75	10	004100385
19/64	111	78	10	004100386
5/16	114	81	10	004100387
21/64	117	84	10	004100388
11/32	121	87	5	004100389
23/64	124	89	5	004100390
3/8	127	92	5	004100391



410AS/SP21
 Ø 1/16-5/64-3/32-7/64
 1/8-9/64-5/32-11/64-3/16
 13/64-7/32-15/64-1/4
 17/64-9/32-19/64-5/16
 21/64-11/32-23/64-3/8
410AS/SPV1

1 004100429
 1 004100430



410AS/SEL21
 Ø 1/16-5/64-3/32-7/64
 1/8-9/64-5/32-11/64-3/16
 13/64-7/32-15/64-1/4
 17/64-9/32-19/64-5/16
 21/64-11/32-23/64-3/8

1 004100433

412
 twist drills with cylindrical shanks,
 short series HSS entirely ground glossy
 finishing

R ≤ 700 N/mm²
 HV ~ 750÷820



DIN 338 ISO 235

Ø mm	L mm	L1 mm		
0,50	22	6	10	004120030
1,00	34	12	10	004120040
1,25	38	16	10	004120043
1,50	40	18	10	004120046
1,75	46	22	10	004120049
2,00	49	24	10	004120052
2,25	53	27	10	004120055
2,50	57	30	10	004120058
2,75	61	33	10	004120061
3,00	61	33	10	004120064
3,25	65	36	10	004120067
3,50	70	39	10	004120070
3,75	70	39	10	004120073
4,00	75	43	10	004120076
4,25	75	43	10	004120079
4,50	80	47	10	004120082
4,75	80	47	10	004120085
5,00	86	52	10	004120088
5,25	86	52	10	004120091
5,50	93	57	10	004120094
5,75	93	57	10	004120097
6,00	93	57	10	004120100
6,25	101	63	10	004120103
6,50	101	63	10	004120106
6,75	109	69	10	004120109
7,00	109	69	10	004120112
7,25	109	69	5	004120115

Ø mm	L mm	L1 mm		
7,50	109	69	5	004120118
7,75	117	75	5	004120121
8,00	117	75	5	004120124
8,25	117	75	5	004120127
8,50	117	75	5	004120130
8,75	125	81	5	004120133
9,00	125	81	5	004120136
9,25	125	81	5	004120139
9,50	125	81	5	004120142
9,75	133	87	5	004120145
10,00	133	87	5	004120148
10,25	133	87	5	004120149
10,50	133	87	5	004120150
10,75	142	94	5	004120151
11,00	142	94	5	004120152
11,25	142	94	5	004120153
11,50	142	94	5	004120154
11,75	142	94	5	004120155
12,00	151	94	5	004120156
12,25	151	101	5	004120157
12,50	151	101	5	004120158
12,75	151	101	5	004120159
13,00	151	101	5	004120160



412/SP19	Ø 1÷10 x 0,5 mm	1	004120419	
412/SPV1		1	004120420	
412/SP25	Ø 1÷13 x 0,5 mm	1	004120425	
412/SPV2		1	004120426	
412/SP49	Ø 1÷13 x 0,25 mm	1	004120449	
412/SPV4		1	004120451	

412/C150



412/C150		1	004120450	
412	Ø 3 mm	n.		20
	Ø 1 - 1,5 - 2 - 2,5 - 3 - 3,5 - 4 - 4,5 - 5 mm			10
	Ø 5,5 - 6 - 6,5 - 7 - 7,5 - 8 - 8,5 - 9 - 9,5 - 10 mm			5

365x230x47 mm - 3,3 kg



412/SP91
 Ø 1÷10 x 0,10 mm
 1 004120452

412A

twist drills with cylindrical shanks,
 short series, HSS entirely ground
 burnished
 R ≤ 700 N/mm²
 HV ~ 750÷820



DIN 338 ISO 235

Ø mm	L mm	L1 mm		
13,50	160	108	3	004120202
14,00	160	108	3	004120204
14,50	169	114	3	004120206
15,00	169	114	3	004120208
15,50	178	120	3	004120210
16,00	178	120	3	004120212
16,50	186	125	1	004120213
17,00	186	125	1	004120214
17,50	194	130	1	004120215
18,00	194	130	1	004120216
18,50	202	135	1	004120217
19,00	202	135	1	004120218
19,50	210	140	1	004120219
20,00	210	140	1	004120220

412L

twist drills with cylindrical shanks,
 long series, HSS entirely ground
 burnished
 R ≤ 700 N/mm²
 HV ~ 750÷820



DIN 340

Ø mm	L mm	L1 mm		
2,00	85	56	10	004120232
2,50	95	62	10	004120234
3,00	100	66	10	004120236
3,50	112	73	10	004120238
4,00	119	78	10	004120240
4,50	126	82	10	004120242
5,00	132	87	10	004120244
5,50	139	91	10	004120246
6,00	139	91	10	004120248
6,50	148	97	5	004120250
7,00	156	102	5	004120252
8,00	165	109	5	004120256
9,00	175	115	5	004120260
10,00	184	121	5	004120264

414

twist drills with cylindrical shanks,
short series, HSS-TiN entirely ground

R ≤ 900 N/mm²
HV 0,05 ~ 2500



DIN 338 ISO 235

Ø mm	L mm	L1 mm		
1,00	34	12	10	004140040
1,25	38	16	10	004140042
1,50	40	18	10	004140046
1,75	46	22	10	004140048
2,00	49	24	10	004140052
2,25	53	27	10	004140054
2,50	57	30	10	004140058
2,75	61	33	10	004140060
3,00	61	33	10	004140064
3,25	65	36	10	004140066
3,50	70	39	10	004140070
3,75	70	39	10	004140072
4,00	75	43	10	004140076
4,25	75	43	10	004140078
4,50	80	47	10	004140082
4,75	80	47	10	004140084
5,00	86	52	10	004140088
5,25	86	52	10	004140090
5,50	93	57	10	004140094
5,75	93	57	10	004140096
6,00	93	57	10	004140100
6,25	101	63	10	004140102
6,50	101	63	10	004140106
6,75	109	69	10	004140108
7,00	109	69	10	004140112
7,25	109	69	5	004140114
7,50	109	69	5	004140118
7,75	117	75	5	004140120
8,00	117	75	5	004140124
8,25	117	75	5	004140125
8,50	117	75	5	004140130
8,75	125	81	5	004140132
9,00	125	81	5	004140136
9,25	125	81	5	004140138
9,50	125	81	5	004140142
9,75	133	87	5	004140144
10,00	133	87	5	004140148
10,50	133	87	5	004140150
11,00	142	94	5	004140152
11,50	142	94	5	004140154
12,00	151	101	5	004140156
12,50	151	101	5	004140158
13,00	151	101	5	004140160



414/SP19	Ø 1÷10 x 0,5 mm	1	004140419
414/SPV1		1	004140420
414/SP25	Ø 1÷13 x 0,5 mm	1	004140425
414/SPV2		1	004140426
414/SP49	Ø 1÷13 x 0,25 mm	1	004140429
414/SPV4		1	004140430

414/C116



414/C116 1 004140450

414	Ø 1 - 1,5 - 2 - 2,5 - 3 - 3,5 - 4 - 4,5 - 5 mm	n.
	Ø 5,5 - 6 - 6,5 - 7 - 7,5 - 8 mm	3
	Ø 8,5 - 9 - 9,5 - 10 mm	2

365x230x47 mm - 2,7 Kg

415

twist drills with cylindrical shanks,
short series, HSS-CO 8%
entirely ground

R ≤ 1400 N/mm²
HV ~ 850+920



DIN 338 ISO 235

Ø mm	L mm	L1 mm		
0,50	22	6	10	004150029
1,00	34	12	10	004150040
1,25	38	16	10	004150043
1,50	40	18	10	004150046
1,75	46	22	10	004150049
2,00	49	24	10	004150052
2,25	53	27	10	004150055
2,50	57	30	10	004150058
2,75	61	33	10	004150061
3,00	61	33	10	004150064
3,25	65	36	10	004150067
3,50	70	39	10	004150070
3,75	70	39	10	004150073
4,00	75	43	10	004150076
4,25	75	43	10	004150079
4,50	80	47	10	004150082
4,75	80	47	10	004150085
5,00	86	52	10	004150088
5,25	86	52	10	004150091
5,50	93	57	10	004150094
5,75	93	57	10	004150097
6,00	93	57	10	004150100
6,25	101	63	10	004150103
6,50	101	63	10	004150106
6,75	109	69	10	004150109
7,00	109	69	10	004150112
7,25	109	69	5	004150115
7,50	109	69	5	004150118
7,75	117	75	5	004150121
8,00	117	75	5	004150124
8,25	117	75	5	004150127
8,50	117	75	5	004150130
8,75	125	81	5	004150133
9,00	125	81	5	004150136
9,25	125	81	5	004150139
9,50	125	81	5	004150142
9,75	133	87	5	004150145
10,00	133	87	5	004150148
10,25	133	87	5	004150149
10,50	133	87	5	004150150
10,75	142	94	5	004150151
11,00	142	94	5	004150152
11,25	142	94	5	004150153
11,50	142	94	5	004150154
11,75	142	94	5	004150155
12,00	151	101	5	004150156
12,25	151	101	5	004150157
12,50	151	101	5	004150158
12,75	151	101	5	004150159
13,00	151	101	5	004150160

Ø mm	L mm	L1 mm		
14,00	160	108	3	004150164
15,00	169	114	3	004150168
16,00	178	120	3	004150172
17,00	186	125	1	004150174
18,00	194	130	1	004150176
19,00	202	135	1	004150178
20,00	210	140	1	004150180



415/SP19	Ø 1÷10 x 0,5 mm	1	004150419
415/SPV1		1	004150420
415/SP25	Ø 1÷13 x 0,5 mm	1	004150425
415/SPV2		1	004150426
415/SP49	Ø 1÷13 x 0,25 mm	1	004150431
415/SPV4		1	004150432

415/C116



415/C116 1 004150450

415	Ø 1 - 1,5 - 2 - 2,5 - 3 - 3,5 - 4 - 4,5 - 5 mm	n.
	Ø 5,5 - 6 - 6,5 - 7 - 7,5 - 8 mm	3
	Ø 8,5 - 9 - 9,5 - 10 mm	2

365x230x47 mm - 2,7 kg



415/SP91	Ø 1÷10 x 0,10 mm	1	004150460
----------	------------------	---	-----------

416

drill with cylindrical shank, specially ground, with two cutter pairs

R ≤ 900 N/mm²
HV || 820÷850

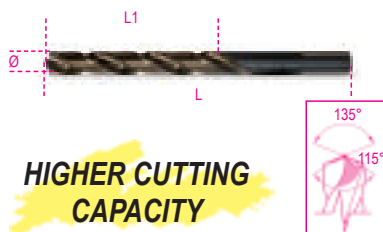

HIGHER CUTTING CAPACITY

DIN 338

Ø mm	L mm	L1 mm		
1,00	34	12	10	004160010
1,50	40	18	10	004160015
2,00	49	24	10	004160020
2,50	57	30	10	004160025
3,00	61	33	10	004160030
3,50	70	39	10	004160035
4,00	75	43	10	004160040
4,50	80	47	10	004160045
5,00	86	52	10	004160050
5,50	93	57	10	004160055
6,00	93	57	10	004160060
6,50	101	63	10	004160065
7,00	109	69	10	004160070
7,50	109	69	5	004160075
8,00	117	75	5	004160080
8,50	117	75	5	004160085
9,00	125	81	5	004160090
9,50	125	81	5	004160095
10,00	133	87	5	004160100

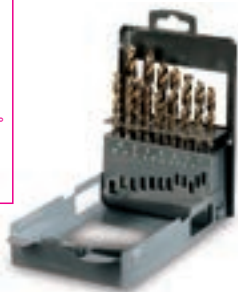
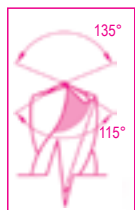

416/SP19
Ø 1÷10 x 0,5 mm

1 004160419

417

helical cylindrical masonry drill bits, short series, made from milled steel with hard metal plates



DIN 8039

Ø mm	L mm		
3	70	10	004170003
4	75	10	004170004
5	85	10	004170005
5L	150	5	004170105
6	100	10	004170007
6L	150	5	004170106
7	120	10	004170009
8	120	10	004170010
8L	200	5	004170113
9	120	10	004170011
10	120	10	004170012
10L	200	5	004170120
12	150	10	004170014
12L	200	5	004170125
14	150	5	004170016
16	150	5	004170018



417/SP8
Ø 3-4-5-6-8-9-10-12 mm

1 004170100

419

hammer drill bits with milled shanks and hard metal plates



DIN 8039

Ø mm	L mm		
4	110	10	004190002
5	110	10	004190004
5	160	10	004190006
6	110	10	004190012
6	160	10	004190014
6	210	10	004190016
7	160	10	004190028
8	110	10	004190030
8	160	10	004190032
8	210	10	004190034
8	260	10	004190036
8	460	10	004190042
9	160	5	004190044
10	160	5	004190050
10	210	5	004190052
10	260	5	004190054
10	310	5	004190056
10	460	5	004190060
12	160	5	004190064
12	210	5	004190066
12	260	5	004190068
12	460	5	004190074
14	160	3	004190086
14	260	3	004190090
14	310	3	004190092
14	460	3	004190096
16	210	3	004190112
16	250	3	004190114
16	300	3	004190116
16	450	3	004190120
18	250	1	004190124
20	310	1	004190128

421

countersinks with guide pins, fine grade, made of HSS



DIN 373

M	L mm	Ø mm	D1 mm	D mm		
3	71	6	3,2	5	1	004210003
4	71	8	4,3	5	1	004210004
5	80	10	5,3	8	1	004210005
6	80	11	6,4	8	1	004210006
8	100	15	8,4	12,5	1	004210008
10	100	18	10,5	12,5	1	004210010
12	100	20	13,0	12,5	1	004210012



421/SP6
M 3-4-5-6-8-10

1 004210019

421/SPV

1 004210020

422

ground centre drill bits, 60° countersink angle, made of HSS

• For quick, safe centre holes



DIN 333/A

Ø mm	D mm	L mm		
1,60	4,0	35,5	1	004220116
2,50	6,3	45,0	1	004220125
3,15	8,0	50,0	1	004220131

423

special end mills for welding HSS ground



Ø mm	L mm		
6	66	5	004230006
7	74	5	004230007
8	79	5	004230008
10	89	5	004230010

 **Beta**

423A

special mills for spot welding,
HSS ground



DIN 1412/E

Ø mm	L mm		
6,5	40	1	004230015
8,0	40	1	004230020

424

conical drill bits, HSS

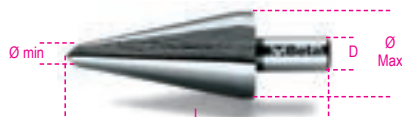

	L mm	Ø mm	D mm		
424/1	58	3÷14	6	2	004240001
424/2	63	6÷20	8	2	004240002
424/3	60	16÷30	10	2	004240003
424/4	80	3÷22	8	1	004240004
424/5	102	3÷31	10	1	004240005
424/6	86	26÷40	13	1	004240006
424/7	89	36÷50	13	1	004240007
424/8	90	40÷61	13	1	004240008



424/SP3	1	004240019
424/1+424/2+424/3		
Ø 3÷30 mm		
424/SPV	1	004240020

425

stepped drills, HSS



	L mm	Ø mm	S mm	D mm		
425/1	70	4÷12	1	6	2	004250010
425/2	55	4÷12	2	6	2	004250012
425/3	85	4÷20	2	10	2	004250015
425/4	85	12÷20	1	10	1	004250016
425/5	97	20÷30	1	10	1	004250017
425/6	75	4÷30	2	10	1	004250020
425/7	97	30÷40	1	13	1	004250025
425/8	100	40÷50	1	13	1	004250029



425/SP3	1	004250030
425/1+425/3+425/6		
Ø 4÷30 mm		
425/SPV	1	004250035

426

countersinking cutters
with three cutters, HSS



DIN 335-C

GR	Ø mm	L mm	Ø1 mm		
1	4,3	44	4	3	004260001
2	5,3	44	4	3	004260002
3	6,3	44	5	3	004260003
4	7,3	44	6	3	004260004
5	8,3	50	6	3	004260005
6	9,4	50	6	3	004260006
7	10,4	54	6	3	004260007
8	12,4	54	8	3	004260008
9	15,0	56	10	3	004260009
10	16,5	60	10	3	004260010
11	20,5	63	10	3	004260011
12	25,0	66	10	3	004260012
13	28,0	71	12	3	004260013
14	31,0	71	12	3	004260014



426/SP6	1	004260030
GR 3-5-7-8-10-11		
Ø 6,3÷20,5 mm		
426/SPV	1	004260035

426SB

countersinking cutters, HSS



	GR	Ø mm	D mm	L mm		
426/SB1	1	2÷5	6	45	1	004260101
426/SB2	2	5÷10	8	48	1	004260102
426/SB3	3	10÷15	10	65	1	004260103
426/SB4	4	15÷20	12	85	1	004260104
426/SB5	5	20÷25	15	102	1	004260105
426/SB6	6	25÷30	15	115	1	004260106



426SB/SP4	1	004260130
426/SB1-426/SB2		
426/SB3-426/SB4		
Ø 2÷20 mm		
426SB/SPV1	1	004260135

426MD-3/CP3

mini rotary cutters made from hard metal

• Smooth cross cut with chip breaker



L mm	Ø mm		
38,1	3	1	004260332

426MD-3/CT3

mini rotary cutters made from hard metal

• Smooth cross cut with chip breaker



L mm	Ø mm		
37,8	3	1	004260333

426MD-3/F3

mini rotary cutters made from hard metal

• Smooth cross cut with chip breaker



L mm	Ø mm		
38,3	3	1	004260334

426MD-3/FA3

mini rotary cutters made from hard metal

• Smooth cross cut with chip breaker



L mm	Ø mm		
38,2	3	1	004260339

426MD-3/OG3

mini rotary cutters made from hard metal

• Smooth cross cut with chip breaker



L mm	Ø mm		
38,1	3	1	004260337

426MD-3/OV3

mini rotary cutters made from hard metal

- Smooth cross cut with chip breaker



426MD-3/S3

mini rotary cutters made from hard metal

- Smooth cross cut with chip breaker



426MD-3/T3

mini rotary cutters made from hard metal

- Smooth cross cut with chip breaker



426MD-3/TA3

mini rotary cutters made from hard metal

- Smooth cross cut with chip breaker



1	004260349
426MD-3/A9	
426MD-3/OV3 - 426MD-3/CP3	
426MD-3/CT3 - 426MD-3/F3	
426MD-3/TA3 - 426MD-3/T3	
426MD-3/OG3 - 426MD-3/S3	
426MD-3/FA3	

426MD/CP

rotary files, made from hard metal

cross cut HM6



426MD/CT

rotary files, made from hard metal

cross cut HM6

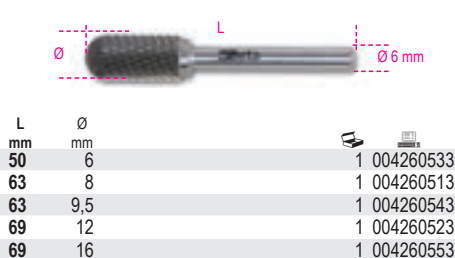

426MD/F

rotary files, made from hard metal

cross cut HM6

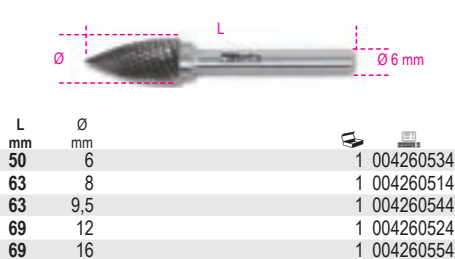

426MD/FA

rotary files, made from hard metal

cross cut HM6

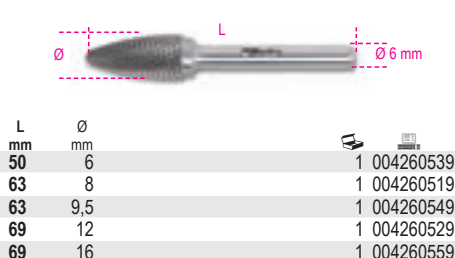

426MD/OG

rotary files, made from hard metal

cross cut HM6

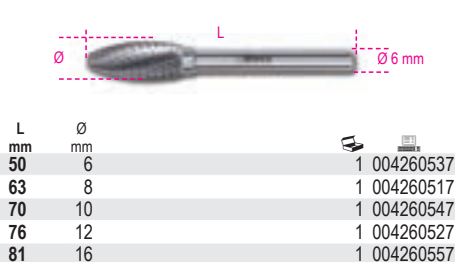

426MD/OV

rotary files, made from hard metal

cross cut HM6

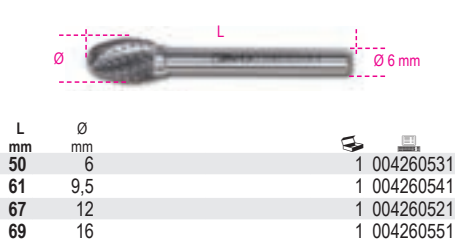

426MD/S

rotary files, made from hard metal

cross cut HM6

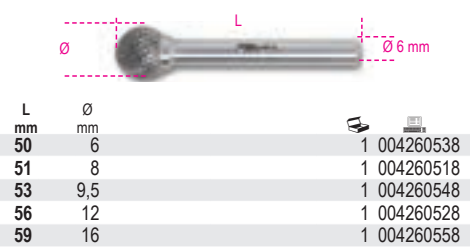

426MD/T

rotary files, made from hard metal

cross cut HM6



426MD/TA

rotary files, made from hard metal

cross cut HM6

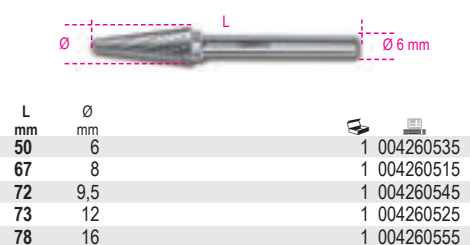

1	004260510
426MD/SP10	
426MD/CP-426MD/CT-426MD/F	
426MD/T-426MD/S	
Ø 8-12 mm	



427

morse taper extractors



DIN 317

GR	L mm	A mm		
0	92	13	3	004270000
1-2	140	19	3	004270002
3	190	25	3	004270003
4	225	30	3	004270004
5-6	260	35	3	004270006

428FP

machine taps for clearance holes,
coarse pitch threads, HSS



ISO 529

M	mm	L mm	L1 mm		
3x0,5	2,7	56	11	10	004280003
4x0,7	3,4	63	13	10	004280004
5x0,8	4,9	70	16	10	004280005
6x1	4,9	80	19	10	004280006
8x1,25	6,2	90	22	10	004280008
10x1,5	8,0	100	24	10	004280010
12x1,75	7,0	110	29	5	004280012
14x2	9,0	110	30	5	004280014
16x2	9,0	110	30	5	004280016
18x2,5	11,0	125	34	3	004280018
20x2,5	12,0	140	34	3	004280020
22x2,5	14,5	140	34	3	004280022
24x3	14,5	160	38	3	004280024

428FC

machine taps for blind holes,
coarse pitch threads, HSS

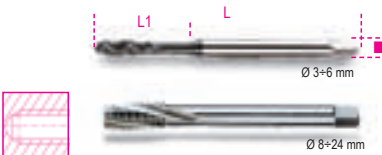

ISO 529

M	mm	L mm	L1 mm		
3x0,5	2,7	56	11	10	004280103
4x0,7	3,4	63	13	10	004280104
5x0,8	4,9	70	16	10	004280105
6x1	4,9	80	19	10	004280106
8x1,25	6,2	90	22	10	004280108
10x1,5	8,0	100	24	10	004280110
12x1,75	7,0	110	29	5	004280112
14x2	9,0	110	30	5	004280114
16x2	9,0	110	30	5	004280116
18x2,5	11,0	125	34	3	004280118
20x2,5	12,0	140	34	3	004280120
22x2,5	14,5	140	34	3	004280122
24x3	14,5	160	38	3	004280124

428/C14

assortment of 14 machine taps
items 428FP + 428FC



428/C14	1	004280201
428FP M3÷12		
428FC M3÷12		
428/SPV	1	004280202

429FP

machine taps for clearance holes,
coarse pitch threads HSS-CO 5%



ISO 529

M	mm	L mm	L1 mm		
3x0,5	2,7	56	11	5	004290003
4x0,7	3,4	63	13	5	004290004
5x0,8	4,9	70	16	5	004290005
6x1	4,9	80	19	5	004290006
8x1,25	6,2	90	22	5	004290008
10x1,5	8,0	100	24	5	004290010
12x1,75	7,0	110	29	5	004290012
14x2	9,0	110	30	5	004290014

429FC

machine taps for blind holes,
coarse pitch threads HSS-CO 5%

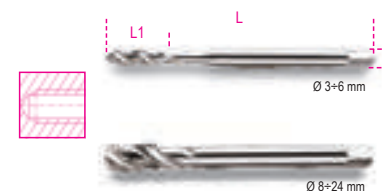

ISO 529

M	mm	L mm	L1 mm		
3x0,5	2,7	56	11	5	004290103
4x0,7	3,4	63	13	5	004290104
5x0,8	4,9	70	16	5	004290105
6x1	4,9	80	19	5	004290106
8x1,25	6,2	90	22	5	004290108
10x1,5	8,0	100	24	5	004290110
12x1,75	7,0	110	29	5	004290112
14x2	9,0	110	30	5	004290114

429/C14

assortment of 14 machine taps
items 429FP + 429FC



429/C14	1	004290201
429FP M3÷12		
429FC M3÷12		
428/SPV	1	004280202

430

hand taps, coarse pitch, metric thread
made from chrome-steel



ISO 529

M	mm	L mm	L1 mm		
2x0,4	2,5	36	11	5	004300002
3x0,5	2,5	40	12	5	004300003
4x0,7	3,0	45	14	5	004300004
5x0,8	4,0	48	16	5	004300005
6x1	5,0	50	18	5	004300006
7x1	4,5	50	18	5	004300007
8x1,25	5,0	56	22	3	004300008
9x1,25	5,5	63	22	3	004300009
10x1,5	6,0	70	25	3	004300010
11x1,5	7,0	70	25	3	004300011
12x1,75	7,0	75	30	3	004300012
14x2	8,0	80	32	3	004300014
16x2	10,0	80	32	3	004300016
18x2,5	11,0	95	40	1	004300018
20x2,5	12,0	95	40	1	004300020
22x2,5	14,5	100	40	1	004300022
24x3	14,5	110	50	1	004300024



430/SP21	1	004300201
M 3-4-5-6-8-10-12		
430/SPV	1	004300202

430ASW

hand taps, **Whitworth** thread
made from chrome-steel



DIN 352

BSW	mm	L	L1		
1/8x40	2,7	40	12	5	004300031
5/32x32	3,4	45	14	5	004300032
3/16x24	4,3	48	18	5	004300033
1/4x20	4,9	50	22	5	004300034
5/16x18	4,9	56	25	3	004300035
3/8x16	5,5	70	28	3	004300036
7/16x14	6,2	70	30	3	004300037
1/2x12	7,0	75	32	3	004300038
9/16x12	9,0	80	32	1	004300039
5/8x11	9,0	80	38	1	004300040
3/4x10	11,0	95	40	1	004300041
7/8x9	14,5	100	40	1	004300042
1"x8	16,0	110	50	1	004300043

430ASC

hand taps, **UNC** thread
made from chrome-steel



ANSI B.1.

UNC	mm	L	L1		
1/4x20	4,9	70	30	5	004300051
5/16x18	4,9	70	30	5	004300052
3/8x16	5,5	75	35	3	004300053
7/16x14	6,2	80	40	3	004300054
1/2x13	7,0	85	45	3	004300055
9/16x12	9,0	90	45	3	004300056
5/8x11	9,0	100	47	3	004300057
3/4x10	11,0	110	50	3	004300058
7/8x9	14,5	120	60	1	004300059
1"x8	16,0	130	60	1	004300060

431

hand taps, **coarse pitch**,
metric thread HSS



DIN 352 UNI 4535

M	mm	L	L1		
3x0,5	2,5	40	12	5	004310003
4x0,7	3,0	45	14	5	004310004
5x0,8	4,0	48	16	5	004310005
6x1	5,0	50	18	5	004310006
7x1	5,0	50	18	5	004310007
8x1,25	5,0	56	22	3	004310008

M	mm	L	L1		
10x1,5	6,0	70	25	3	004310010
12x1,75	7,0	75	30	3	004310012
14x2	9,0	80	32	1	004310014
16x2	9,0	80	32	1	004310016
18x2,5	11,0	95	40	1	004310018
20x2,5	12,0	95	40	1	004310020
22x2,5	12,0	100	40	1	004310022
24x3	14,5	110	50	1	004310024



431/SP21 1 004310201

M 3-4-5-6-8-10-12

431/SPV 1 004310202

433

hand taps, **fine pitch**, metric thread
made from chrome-steel



DIN 2181 UNI 4535

M	mm	L	L1		
6x0,75	4,5	48	16	5	004330201
7x0,75	4,5	56	18	5	004330202
8x0,75	5,0	50	16	5	004330203
8x1	5,0	56	16	5	004330204
9x0,75	6,0	63	22	5	004330205
9x1	6,0	63	22	5	004330206
10x0,75	6,5	63	18	5	004330207
10x1	6,5	63	18	5	004330208
10x1,25	6,5	63	18	5	004330209
11x0,75	7,0	70	25	3	004330210
11x1	7,0	70	25	3	004330211
11x1,25	7,0	70	25	3	004330212
12x0,75	7,0	70	20	3	004330213
12x1	7,0	70	20	3	004330214
12x1,25	7,0	70	20	3	004330215
12x1,5	7,0	70	20	3	004330216
14x1	8,0	80	32	1	004330217
14x1,25	8,0	80	32	1	004330218
14x1,5	8,0	80	32	1	004330219
16x1	10,0	80	32	1	004330220
16x1,5	10,0	80	32	1	004330221
18x1,5	11,0	95	40	1	004330222
18x2	11,0	80	25	1	004330223
20x1,5	14,5	80	22	1	004330224
22x1,5	14,5	80	22	1	004330225
24x1,5	14,5	80	22	1	004330226
24x2	14,5	80	22	1	004330227

433ASF

hand taps, **fine pitch**, UNF thread
made from chrome-steel

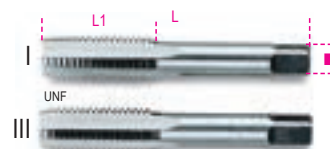

ANSI B.1.

UNF	mm	L	L1		
1/4x28	4,9	70	30	5	004330301
5/16x24	4,9	70	30	5	004330302
3/8x24	5,5	75	35	3	004330303
7/16x20	6,2	80	40	3	004330304
1/2x20	7,0	85	45	3	004330305
9/16x18	9,0	90	45	3	004330306
5/8x18	9,0	100	47	3	004330307
3/4x16	11,0	110	50	3	004330308
7/8x14	14,5	120	60	1	004330309
1"x12	16,0	130	60	1	004330310

433ASG

hand taps, cylindrical **GAS** (BSP) thread
made from chrome-steel



DIN 5157

GAS	mm	L	L1		
1/8x28	5,5	65	18	1	004330401
1/4x19	9,0	70	24	1	004330402
3/8x19	9,0	75	25	1	004330403
1/2x14	12,0	80	31	1	004330405
3/4x14	16,0	90	33	1	004330408
1"x11	20,0	100	39	1	004330410

434

hand taps, **fine pitch**, metric thread HSS

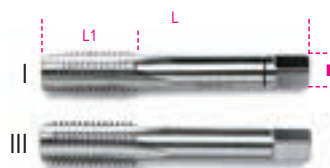

DIN 2181 UNI 4535

M	mm	L	L1		
6x0,75	4,5	48	16	5	004340001
8x0,75	5,0	56	16	5	004340003
8x1	5,0	56	16	5	004340004
10x0,75	6,5	63	18	5	004340007
10x1	6,5	63	18	5	004340008
10x1,25	6,5	63	18	5	004340009
12x1	7,0	70	20	3	004340014
12x1,25	7,0	70	20	3	004340015
12x1,5	7,0	70	20	3	004340016
13x1,5	9,0	70	20	1	004340017
14x1	9,0	70	20	1	004340018
14x1,25	9,0	70	20	1	004340019
14x1,5	9,0	70	20	1	004340020
15x1,5	9,0	70	20	1	004340021
16x1	9,0	70	20	1	004340022
16x1,5	9,0	70	20	1	004340023
18x1,5	11,0	80	22	1	004340024
18x2	11,0	90	25	1	004340025
20x1,25	12,0	80	22	1	004340026
20x1,5	12,0	80	22	1	004340027
20x2	12,0	90	25	1	004340028
22x1,5	14,5	80	22	1	004340029
24x1	14,5	80	22	1	004340030
24x1,5	14,5	80	22	1	004340031
24x2	14,5	80	22	1	004340032

435

adjustable tap wrenches, steel body



DIN 1814

	□ mm	L mm		
435/0	2÷5 M1÷M8	170	3	004350007
435/1	2÷6 M1÷M10	200	2	004350009
435/1,5	2,5÷6 M1÷M12	200	2	004350011
435/2	3÷7 M4÷M12	260	2	004350013
435/3	4÷12 M5÷M20	345	1	004350020
435/4	5,5÷16 M9÷M27	430	1	004350027
435/5	7÷18 M13÷M32	770	1	004350032

435G

adjustable tap wrenches,
light alloy body



DIN 1814

	□ mm	L mm		
435G/0	2÷5 M1÷M8	130	5	004350108
435G/1	2÷6 M1÷M10	190	5	004350110
435G/1,5	2÷7 M2÷M12	175	5	004350112
435G/2	3,4÷7 M4÷M12	280	5	004350114
435G/3	4,9÷12 M5÷M20	380	2	004350121
435G/4	7÷16 M11÷M27	500	2	004350127
435G/5	7÷18 M13÷M32	700	1	004350132
435G/6	11÷24 M18÷M42	800	1	004350142

436

reversible ratcheting tap wrenches

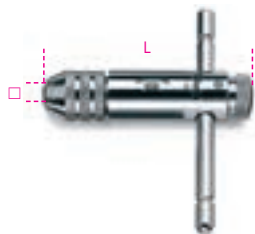

	□ mm	L mm		
436/1	2÷5 M3÷M8	85	5	004360002
436/2	4,6÷8 M5÷M12	110	5	004360004

436L

reversible ratcheting tap wrenches,
long series



	□ mm	L mm		
436L/1	2÷5 M3÷M8	245	2	004360012
436L/2	4,6÷8 M5÷M12	295	2	004360014

436R

spare clamps for items 436 and 436L

436R/1	1	004360022
436R/2	1	004360024

437C

set for repairing damaged spark plug
threads, M14x1.25 mm

• Helicoids height: 8.40 - 12.40 - 16.40 mm (5 pcs/size)



437C	1	004370100
------	---	-----------

437C/...

stainless steel helicoids for item 437C



H mm		
8.4	1	004370108
12.4	1	004370112
16.4	1	004370116

437C/RM14

male thread for spark plugs M14x1.25



437C/RM14	1	004370124
-----------	---	-----------

437K/8

tool assortment for repairing
axle shaft threads

• Allows original thread to be rectified and dressed.
Kit contents:
• Metric sizes:
20x1.25 - 20x1.5 - 22x1.00 - 22x1.5 - 24x1.5 - 24x2.00
• Inch sizes:
3/4x20 - 13/16x20



□ 32 mm

437K/8	1	004370020
--------	---	-----------

≡ 200x110x30 mm

437K/16

tool assortment for repairing
damaged threads on brake caliper brackets
M9x1.25



437K/16	1	004370016
---------	---	-----------

≡ 210x150x50 mm

437K/33

tool assortment for repairing
damaged spark plug threads

Bushes:
M8x1.0 - M10x1.0 - M10x1.25 - M12x1.25
Taps:
M8x1.0 - M10x1.0 - M10x1.25 - M12x1.0 - M12x1.25 - M14x1.25



437K/33	1	004370133
---------	---	-----------

≡ 210x150x50 mm

437U/09

assortment for repairing damaged threads
M5-M6-M8-M10-M12



437U/09	1	004370550
M5X0,8		
M6X1,0		
M8X1,25		
M10X1,5		
M12X1,75		

370x230x55 mm - 2 Kg

437U/E-M...

stainless steel helicoids



M	H mm		
M5	7.5	1	004370555
M6	9	1	004370556
M8	12	1	004370558
M10	15	1	004370560
M12	18	1	004370562

437U/PM

bits and taps for item 437U/09



M5	1	004370565
M6	1	004370566
M8	1	004370568
M10	1	004370570
M12	1	004370572

438A

set of bits for drilling, threading and countersinking, HSS

- M3 - M4 - M5 - M6 - M8 - M10
- with magnetic bit holder



438A	1	004380010
------	---	-----------

438...

bits for drilling, threading and countersinking

HSS, 1/4" drive



	S max mm		
M3	3	2	004380103
M4	4	2	004380104
M5	5	2	004380105
M6	6	2	004380106
M8	8	2	004380108
M10	10	2	004380110

440

round dies, coarse pitch,
metric thread made from chrome-steel

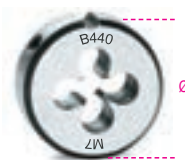

UNI EN 22568

M	Ø mm		
2x0,4	25,4	5	004400002
3x0,5	25,4	5	004400003
4x0,7	25,4	5	004400004
5x0,8	25,4	5	004400005
6x1	25,4	5	004400006
7x1	25,4	5	004400007
8x1,25	25,4	5	004400008
9x1,25	25,4	5	004400009
10x1,5	25,4	5	004400010
12x1,75	25,4	5	004400012

440A

round dies, coarse pitch,
metric thread made from chrome-steel



UNI EN 22568

M	Ø mm		
10x1,5	38,1	3	004400110
11x1,5	38,1	3	004400111
12x1,75	38,1	3	004400112
14x2	38,1	3	004400114
16x2	38,1	3	004400116
18x2,5	38,1	3	004400118
20x2,5	38,1	3	004400120

440B

round dies, coarse pitch,
metric thread made from chrome-steel



UNI EN 22568

M	Ø mm		
18x2,5	50,8	3	004400122
20x2,5	50,8	3	004400124
22x2,5	50,8	3	004400126
24x3	50,8	3	004400128

440ASW

round dies, Whitworth thread
made from chrome-steel



BSW	Ø mm		
1/8x40	25,4	5	004400201
5/32x32	25,4	5	004400202
3/16x24	25,4	5	004400203
1/4x20	25,4	5	004400204
5/16x18	25,4	5	004400205
3/8x16	38,1	3	004400206
7/16x14	38,1	3	004400207
1/2x12	38,1	3	004400208
9/16x12	38,1	3	004400209
5/8x11	50,8	3	004400210
3/4x10	50,8	3	004400211
7/8x9	50,8	3	004400212
1"x8	50,8	3	004400213

440ASC

round dies, coarse pitch,
UNC thread made from chrome-steel



UNC	Ø mm		
1/4x20	25,4	5	004400221
5/16x18	25,4	5	004400222
3/8x16	38,1	3	004400223
7/16x14	38,1	3	004400224
1/2x13	38,1	3	004400225
9/16x12	38,1	3	004400226
5/8x11	50,8	3	004400227
3/4x10	50,8	3	004400228
7/8x9	50,8	3	004400229
1"x8	50,8	3	004400230

440ASF

round dies, **fine pitch**,
UNF thread made from chrome-steel

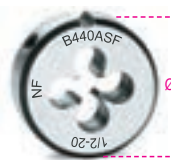

ANSI B1.1

UNF	Ø mm		
1/4x28	25,4	5	004400241
5/16x24	25,4	5	004400242
3/8x24	38,1	3	004400243
7/16x20	38,1	3	004400244
1/2x20	38,1	3	004400245
9/16x18	38,1	3	004400246
5/8x18	50,8	3	004400247
3/4x16	50,8	3	004400248
7/8x14	50,8	3	004400249
1"x12	50,8	3	004400250

440ASG

round dies, cylindrical **GAS** (BSP) thread
made from chrome-steel



UNI EN 22568

GAS	Ø mm		
1/8x28	38,1	3	004400255
1/4x19	38,1	3	004400256
3/8x19	38,1	3	004400257
1/2x14	50,8	3	004400259
3/4x14	50,8	3	004400260
1"x11	63,5	3	004400261

441

round dies, **fine pitch**, metric thread
made from chrome-steel



UNI EN 22568

M	Ø mm		
6x0,75	25,4	5	004410004
7x0,75	25,4	5	004410005
8x0,75	25,4	5	004410006
8x1	25,4	5	004410007
9x0,75	25,4	5	004410008
9x1	25,4	5	004410009

441A

round dies, **fine pitch**, metric thread
made from chrome-steel



UNI EN 22568

M	Ø mm		
10x0,75	38,1	3	004410100
10x1	38,1	3	004410101
10x1,25	38,1	3	004410102
11x0,75	38,1	3	004410103
11x1	38,1	3	004410104
11x1,25	38,1	3	004410105
12x0,75	38,1	3	004410106
12x1	38,1	3	004410107
12x1,25	38,1	3	004410108
12x1,5	38,1	3	004410109
14x1	38,1	3	004410110
14x1,25	38,1	3	004410111
14x1,5	38,1	3	004410112
16x1	38,1	3	004410113
16x1,5	38,1	3	004410114
18x1,5	38,1	3	004410115

441B

round dies, **fine pitch**, metric thread
made from chrome-steel



UNI EN 22568

M	Ø mm		
18x1,5	50,8	3	004410117
18x2	50,8	3	004410118
20x1,5	50,8	3	004410119
22x1,5	50,8	3	004410120
24x1,5	50,8	3	004410121
24x2	50,8	3	004410122

442

round dies, **coarse pitch**, metric thread HSS



UNI EN 22568

M	ØxS mm		
3x0,5	20x5	3	004420003
4x0,7	20x5	3	004420004
5x0,8	20x7	3	004420005
6x1	20x7	3	004420006
7x1	25x9	3	004420007
8x1,25	25x9	3	004420008
10x1,5	30x11	3	004420010
12x1,75	38x14	3	004420012
14x2	38x14	1	004420014
16x2	45x18	1	004420016
18x2,5	45x18	1	004420018
20x2,5	45x18	1	004420020
22x2,5	55x22	1	004420022
24x3	55x22	1	004420024

443

round dies, **fine pitch**, metric thread HSS



UNI EN 22568

M	ØxS mm		
6x0,75	20x7	1	004430107
8x0,75	25x9	1	004430110
8x1	25x9	1	004430111
10x0,75	30x11	1	004430113
10x1	30x11	1	004430114
10x1,25	30x11	1	004430115
12x1	38x10	1	004430116
12x1,25	38x10	1	004430117
12x1,5	38x10	1	004430118
13x1,5	38x10	1	004430119
14x1	38x10	1	004430120
14x1,25	38x10	1	004430121
14x1,5	38x10	1	004430122
15x1,5	38x10	1	004430123
16x1	45x14	1	004430124
16x1,5	45x14	1	004430125
18x1,5	45x14	1	004430127
20x1,25	45x14	1	004430129
20x1,5	45x14	1	004430130
20x2	45x14	1	004430131
22x1,5	55x16	1	004430132
24x1	55x16	1	004430133
24x1,5	55x16	1	004430135
24x2	55x16	1	004430136

444

die stocks, steel body



DIN 225

444	Ø mm	L mm		
444	20x5	215	5	004440005
444/0	20x7	215	5	004440007
444/1	25,4	225	5	004440025
444/1A	25x9	225	5	004440027
444/1B	30x11	300	5	004440030
444/C	38x10	315	3	004440033
444/1C	38x14	315	3	004440035
444/2	38,1x12,7	360	3	004440038
444/1D	45x14	455	1	004440045
444/2D	45x18	455	1	004440046
444/3	50,8x15,9	555	1	004440050
444/4	55x16	555	1	004440055
444/5A	63,5x19,7	630	1	004440057

444G

die stocks, light alloy body



UNI EN 22568

444G/A	Ø mm	L mm		
444G/A	16x5	160	5	004440103
444G	20x5	200	5	004440105
444G/0	20x7	200	5	004440107
444G/1	25,4	210	5	004440125
444G/1A	25x9	224	5	004440127
444G/1B	30x11	280	5	004440130
444G/C	38x10	315	3	004440133
444G/1C	38x14	315	3	004440135
444G/2	38,1x12,6	320	3	004440138
444G/1D	45x14	450	1	004440145
444G/2D	45x18	450	1	004440146
444G/3	50,8x16	500	1	004440150
444G/4	55x16	560	1	004440155
444G/5A	63,5x19	620	1	004440163
444G/6	65x18	630	1	004440165

446/C30

assortment of chrome-steel taps and dies, metric thread, and accessories in wooden case



446/C30 1 004460055

325x220x35 mm - 3,2 Kg

430 M mm	440 M mm		
3x0,5	3x0,5	435/1,5	444/1
4x0,7	4x0,7		
5x0,8	5x0,8		
6x1	6x1		
8x1,25	8x1,25		
10x1,5	10x1,5		
12x1,75	12x1,75		

446/C48

assortment of chrome-steel taps and dies, metric thread, and accessories in wooden case



446/C48 1 004460057

580x300x50 mm - 5 Kg

430 M mm	440 M mm	440A M mm		
3x0,5	3x0,5	10x1,5	435/1	444/1
4x0,7	4x0,7	12x1,75	435/3	444/2
5x0,8	5x0,8	14x2		
6x1	6x1	16x2		
8x1,25	8x1,25	18x2,5		
10x1,5		20x2,5		
12x1,75				
14x2				
16x2				
18x2,5				
20x2,5				

446/C110

assortment of chrome-steel taps and dies, metric thread, and accessories for car repair jobs in wooden case



446/C110 1 004460060

500x337x60 mm - 8,1 Kg

430 M mm	433 M mm	440/440A, 441/441A M mm	441A M mm
2x0,4	6x0,75	2x0,4	6x0,75
3x0,5	7x0,75	3x0,5	7x0,75
4x0,7	8x0,75	4x0,7	8x0,75
5x0,8	8x1	5x0,8	8x1
6x1	9x0,75	6x1	9x0,75
7x1	9x1	7x1	9x1
8x1,25	10x0,75	8x1,25	10x0,75
9x1,25	10x1	9x1,25	10x1
10x1,5	10x1,25	10x1,5	10x1,25
11x1,5	11x0,75	11x1,5	11x0,75
12x1,75	11x1	12x1,75	11x1
14x2	11x1,25	14x2	11x1,25
16x2	12x0,75	16x2	12x0,75
	12x1		12x1
	12x1,25		12x1,25
	12x1,5		12x1,5
	14x1		14x1
	14x1,25		14x1,25
	14x1,5		14x1,5
	16x1		16x1
	16x1,5		16x1,5
	18x1,5		18x1,5

435/0	444/1	436/1
435/3	444/2	

446ASF/C29

assortment of chrome-steel taps and dies, UNF thread, and accessories in wooden case



446ASF/C29 1 004460070

660x410x50 mm - 6 Kg

433ASF	440ASF		
1/4	1/4	435/1,5	444/1
5/16	5/16	435/3	444/2
3/8	3/8		444/3
7/16	7/16		
1/2	1/2		
9/16	9/16		
5/8	5/8		
3/4	3/4		

446ASW/C36

assortment of chrome-steel taps and dies, Whitworth thread, and accessories in wooden case



446ASW/C36 1 004460075

525x310x50 mm - 3,4 Kg

430ASW	440ASW		
1/8	1/8	435/1,5	444/1
5/32	5/32	435/2	444/2
3/16	3/16		
1/4	1/4		
5/16	5/16		
3/8	3/8		
7/16	7/16		
1/2	1/2		

446ASC/C37

assortment of chrome-steel taps and dies, **UNC** thread, and accessories in wooden case



446ASC/C37 1 004460080

≡ 660x410x50 mm - 6,7 Kg

430ASC	440ASC		
1/4	1/4	435/1,5	444/1
5/16	5/16	435/3	444/2
3/8	3/8		444/3
7/16	7/16		
1/2	1/2		
9/16	9/16		
5/8	5/8		
3/4	3/4		

446ASG/C23

assortment of chrome-steel taps and dies, cylindrical **GAS** thread, and accessories in wooden case



446ASG/C23 1 004460085

≡ 700x430x70 mm - 9,8 Kg

433ASG	440ASG		
1/8	1/8	435/3	444/2
1/4	1/4	435/5	444/3
3/8	3/8		444/5A
1/2	1/2		
3/4	3/4		
1"	1"		

447/C37

assortment of HSS taps and dies, metric thread, and accessories in metal case



447/C37 1 004470055

≡ 380x185x35 mm - 3,9 Kg

431 M	442 M		
3x0,5	3x0,5	435/0	444
4x0,7	4x0,7	435/2	444/0
5x0,8	5x0,8		444/1A
6x1	6x1		444/1B
8x1,25	8x1,25		444/1C
10x1,5	10x1,5		
12x1,75	12x1,75		

436/1	0,5x3x75
-------	----------

447/C53

assortment of HSS taps and dies, metric thread, and accessories in metal case



447/C53 1 004470060

≡ 500x235x50 mm - 9 Kg

431 M	442 M			
3x0,5	3x0,5	435/1,5	444	436/1
4x0,7	4x0,7	435/3	444/0	436/2
5x0,8	5x0,8		444/1A	
6x1	6x1		444/1B	
8x1,25	8x1,25		444/1C	
10x1,5	10x1,5		444/2D	
12x1,75	12x1,75			
14x2	14x2			
16x2	16x2			
18x2,5	18x2,5			
20x2,5	20x2,5			

447/C70

assortment of HSS taps and dies, metric thread, and accessories for car repair jobs industrial maintenance in wooden case



447/C70 1 004470065

≡ 510x340x70 mm - 7,5 Kg

431 M	434 M	442 M	443 M
3x0,5	8x1	3x0,5	8x1
4x0,7	10x1,25	4x0,7	10x1,25
5x0,8	12x1,25	5x0,8	12x1,25
6x1	12x1,5	6x1	12x1,5
7x1	14x1,25	7x1	14x1,25
8x1,25	14x1,5	8x1,25	14x1,5
10x1,5	16x1,5	10x1,5	16x1,5
12x1,75		12x1,75	
14x2		14x2	
16x2		16x2	

435/0	444	436/1
435/3	444/0	
	444/1A	
	444/1B	
	444/1C	
	444/1D	

450

holesaws HSS, Bimetal



HSS-Co 8%

Ø mm	Ø "	A mm	
16	(5/8)	57	1 004500016
17	(11/16)	57	1 004500017
19	(3/4)	51	1 004500019
20	-	51	1 004500020
21	(13/16)	51	1 004500021
22	(7/8)	51	1 004500022
24	(15/16)	51	1 004500024
25	(1")	51	1 004500025
27	(1 1/16)	51	1 004500027
29	(1 1/8)	51	1 004500029
30	(1 3/16)	51	1 004500030
32	(1 1/4)	51	1 004500032
33	(1 5/16)	51	1 004500033
35	(1 3/8)	51	1 004500035
37	(1 7/16)	51	1 004500037
38	(1 1/2)	44	1 004500038

Ø mm	Ø "	A mm		
40	(1"9/16)	44	1	004500040
41	(1"5/8)	44	1	004500041
43	(1"11/16)	44	1	004500043
44	(1"3/4)	44	1	004500044
46	(1"13/16)	44	1	004500046
48	(1"7/8)	44	1	004500048
51	(2")	44	1	004500051
52	(2"1/16)	44	1	004500052
54	(2"1/8)	44	1	004500054
57	(2"1/4)	44	1	004500057
59	(2"5/16)	44	1	004500059
60	(2"3/8)	44	1	004500060
64	(2"1/2)	44	1	004500064
65	(2"9/16)	44	1	004500065
67	(2"5/8)	44	1	004500067
68	-	44	1	004500068
70	(2"3/4)	44	1	004500070
73	(2"7/8)	44	1	004500073
76	(3")	44	1	004500076
79	(3"1/8)	44	1	004500079
83	(3"1/4)	44	1	004500083
86	(3"3/8)	44	1	004500086
89	(3"1/2)	44	1	004500089
92	(3"5/8)	44	1	004500092
95	(3"3/4)	44	1	004500095
98	(3"7/8)	44	1	004500098
102	(4")	44	1	004500102
105	(4"1/8)	44	1	004500105
108	(4"1/4)	44	1	004500108
111	(4"3/8)	44	1	004500111
114	(4"1/2)	44	1	004500114
121	(4"3/4)	44	1	004500121
127	(5")	44	1	004500127
140	(5"1/2)	44	1	004500140
152	(6")	44	1	004500152

450AL

arbors for holesaws

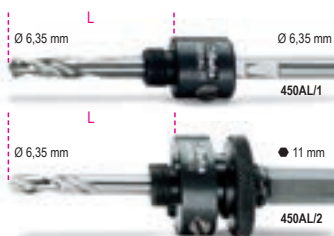

	Ø mm	L mm		
450AL/1	16÷30	54	1	004500210
450AL/2	32÷152	70	1	004500215

450AD

adaptors for arbors item 450AL/1



	Ø mm			
450AD	32÷51	1	004500230	

450PA/1

pilot drills for arbors item 450AL/1, HSS



ØxL mm			
6,35x105	1	004500252	

450PA/2

pilot drills for arbors item 450AL/2, HSS



ØxL mm			
6,35x80	1	004500253	

450PR

extension for holesaws



L mm			
305	1	004500255	

450/C9

assortment of holesaws and accessories for electricians



HSS-Co 8%

450/C9	1	004500305	

450	Ø 22 - 29 - 35 - 44 - 51 - 64 mm
450AL	/1 - /2
450AD	
	220x160x60 mm - 1,6 Kg

450/C13

assortment of holesaws and accessories for installers



HSS-Co 8%

450/C13	1	004500310	

450	Ø 19 - 22 - 29 - 35 - 38 44 - 51 - 57 - 64 mm
450AL	/1 - /2
450PA/1	
450AD	
	215x180x65 mm - 1,8 Kg

450/C15

assortment of holesaws and accessories for electricians



450/C15	1	004500313	

450	Ø 16 - 20 - 25 - 32 - 40 51 - 60 - 65 - 70 mm
450AL	/1 - /2
450PA	/1 - /2
450PR	
450AD	
	420x185x60 mm - 3,2 Kg

 Beta

 Beta

450/C21

assortment of holesaws and accessories
for industrial use



HSS-Co 8%

450/C21

1 004500315

450 Ø 19 - 22 - 29 - 35 - 38
44 - 51 - 57 - 64 - 76
83 - 92 - 95 - 105 - 114 mm

450AL /1 - /2

450PA /1 - /2

450PR

450AD

420x280x60 mm - 7 Kg

451

hole cutters HSS, entirely ground

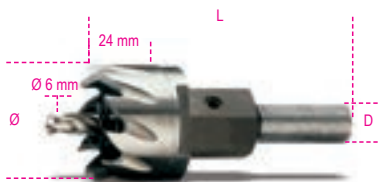

Ø mm	L mm	D mm	
12	85	8	1 004510012
13	85	8	1 004510013
14	85	8	1 004510014
15	85	10	1 004510015
16	85	10	1 004510016
17	85	10	1 004510017
18	85	10	1 004510018
19	85	10	1 004510019
20	85	10	1 004510020
21	85	10	1 004510021
22	85	10	1 004510022
23	85	10	1 004510023
24	85	10	1 004510024
25	85	10	1 004510025
26	90	10	1 004510026
27	90	10	1 004510027
28	90	10	1 004510028
29	90	10	1 004510029
30	90	10	1 004510030
31	90	10	1 004510031
32	90	10	1 004510032
33	90	10	1 004510033
34	90	10	1 004510034
35	90	10	1 004510035
36	85	10	1 004510036
37	85	10	1 004510037
38	85	10	1 004510038
39	85	10	1 004510039
40	85	10	1 004510040
41	85	10	1 004510041
42	85	10	1 004510042
43	85	10	1 004510043
44	85	10	1 004510044
45	85	10	1 004510045
46	85	10	1 004510046
47	85	10	1 004510047
48	85	10	1 004510048
49	85	10	1 004510049
50	85	10	1 004510050

451GA

arbors for hole cutters item 451



M	Ø mm	L mm	D mm	
10x1,25	12÷14	57	8	1 004510101
12x1,25	15÷34	57	10	1 004510102
14x1,5	35÷50	57	10	1 004510105

451PA

pilot drill for hole cutters item 451
HSS



Ø mm	L mm	
6	53	1 004510103

451PR

extension for hole cutters item 451



M	Ø mm	L mm	Ø1 mm	
12x1,25	15÷34	400	13	1 004510104
14x1,5	35÷50	400	13	1 004510108

452

hole cutters with hard metal insets

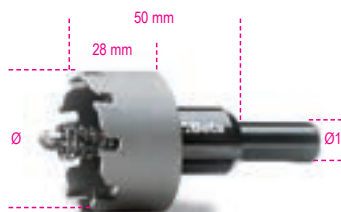

Ø mm	Ø1 mm	
15	10	1 004520015
16	10	1 004520016
17	10	1 004520017
18	10	1 004520018
19	10	1 004520019
20	10	1 004520020
21	10	1 004520021
22	10	1 004520022
23	10	1 004520023
24	10	1 004520024
25	10	1 004520025
26	10	1 004520026
27	10	1 004520027
28	10	1 004520028
29	10	1 004520029
30	10	1 004520030
31	10	1 004520031
32	10	1 004520032
33	10	1 004520033
34	10	1 004520034
35	10	1 004520035
36	10	1 004520036
37	10	1 004520037
38	10	1 004520038
39	13	1 004520039
40	13	1 004520040

Ø mm	Ø1 mm	
41	13	1 004520041
42	13	1 004520042
43	13	1 004520043
44	13	1 004520044
45	13	1 004520045
46	13	1 004520046
47	13	1 004520047
48	13	1 004520048
49	13	1 004520049
50	13	1 004520050
55	13	1 004520055
60	13	1 004520060
65	13	1 004520065
70	13	1 004520070
75	13	1 004520075
80	13	1 004520080
85	13	1 004520085
90	13	1 004520090

452GA

arbors for hole cutters item 452



	Ø mm	
452GA/1	15÷21	1 004520125
452GA/2	22÷38	1 004520126
452GA/3	39÷100	1 004520127



560/C2

torque multiplier, ratio 5:1,
and accessories in plastic case

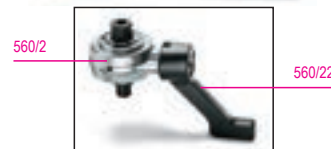

Nm	Kgfm	lbf.ft	□	■	kg
1300	130	960	1/2	3/4	3,8

560/C2		1 005600020
560/2		1 005600002
560/18		1 005600018
560/19		1 005600019
560/22		1 005600022

310x275x120 mm

560/C4+

Torque multiplier,
ratio 5:1,
with reaction foot



560/18

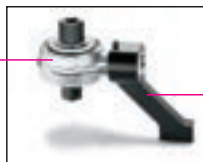

560/4

560/22



Nm	Kgfm	lbf.ft	□	■	kg
2700	270	2000	3/4	1"	5

560/C4PLUS	1	005600042
560/4	1	005600004
560/18	1	005600018
560/22	1	005600022

310x275x120 mm

560/C6

torque multipliers for right-hand and left-hand
tightening in plastic case
ratio: 6.5:1



Nm	Kgfm	lbf.ft	□	■	kg
1500	150	1106	1/2"	3/4"	6

560/C6	1	005600160
--------	---	-----------

400x260x110 mm

560/C12

torque multipliers for right-hand and left-hand
tightening in plastic case
ratio: 12:1



Nm	Kgfm	lbf.ft	□	■	kg
2500	250	1844	1/2"	1"	7

560/C12	1	005600210
---------	---	-----------

400x260x110 mm

561/1

torque multiplier,
ratio 5:1
with two reaction feet

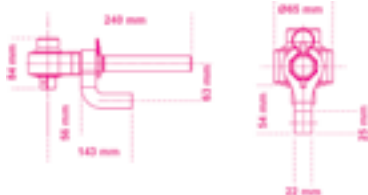

Nm	Kgfm	lbf.ft	□	■	kg
1000	100	740	1/2	3/4	2,7

561/1	1	005610010
-------	---	-----------

270x210x70 mm

562/1 - 562/2

torque multipliers, ratio 5:1

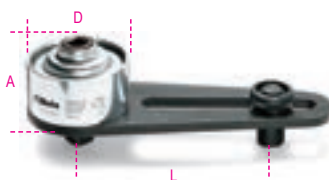

Nm	Kgfm	lbf.ft	□	■	D	A	L min	L max	kg
					mm	mm	mm	mm	
1700	170	1250	3/4	1"	108	95	85	220	5,3

562/1	1	005620001
-------	---	-----------

Nm	Kgfm	lbf.ft	□	■	D	A	L min	L max	kg
					mm	mm	mm	mm	
3400	340	2500	3/4	1"	119	115	85	265	7,0

562/2	1	005620002
-------	---	-----------

564/3R - 564/4R

torque multipliers, ratio 25:1,
with anti-wind up system



Nm	Kgfm	lbf.ft	□	■	D	A	L	kg
					mm	mm	mm	
3000	300	2200	1/2	1"	108	188	155	9,2

564/3R	1	005640003
--------	---	-----------

Nm	Kgfm	lbf.ft	□	■	D	A	L	kg
					mm	mm	mm	
6000	600	4500	1/2	1 1/2	119	235	200	15,5

564/4R	1	005640004
--------	---	-----------

565/1R - 565/2R - 565/3R

torque multipliers, ratio 25:1
with anti-wind up system



Nm	Kgfm	lbf.ft	□	■	D	A	L min	L max	kg
					mm	mm	mm	mm	
1700	170	1250	1/2	1"	108	125	80	215	7,7

565/1R	1	005650011
--------	---	-----------

Nm	Kgfm	lbf.ft	□	■	D	A	L min	L max	kg
					mm	mm	mm	mm	
3400	340	2500	1/2	1"	119	145	85	265	10,1

565/2R	1	005650012
--------	---	-----------

Nm	Kgfm	lbf.ft	□	■	D	A	L min	L max	kg
					mm	mm	mm	mm	
3400	340	2500	1/2	1 1/2	119	145	85	265	10,7

565/3R	1	005650013
--------	---	-----------

 Beta

 Beta

565/4R

torque multiplier, ratio 25:1
with anti-wind up system

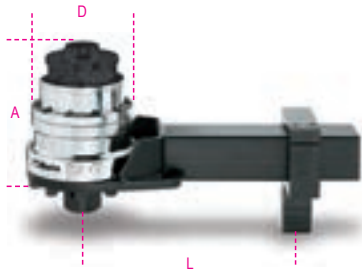

Nm	Kgfm	lbf.ft	□	■	D	A	L min	L max	⚖
6000	600	4500	1/2	1"1/2	144	180	125	335	17

565/4R 1 005650014

565/5R

torque multiplier, ratio 25:1
with anti-wind up system

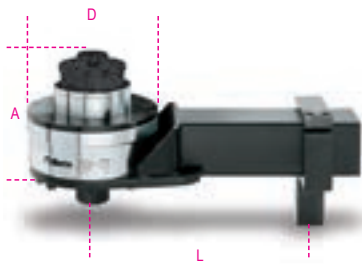

Nm	Kgfm	lbf.ft	□	■	D	A	L min	L max	⚖
9500	950	7000	3/4	1"1/2	184	180	155	355	25

565/5R 1 005650015

567/4R

torque multiplier, ratio 125:1
with anti-wind up system

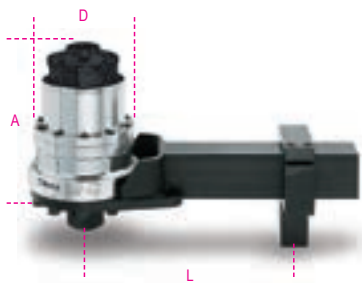

Nm	Kgfm	lbf.ft	□	■	D	A	L min	L max	⚖
6000	600	4500	1/2	1"1/2	144	210	125	335	19

567/4R 1 005670014

567/5R

torque multiplier, ratio 125:1
with anti-wind up system

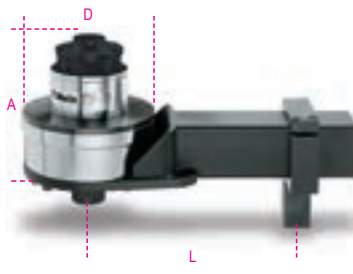

Nm	Kgfm	lbf.ft	□	■	D	A	L min	L max	⚖
9500	950	7000	1/2	1"1/2	184	210	155	350	27

567/5R 1 005670015

581

slip-torque screwdriver, ungraduated
for right-hand tightening
torque accuracy: ±6%
(to be used with items 588 - 682)



UNI EN ISO 6789

Nm	gfm	□	⚖
1,2÷6	120÷600	1/4"	275

581 1 005810001

583

slip-torque screwdriver, graduated
for right-hand tightening
torque accuracy: ±6%



UNI EN ISO 6789

Nm	gfm	□	⚖
0,3÷1,5	30÷150	1/4"	240

583/1,5 1 005830015

Nm	gfm	□	⚖
0,6÷3	60÷300	1/4"	240

583/3 1 005830030

Nm	gfm	□	⚖
1,2÷6	120÷600	1/4"	350

583/6 1 005830060

583/C31

1 torque screwdriver, 8 hexagon hand sockets,
20 bits and 2 accessories

1/4



583/C31 1 005830931

	583/6	1.2 - 6 Nm
	900	4-5-5,5-6-7-8-9-10 mm
	860LP	0,6x4,5 - 1x5,5 - 1,2x6,5 mm
	860PH	PH1 - PH2 (x2) - PH3
	860PE	2-2,5-3-4-5 mm
	860TX	T9-T10-T15-T20-T25-T27-T30-T40
	882P/80	80 mm
	892/0	● 1/4 ■ 1/4

270x120x45 mm - 1,2 kg

588

electronic digital torque meter

For testing and setting torque screwdrivers 581-583
Reading accuracy: ± 1% of read value

CE



Nm	lbf.in	□	⚖
1÷10	10÷90	1/4"	1,8

588 1 005880001

590 - 592

direct reading torque wrenches
for right-hand and left-hand tightening
torque accuracy: ±4%



UNI EN ISO 6789

Nm	Kgfm	lbf.in	□	A	L	⚖
0,3÷4	0,03÷0,4	3÷35	1/4	60	253	0,52

590 1 005900001

Nm	Kgfm	lbf.in	□	A	L	⚖
0,5÷13,5	0,05÷1,35	4÷120	1/4	60	253	0,52

590/1 1 005900003

Nm	Kgfm	lbf.in	■	A	L	kg
1÷27	0,1÷2,7	10÷240	3/8	70	253	0,52

592/3 1 005920005

Nm	Kgfm	lbf.in	■	A	L	kg
3÷40	0,3÷4	20÷360	3/8	70	253	0,52

592/4 1 005920007

Table of fields of use
for torque wrenches and bars
at end of price list

594

direct reading torque wrenches
for right-hand and left-hand tightening
torque accuracy: $\pm 4\%$

12"

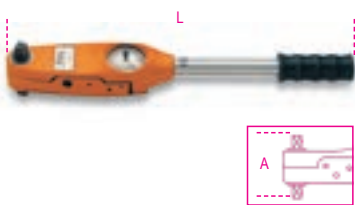

UNI EN ISO 6789

Nm	Kgfm	lbf.ft	■	A	L	kg
6÷80	0,6÷8	5÷60	1/2	85	455	1,35

594/8 1 005940011

Nm	Kgfm	lbf.ft	■	A	L	kg
20÷215	2÷21,5	15÷160	1/2	85	530	1,40

594/21 1 005940015

596 - 598

direct reading torque wrenches
for right-hand and left-hand tightening
torque accuracy: $\pm 4\%$

A signal light and an intermittent sound mean the pre-set
torque load is achieved.



UNI EN ISO 6789

Nm	Kgfm	lbf.ft	■	A	L	kg
80÷400	8÷40	60÷300	3/4	111	710	3,2

596/40SL 1 005960010

Nm	Kgfm	lbf.ft	■	A	L	kg
160÷800	16÷80	120÷600	3/4"	115	1025	4,85

596/80SL 1 005960020

Nm	Kgfm	lbf.ft	■	A	L	kg
200÷2000	20÷200	150÷1500	1"	135	1930	16,70

598/200SL 1 005980022

Torque calibration
service
at end of price list

599DGT

electronic torque wrench
with reversible ratchet,
right-hand (accuracy: $\pm 2\%$) and left-hand
(accuracy: $\pm 3\%$) tightening

- Dual measurement mode: peak hold and track
- Light indicators and an intermittent sound inform user that preset torque has been reached
- Power supply: 2 1.5V batteries (included)



UNI EN ISO 6789

Nm	Kgfm	lbf.ft	■	D	A	L	kg
12÷60	1,2÷6	8÷44	3/8	30	33	413	0,9

599DGT/6 1 005990003

Nm	Kgfm	lbf.ft	■	D	A	L	kg
20÷100	2÷10	15÷80	1/2	30	37	413	0,9

599DGT/10X 1 005990010

Nm	Kgfm	lbf.ft	■	D	A	L	kg
40÷200	4÷20	30÷150	1/2	40	43	520	2

599DGT/20 1 005990020

Nm	Kgfm	lbf.ft	■	D	A	L	kg
68÷340	6,8÷34	58÷280	1/2	40	43	640	2,35

599DGT/30 1 005990030

599DGT-AN

electronic torque wrench, torque and angle
readout,
with reversible ratchet,
right-hand (accuracy: $\pm 2\%$)
and left-hand (accuracy: $\pm 3\%$) tightening

- tightening types: torque, angle, torque + angle
- dual measurement mode: peak hold and track
- light indicators and an intermittent sound inform user that preset torque or angle has been reached
- tightening data storage (up to 250 values)
- up to 9 torque/angle values can be preset
- key safety lockout
- wrench can be associated with 16 users through user ID
- tightening data traceability. Software allows date and time, tool serial number, set tightening value and reached value to be stored and associated with user ID
- nonslip bi-material handle
- included: 2 AA - 1.5V batteries, USB cable and software



UNI EN 26789
ISO 6789

Nm	Kgfm	lbf.ft	■	D	A	L	kg
20÷100	2÷10	15÷80	1/2	30	33	413	0,9

599DGT-AN/10 1 005990610

Nm	Kgfm	lbf.ft	■	D	A	L	kg
40÷200	4÷20	30÷150	1/2	40	43	520	1,3

599DGT-AN/20 1 005990620

Torque calibration
service
at end of price list

Beta

600

torque angle indicators

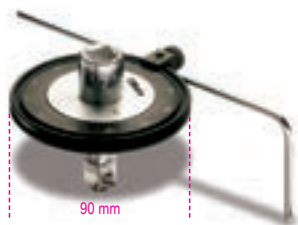

	□	■	
600/1	1/2	1/2	1 006000001
600/2	3/4	3/4	1 006000002

601C

digital tangle indicator

Light signals and an intermittent sound inform user that preset angle has been reached

CE



601C	1 006010100
------	-------------

85x80x87 mm - 70 g

601CA

digital torque and angle indicator

light indicators and an intermittent sound inform user that preset torque or angle has been reached

12"

CE



	□	■	Nm	
601CA	1/2"	1/2"	10÷200	1 006010120

120x90x120 mm - 240 g

603

calibrated slipping torque wrenches for right-hand tightening torque accuracy: ±6%

14"



UNI EN ISO 6789

Nm	Kgfm	lbf.in	■	A mm	L mm	g
1÷5	0,1÷0,5	10÷45	1/4	35	195	235

603/5	1 006030005
-------	-------------

Nm	Kgfm	lbf.in	■	A mm	L mm	g
2÷10	0,2÷1,0	18÷90	1/4	35	195	235

603/10	1 006030010
--------	-------------

604B

break-back torque bars for right-hand and left-hand tightening torque accuracy: ± 6%



UNI EN ISO 6789

Nm	kgfm	lbf.in	Ø mm	L mm	g
1÷5	0,1÷0,5	10÷45	8	220	290

604B/5	1 006040015
--------	-------------

Nm	Kgfm	lbf.in	Ø mm	L mm	g
2÷10	0,2÷1,0	18÷90	8	220	300

604B/10	1 006040020
---------	-------------

605E

click-type torque wrenches with reversible ratchets for right-hand and left-hand tightening torque accuracy: ± 6%

14"



UNI EN ISO 6789

Nm	Kgfm	lbf.in	■	A mm	L mm	g
1÷5	0,1÷0,5	10÷45	1/4	20	190	180

605E/5	1 006050105
--------	-------------

Nm	Kgfm	lbf.in	■	A mm	L mm	g
2÷10	0,2÷1,0	18÷90	1/4	20	190	180

605E/10	1 006050110
---------	-------------

611

reversible ratchets for torque bars items 604B/5 and 604B/10 8 mm drive



■	L mm	
1/4	42,5	1 006110001

Torque calibration service at end of price list

612 ÷ 614

reversible ratchets for torque bars



Items 612 and 612X should not be used with tightening torques exceeding 100 Nm

	■	L mm	LA mm	
612	3/8	66	32	2 006120000
612X	1/2	66	32	2 006120010
614	1/2	71	32	2 006140000
614X	3/4	71	32	2 006140004

614/50

push-through ratchet for torque bars



	■	L mm	LA mm	
614/50	1/2	71	32	2 006140002

Spare parts rotating mechanism of ratchets, see table after item 929/C8

Beta

615

reversible ratchets
for torque bars, rectangular drive



mm	mm	L mm	LA mm		
9x12	3/8	53	28,8	1	006150010
9x12	1/2	53	28,8	1	006150020
14x18	1/2	70	39,8	1	006150120

616 - 617 - 619

fixed heads for torque bars



	mm	L mm	LA mm		
616	1/4	61	32	1	006160000
617	3/8	61	32	1	006170000
619	1/2	63	32	1	006190000

621

bit holder accessories
for torque bars, rectangular drive



	mm	mm	L mm	LA mm		
P 1/4	9x12	1/4	40	28,8	1	006210000
* P 5/16	14x18	5/16	61	32,5	1	006210110

*Caution! Recalculate torque value to set as shown in table at end of price list

641

open jaw wrenches
for torque bars 604B/5 and 604B/10
8 mm drive



mm	L mm		
4	37	1	006410003
5	37	1	006410004
5,5	37	1	006410005
6	37	1	006410006
7	37	1	006410007
8	42	1	006410008
9	42	1	006410009
10	42	1	006410010

Beta

642

open jaw wrenches for torque bars



mm	L mm	LA mm	A mm		
8	54	32	22	1	006420008
10	57	32	26	1	006420010
12	58	32	30	1	006420012
13	58	32	30	1	006420013
14	59	32	32	1	006420014
15	59	32	35	1	006420015
16	59	32	38	1	006420016
17	60	32	39	1	006420017
18	61	32	42	1	006420018
19	61	32	43	1	006420019
20	61	32	50	1	006420020
21	62	32	53	1	006420021
22	62	32	53	1	006420022
23	65	32	53	1	006420023
24	63	32	53	1	006420024
26	64	32	59	1	006420026
27	65	32	59	1	006420027
28	66	32	64	1	006420028
30	66	32	66	1	006420030
32	67	32	66	1	006420032
* 36	76	42	80	1	006420036
* 40	77	52	95	1	006420040
* 41	78	52	95	1	006420041
* 46	90	52	95	1	006420046

*Caution! Recalculate torque value to set as shown in table at end of price list

643

open jaw wrenches
for torque bars, rectangular drive

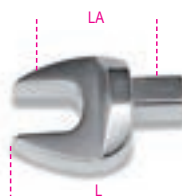

mm	mm	L mm	LA mm		
8	9x12	37	28,8	1	006430008
10	9x12	39	28,8	1	006430010
12	9x12	39	28,8	1	006430012
13	9x12	39	28,8	1	006430013
14	9x12	43	28,8	1	006430014
15	9x12	43	28,8	1	006430015
16	9x12	43	28,8	1	006430016
17	9x12	43	28,8	1	006430017
* 18	9x12	47	36,3	1	006430018
* 19	9x12	51	36,3	1	006430019
* 22	9x12	52	36,3	1	006430022

*Caution! Recalculate torque value to set as shown in table at end of price list

mm	mm	L mm	LA mm		
13	14x18	60	39,8	1	006430113
14	14x18	58	39,8	1	006430114
15	14x18	60	39,8	1	006430115
16	14x18	60	39,8	1	006430116
17	14x18	60	39,8	1	006430117
18	14x18	61	39,8	1	006430118
19	14x18	61	39,8	1	006430119
21	14x18	61	39,8	1	006430121
22	14x18	62	39,8	1	006430122
24	14x18	64	39,8	1	006430124
* 27	14x18	68	44,8	1	006430127
* 30	14x18	77	49,8	1	006430130
* 32	14x18	77	49,8	1	006430132
* 34	14x18	80	54,8	1	006430134
* 36	14x18	83	54,8	1	006430136
* 41	14x18	91	64,8	1	006430141

*Caution! Recalculate torque value to set as shown in table at end of price list

652

ring wrenches for torque bars



mm	L mm	LA mm		
8	58	32	1	006520008
10	58	32	1	006520010
12	58	32	1	006520012
13	58	32	1	006520013
14	58	32	1	006520014
15	62	32	1	006520015
16	63	32	1	006520016
17	64	32	1	006520017
18	65	32	1	006520018
19	65	32	1	006520019
21	67	32	1	006520021
22	68	32	1	006520022
24	69	32	1	006520024
26	71	32	1	006520026
27	71	32	1	006520027
30	73	32	1	006520030
32	74	32	1	006520032

*Caution! Recalculate torque value to set as shown in table at end of price list

653

ring wrenches
for torque bars, rectangular drive



mm	mm	L mm	LA mm		
8	9x12	40	28,8	1	006530008
10	9x12	43	28,8	1	006530010
12	9x12	44	28,8	1	006530012
13	9x12	44	28,8	1	006530013
14	9x12	45	28,8	1	006530014
15	9x12	46	28,8	1	006530015
16	9x12	47	28,8	1	006530016
17	9x12	47	28,8	1	006530017
18	9x12	48	28,8	1	006530018
19	9x12	49	28,8	1	006530019
22	9x12	51	28,8	1	006530022

*Caution! Recalculate torque value to set as shown in table at end of price list

mm	mm	L mm	LA mm		
13	14x18	61	39,8	1	006530113
14	14x18	61	39,8	1	006530114
15	14x18	62	39,8	1	006530115
16	14x18	63	39,8	1	006530116
17	14x18	64	39,8	1	006530117
18	14x18	64	39,8	1	006530118
19	14x18	66	39,8	1	006530119
21	14x18	66	39,8	1	006530121
22	14x18	67	39,8	1	006530122
24	14x18	69	39,8	1	006530124
*27	14x18	76	44,8	1	006530127
*30	14x18	77	44,8	1	006530130
*32	14x18	79	44,8	1	006530132
*34	14x18	80	44,8	1	006530134
*36	14x18	80	44,8	1	006530136
*41	14x18	90	49,8	1	006530141

*Caution! Recalculate torque value to set as shown in table at end of price list

659/15

adaptor with rectangular female (14x18 mm) and male (9x12 mm) drives



L mm	mm	mm		
*56	14x18	9x12	1	006590815

*Caution! Recalculate torque value to set as shown in table at end of price list

659/16

adaptor with rectangular female (9x12 mm) and male (14x18 mm) drives



L mm	mm	mm		
*52	9x12	14x18	1	006590816

*Caution! Recalculate torque value to set as shown in table at end of price list

665

mechanical torque wrench with digital setting and reversible ratchet, for right-hand tightening, torque accuracy $\pm 3\%$

- Auto power off after 10" when torque is set under minimum torque threshold
- Display will remain on with set torque value
- Torque setting to decimal digit
- Power supply: battery 1 3V (included)



UNI EN ISO 6789

Nm	mm	D mm	A mm	L mm	g
10÷60	3/8	30	33	335	655

665/6	1	006650006
-------	---	-----------

Nm	mm	D mm	A mm	L mm	g
20÷100	3/8	30	33	375	725

665/10	1	006650010
--------	---	-----------

Nm	mm	D mm	A mm	L mm	g
20÷100	1/2	30	37	375	725

665/10X	1	006650011
---------	---	-----------

Nm	mm	D mm	A mm	L mm	g
40÷200	1/2	40	43	470	995

665/20	1	006650020
--------	---	-----------

Nm	mm	D mm	A mm	L mm	g
60÷330	1/2	40	43	590	1260

665/30	1	006650030
--------	---	-----------

665LB

mechanical torque wrench, digital readout, with reversible ratchet, for right-hand tightening, torque accuracy: $\pm 3\%$

- Unit of measurement: lbf.ft
- Torque is easy to set and read through value shown on display
- Display remains on with set torque value
- Torque reading to 0.1 mm
- Automatic switch-off after 30 sec. with torque setting under minimum threshold
- Power supply: 1 3V battery (included)

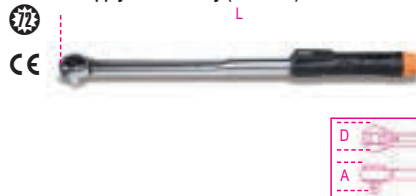

UNI EN ISO 6789

lbf.ft	mm	D mm	A mm	L mm	g
7÷45	3/8	30	33	335	655

665LB/6	1	006650106
---------	---	-----------

lbf.ft	mm	D mm	A mm	L mm	g
15÷75	3/8	30	33	375	725

665LB/10	1	006650110
----------	---	-----------

lbf.ft	mm	D mm	A mm	L mm	g
15÷75	1/2	30	37	375	725

665LB/10X	1	006650111
-----------	---	-----------

lbf.ft	mm	D mm	A mm	L mm	g
30÷150	1/2	40	43	470	995

665LB/20	1	006650120
----------	---	-----------

lbf.ft	mm	D mm	A mm	L mm	g
45÷240	1/2	40	43	590	1260

665LB/30	1	006650130
----------	---	-----------

665SW

calibration device

- Device allows calibration of wrenches item 665 with help of torque meters 680 and 682, without having to dismantle wrench.
- Calibration is performed on several points, to compensate for nonlinear behaviour of spring.
- Fitted with a micro USB port, for firmware updates.



665SW	1	006650100
-------	---	-----------

666N

click-type torque wrenches with reversible ratchets, for right-hand tightening, torque accuracy: $\pm 3\%$



UNI EN ISO 6789

Nm	Kgfm	lbf.ft	mm	D mm	A mm	L mm	g
5÷25	0,5÷2,5	4÷18	1/4	25	29	220	300

666N/2	1	006660002
--------	---	-----------

Nm	Kgfm	lbf.ft	mm	D mm	A mm	L mm	g
5÷25	0,5÷2,5	4÷18	3/8	25	29	220	300

666N/2X	1	006660003
---------	---	-----------

Nm	Kgfm	lbf.ft	mm	D mm	A mm	L mm	g
10÷50	1÷5	7÷37	3/8	30	33	325	660

666N/5	1	006660005
--------	---	-----------

Nm	Kgfm	lbf.ft	mm	D mm	A mm	L mm	g
20÷100	2÷10	15÷75	3/8	30	33	367	730

666N/10	1	006660010
---------	---	-----------

Nm	Kgfm	lbf.ft	mm	D mm	A mm	L mm	g
20÷100	2÷10	15÷75	1/2	30	37	367	800

666N/10X	1	006660011
----------	---	-----------

Nm	Kgfm	lbf.ft	mm	D mm	A mm	L mm	g
40÷200	4÷20	30÷150	1/2	40	43	465	1010

666N/20	1	006660020
---------	---	-----------

Nm	Kgfm	lbf.ft	mm	D mm	A mm	L mm	g
60÷300	6÷30	50÷220	1/2	40	43	581	1380

666N/30	1	006660030
---------	---	-----------

666N LBF.IN

click-type torque wrenches with reversible ratchets, for right-hand tightening torque accuracy: $\pm 3\%$
• Scale in pounds force per inch



UNI EN ISO 6789

lbf.in	■	D mm	A mm	L mm	g
90÷440	3/8	30	33	325	660

666N-LBF.IN/5 1 006660055

lbf.in	■	D mm	A mm	L mm	g
200÷800	3/8	30	33	367	730

666N-LBF.IN/10 1 006660070

lbf.in	■	D mm	A mm	L mm	g
200÷800	1/2	30	37	367	800

666N-LBF.IN/10X 1 006660071

lbf.in	■	D mm	A mm	L mm	g
400÷1800	1/2	40	43	465	1010

666N-LBF.IN/20 1 006660072

lbf.in	■	D mm	A mm	L mm	g
500÷3000	1/2	40	43	581	1380

666N-LBF.IN/30 1 006660073

667N

click-type torque wrenches with push-through ratchets, for right-hand and left-hand tightening, torque accuracy: $\pm 3\%$



UNI EN ISO 6789

Nm	Kgfm	lbf.ft	■	D mm	A mm	L mm	g
40÷200	4÷20	30÷150	1/2	40	43	465	1010

667N/20 1 006670020

Nm	Kgfm	lbf.ft	■	D mm	A mm	L mm	g
60÷300	6÷30	50÷220	1/2	40	43	581	1380

667N/30 1 006670030

Nm	Kgfm	lbf.ft	■	D mm	A mm	L mm	g
80÷400	8÷40	60÷295	3/4	50	50	687	2090

667N/40 1 006670040

Spare parts rotating mechanism of ratchets, see table after item 929/C8

668N

click-type torque bars, for right-hand and left-hand tightening, torque accuracy: $\pm 3\%$



UNI EN ISO 6789

Nm	Kgfm	lbf.ft	Ø mm	L mm	LB mm	LS mm	g
5÷25	0,5÷2,5	4÷18	16	220	148	32	300

668N/2 1 006680002

Nm	Kgfm	lbf.ft	Ø mm	L mm	LB mm	LS mm	g
10÷50	1÷5	7÷37	16	307	229	32	590

668N/5 1 006680005

Nm	Kgfm	lbf.ft	Ø mm	L mm	LB mm	LS mm	g
20÷100	2÷10	15÷75	16	376	269	32	670

668N/10 1 006680010

Nm	Kgfm	lbf.ft	Ø mm	L mm	LB mm	LS mm	g
40÷200	4÷20	30÷150	16	450	352,6	32	795

668N/20 1 006680020

Nm	Kgfm	lbf.ft	Ø mm	L mm	LB mm	LS mm	g
60÷300	6÷30	50÷220	16	588	475,9	32	1230

668N/30 1 006680030

668RG

click-type torque bar, ungraduated for right-hand and left-hand tightening torque accuracy: $\pm 4\%$ (to be used with items 680 - 682)



UNI EN ISO 6789

Nm	Kgfm	lbf.ft	Ø mm	L mm	g
8÷60	0,8÷6	6÷44	16	288	550

668RG/6 1 006680206

Nm	Kgfm	lbf.ft	Ø mm	L mm	g
20÷100	2÷10	15÷80	16	315	600

668RG/10 1 006680210

Nm	Kgfm	lbf.ft	Ø mm	L mm	g
40÷200	4÷20	30÷150	16	405	780

668RG/20 1 006680220

Nm	Kgfm	lbf.ft	Ø mm	L mm	g
60÷300	6÷30	50÷220	16	645	1130

668RG/30 1 006680230

669N

click-type torque bars, rectangular drive, for right-hand and left-hand tightening, torque accuracy: $\pm 3\%$

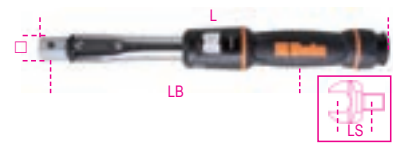

UNI EN ISO 6789

Nm	Kgfm	lbf.ft	□ mm	L mm	LB mm	LS mm	g
5÷25	0,5÷2,5	4÷18	9x12	215	140	28,8	300

669N/2 1 006690202

Nm	Kgfm	lbf.ft	□ mm	L mm	LB mm	LS mm	g
10÷50	1÷5	7÷37	9x12	307	226,8	28,8	590

669N/5 1 006690205

Nm	Kgfm	lbf.ft	□ mm	L mm	LB mm	LS mm	g
20÷100	2÷10	15÷75	9x12	376	266,8	28,8	670

669N/10 1 006690210

Nm	Kgfm	lbf.ft	□ mm	L mm	LB mm	LS mm	g
40÷200	4÷20	30÷150	9x12	450	345,6	28,8	795

669N/20 1 006690220

 **Beta**

Nm	Kgfm	lbf.ft	□ mm	L mm	LB mm	LS mm	g
40±200	4±20	30±150	14x18	450	351	39,8	795

669N/20X 1 006690221

Nm	Kgfm	lbf.ft	□ mm	L mm	LB mm	LS mm	g
60±300	6±30	50±220	14x18	588	468,5	39,8	1230

669N/30 1 006690230

Nm	Kgfm	lbf.ft	□ mm	L mm	LB mm	LS mm	g
80±400	8±40	60±295	14x18	588	563	39,8	2100

669N/40 1 006690240

671B/C5

torque bar item 604B/5 and accessories



671B/C5 1 006710001

604B/5	1+5 Nm
611	1/4
641	5-6-7-8 mm
900	4-5-5,5-6-7-8-9-10 mm

270x120x45 mm - 1,3 kg

671B/C10

torque bar item 604B/10 and accessories



671B/C10 1 006710002

604B/10	2+10 Nm
611	1/4
641	6-7-8-10 mm
900	4-5-5,5-6-7-8-9-10 mm

270x120x45 mm - 1,4 kg

671N/C10

torque bar 668N/10 and accessories



671N/C10 1 006710110

668N/10	100 Nm
612	3/8
617	3/8
642	10-13-14-17-19 mm
652	10-13-14-17-19 mm
910A	□ 3/8 8-10-11-13-14-17-19 mm
910/21	125 mm
910/22	250 mm

400x180x45 mm - 4,3 kg

671N/C20

torque bar 668N/20 and accessories



671N/C20 1 006710120

668N/20	200 Nm
614	1/2
619	1/2
642	10-13-14-17-19 mm
652	10-13-14-17-19 mm
920A	□ 1/2 10-11-13-14-17-19-22 mm
920/20	75 mm
920/21	125 mm
920/22	255 mm

510x180x45 mm - 5,5 kg

671N/C30

torque bar 668N/30 and accessories



671N/C30 1 006710130

668N/30	300 Nm
614	1/2
619	1/2
642	13-14-17-19 mm
652	13-14-17-19 mm
920A	□ 1/2 13-14-17-19-22-24-27 mm
920/20	75 mm
920/21	125 mm
920/22	255 mm

620x180x45 mm - 5,8 kg

677

break-back torque wrenches with push-through ratchets for right-hand and left-hand tightening torque accuracy: ±4%

3/4"



UNI EN ISO 6789

Nm	Kgfm	lbf.ft	D mm	A mm	L mm	kg
100÷500	10÷50	70÷350	70	55	915	5,2

677/50 1 006770050

Nm	Kgfm	lbf.ft	D mm	A mm	L mm	kg
150÷700	15÷70	100÷500	70	55	1140	6,2

677/70 1 006770070

Nm	Kgfm	lbf.ft	D mm	A mm	L mm	kg
300÷1000	30÷100	200÷750	70	55	1470	7,5

677/100 1 006770100

677/C

break-back torque wrenches with push-through ratchets, for right-hand and left-hand tightening torque accuracy: ±4% in case

3/4"



UNI EN ISO 6789

Nm	Kgfm	lbf.ft	D mm	A mm	L mm	kg
100÷500	10÷50	70÷350	70	55	915	5,2

677/C50 1 006770606

Nm	Kgfm	lbf.ft	D mm	A mm	L mm	kg
150÷700	15÷70	100÷500	70	55	1140	6,2

677/C70 1 006770611

Nm	Kgfm	lbf.ft	D mm	A mm	L mm	kg
300÷1000	30÷100	200÷750	70	55	1470	7,5

677/C100 1 006770615

Nm	Kgfm	lbf.ft	D mm	A mm	L mm	kg
700÷1500	70÷150	500÷1000	70	70	1475	10,4

677/C150 1 006770620

677/CP200

break-back torque wrenches with push-through ratchets for right-hand and left-hand tightening torque accuracy: $\pm 4\%$ in case



UNI EN ISO 6789

Nm	kgfm	lbf.in	D mm	A mm	L mm	kg
900÷2000	90÷200	600÷1500	70	63	1920	13

677/CP200 1 006770720

678/C

click-type torque wrenches with push-through ratchets for right-hand and left-hand tightening, torque accuracy: $\pm 4\%$ in case

• Models 678/C100 and 678/C150 supplied complete with extensions.

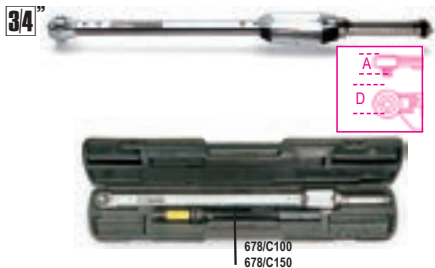

UNI EN ISO 6789

Nm	Kgfm	lbf.ft	D mm	A mm	L mm	kg
130÷650	13÷65	100÷480	63	55	885	3,9

678/C65 1 006780607

Nm	Kgfm	lbf.ft	D mm	A mm	L mm	kg
300÷1000	30÷100	220÷750	75	60	1250	6,0

678/C100 1 006780611

Nm	Kgfm	lbf.ft	D mm	A mm	L mm	kg
500÷1500	50÷150	370÷1100	75	60	1570	8,5

678/C150 1 006780615

677/CV - 678/CV

empty cases for torque wrenches items 677 and 678



677/CV1 1 006770450

677/C50-677/C70

678/CV2 1 006780500

678/C100

678/CV3 1 006780415

677/C100-677/C150-678/C150

680

electronic digital torque meter Dynatester 680 for checking calibration, can be used both clockwise and anticlockwise

- Accuracy: $\pm 1\%$
- 3 measuring units: Nm - lbf.ft. - lbf.in

CE



	Nm	kg		
680/2,5	1÷25	2,6	1	006800002
680/40	15÷400	4,0	1	006800040
680/100	100÷1000	4,8	1	006800100

682

electronic digital torque meter with transducer Dynatester 682 to be used either clockwise or anticlockwise

Remarkable reading accuracy
Supplied with serial output RS 232 for printers



682/60	10
682/400	22
682/1500	36

TECHNICAL FEATURES

- Reading accuracy $\pm 1\%$ of the read value
- Available measuring units Nm-dNm-cNm-lbf.ft-lbf.in-Ozf.in-Kgf.m-Kgf.cm-gf.cm
- Supply range 90 to 264 V AC at 50/60 Hz
- Dimensions 235x185x185 mm
- Tolerance test according to norm ISO 6789
- Acceptability range for each torque wrench tested
- Display Menu available in 11 languages
- Provided with all certificates required
- Calibration certificate with UKAS traceability

	Nm	kg		
682/60	1,2÷60	5,9	1	006820006
682/400	8÷400	6,1	1	006820040
682/1500	30÷1500	6,4	1	006820150

710

impact sockets, standard series



UNI/ISO 2725 DIN 3129

mm	Ø mm	L mm	Ø1 mm		
7	12,5	28	19	3	007100007
8	13,8	28	19	3	007100008
9	15,0	28	19	3	007100009
10	16,3	28	19	3	007100010
11	17,5	30	19	3	007100011
12	19,0	30	19	3	007100012
13	20,0	30	22	3	007100013
14	21,3	30	22	3	007100014
16	23,8	30	22	3	007100016
17	25,0	30	22	3	007100017
18	26,3	30	22	3	007100018
19	27,5	30	22	3	007100019
21	30,0	32	22	3	007100021
22	32,0	32	22	3	007100022

710/16

impact adaptor, 3/8" female and 1/2" male drives



L mm	Ø mm	□	■		
32	22	3/8	1/2	3	007100810

710/20

3/8" drive impact extension bar



L mm	Ø mm		
75	22	2	007100821

710/21

3/8" drive impact extension bar



L mm	Ø mm		
125	22	2	007100823

710/25

3/8" drive impact universal joint

3/8"



L	Ø
mm	mm
58	24

2	007100830
---	-----------

710/C10

10 impact sockets

3/8"



710/C10
7-8-10-11-12-13
14-17-19-22 mm

1	007100910
---	-----------

130x55x40 mm - 800 g

710/OR... - 710/SP...

rubber O-rings and locking pins for impact sockets

3/8"



	710 Ø mm	710/16 L mm	
710/OR1	7-12		10 007100921
710/OR2	13-22	32	10 007100922
710/SP1	7-12		10 007100911
710/SP2	13-22	32	10 007100912

720

impact sockets, standard series

12"



UNI/ISO 2725 DIN 3129

Ø mm	Ø mm	L mm	Ø1 mm	
8	15,0	38	25	5 007200008
9	16,0	38	25	5 007200009
10	17,0	38	25	5 007200010
11	18,5	38	25	5 007200011
12	20,0	38	25	5 007200012
13	21,0	38	25	5 007200013
14	22,5	38	25	5 007200014
15	23,0	38	30	5 007200015
16	25,0	38	30	5 007200016
17	26,0	38	30	5 007200017
18	27,5	38	30	5 007200018
19	28,5	38	30	5 007200019
21	31,0	38	30	5 007200021

Ø mm	Ø mm	L mm	Ø1 mm	
22	32,5	38	30	5 007200022
23	34,0	38	30	5 007200023
24	35,0	38	30	5 007200024
27	38,5	45	30	3 007200027
30	42,0	50	30	3 007200030
32	44,0	50	30	3 007200032
36	50,0	50	30	3 007200036

720AS

impact sockets, standard series

12"



Ø mm	Ø mm	L mm	Ø1 mm	
3/8	17,0	38	25	2 007200210
7/16	18,2	38	25	2 007200211
1/2	20,7	38	25	2 007200213
9/16	22,0	38	25	2 007200214
5/8	24,5	38	30	2 007200216
11/16	25,7	38	30	2 007200217
3/4	28,2	38	30	2 007200219
13/16	30,7	38	30	2 007200221
7/8	32,0	38	30	2 007200222
15/16	34,5	38	30	2 007200224
1	35,7	38	30	2 007200225
1.1/16	38,2	40	30	1 007200227
1.1/8	40,7	42	30	1 007200229
1.1/4	44,5	42	30	1 007200232

720L

impact sockets, long series

12"



UNI/ISO 2725

Ø mm	Ø mm	L mm	Ø1 mm	
10	17,0	80	25	2 007200310
11	18,5	80	25	2 007200311
12	20,0	80	25	2 007200312
13	21,0	80	25	2 007200313
14	22,5	80	25	2 007200314
15	23,0	80	30	2 007200315
16	25,0	80	30	2 007200316
17	26,0	80	30	2 007200317
18	27,5	80	30	2 007200318
19	28,5	80	30	2 007200319
21	31,0	80	30	2 007200321
22	32,5	80	30	2 007200322
24	35,0	80	30	2 007200324
27	38,5	80	30	2 007200327
30	42,0	80	30	2 007200330
32	44,0	80	30	2 007200332
36	50,0	80	30	2 007200336

720L/S3

set of 3 impact sockets item 720L

12"



17-19-21	1	007200355
----------	---	-----------

720LS

impact sockets, long, slim series

12"



UNI/ISO 2725

Ø mm	Ø mm	L mm	Ø1 mm	
10	15,5	78	24	2 007200360
11	16,7	78	24	2 007200361
12	18,0	78	24	2 007200362
13	19,2	78	24	2 007200363
14	20,5	78	24	2 007200364
15	21,7	78	24	2 007200365
16	23,0	78	24	2 007200366
17	24,2	78	29	2 007200367
18	25,5	78	29	2 007200368
19	26,7	78	29	2 007200369
21	29,2	78	29	2 007200371
22	30,5	78	29	2 007200372
24	33,0	78	29	2 007200374
27	36,7	78	29	2 007200377
30	40,5	78	29	2 007200380
32	43,0	78	29	2 007200382
36	48,0	78	29	2 007200386

720LC

wheel nut impact sockets, with coloured polymeric inserts

12"

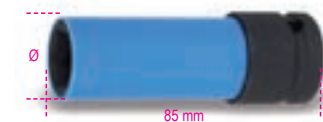

Ø mm	Ø mm	
17	26,5	2 007200637
19	28,5	2 007200639
21	30,3	2 007200641
22	32,4	2 007200642
24	34,6	2 007200644

12"



720LC/C3
17-19-21 mm

1	007200653
---	-----------

148x132x44 mm - 860 g

12"



720LC/S5
17-19-21-22-24 mm

1	007200645
---	-----------

720IC

spare coloured polymeric inserts for impact sockets 720LC-720LCL



	mm			
720IC 17	17		1	007200687
720IC 19	19		1	007200689
720IC 21	21		1	007200691
720IC 22	22		1	007200692
720IC 24	24		1	007200694

720LCL

wheel nut impact sockets with coloured polymeric inserts, long series



	mm	Ø mm		
17	26,5		1	007200737
19	28,5		1	007200739
21	30,3		1	007200741



720LCL/C3				
17-19-21 mm			1	007200753
210x50x150 mm		-	1,65 kg	

720MRC

impact socket with polymeric insert for Mercedes wheel screw



	mm	Ø mm	L mm		
17	27	85	1/2	1	007200631

Beta

720TC

impact torsion bars, coloured, for motor vehicle wheel nuts, with 1/2" male and female square drives

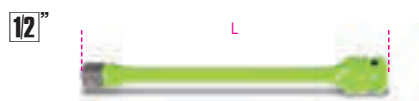

	Nm	L mm		
90	200		1	007200769
100	200		1	007200770
110	200		1	007200771
120	200		1	007200772
135	200		1	007200773



720TC/S5				
90-100-110-120-135 Nm			1	007200779
260x50x175 mm		-	1,35 kg	

720FTX

impact sockets, for Torx® head screws



	Ø mm	L mm	Ø1 mm		
E10	14,0	38	25	2	007200410
E12	15,9	38	25	2	007200412
E14	17,7	38	25	2	007200414
E16	20,0	38	25	2	007200416
E18	22,0	38	25	2	007200418
E20	25,0	40	25	2	007200420
E24	30,0	40	30	2	007200424



720FTX/SB6				
E10-E12-E14-E16-E18-E20			1	007200450

720TX

impact socket drivers for Torx® head screws



	Ø mm	L mm	L1 mm		
T30	25	78	54	3	007200460
T40	25	78	54	3	007200470
T45	25	78	54	3	007200472
T50	25	78	54	3	007200474
T55	25	78	54	3	007200476
T60	25	78	54	3	007200478

720TX/C6

6 impact socket drivers for Torx® head screws



720TX/C6				
T30-T40-T45-T50-T55-T60			1	007200483

275x120x65 mm - 5700 g

720ME

impact socket drivers for hexagon screws



	mm	Ø mm	L mm	L1 mm		
5	25	78	54	3	007200505	
6	25	78	54	3	007200506	
8	25	78	54	3	007200508	
10	25	78	54	3	007200510	
12	25	78	54	3	007200512	
14	25	78	54	3	007200514	
17	25	78	54	3	007200517	
19	25	78	54	3	007200519	

Beta

Beta

720ME/C8

8 impact socket drivers for hexagon screws

12"



720ME/C8
5-6-8-10-12
14-17-19 mm

1 007200525

270x120x45 mm - 1710 g

720/15

impact adaptor, 1/2" female and 3/8" male drives

12"



L mm 37,5
Ø mm 25
1/2 3/8

3 007200810



Always apply torque loads evenly and progressively to avoid breakage and any possible injury.

720/16

impact adaptor, 1/2" female and 3/4" male drives

12"



L mm 44
Ø mm 30
1/2 3/4

3 007200814

720/20

1/2" drive impact extension bar

12"



L mm 75
Ø mm 25

3 007200818

720/21

1/2" drive impact extension bar

12"



L mm 125
Ø mm 25

3 007200822

720/25

1/2" drive impact universal joint

12"



L mm 64
Ø mm 28

2 007200831

720/C6

6 impact sockets

12"



720/C6
13-14-17-19-22-24 mm

1 007200910

195x80x55 mm - 1100 g

720/C12

12 impact sockets

12"



720/C12
10-11-12-13-14-17
19-22-24-27-30-32 mm

1 007200912

195x80x55 mm - 2000 g

720/OR... - 720/SP...

rubber O-rings and locking pins for impact sockets

12"

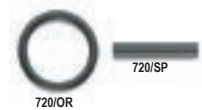

	720 mm	720TX T30-T60	
720/OR1	10-14	T30-T60	10 007200923
720/OR2	15-32		10 007200924
720/SP1	10-14	T30-T60	10 007200913
720/SP2	15-32		10 007200914

727PI/16

impact bit holder for item 727/ES16 and 727/ES16TX

3/4"



Ø mm 44
L mm 52
Hex mm 16
3/4"

2 007270016

727/ES16

impact hexagon bits, 16 mm drive

12"



mm	Ø mm	L mm	
10	16	40	2 007270110
12	16	40	2 007270112
13	16	40	2 007270113
14	16	40	2 007270114
16	16	40	2 007270116
17	16	40	2 007270117
18	16	40	2 007270118
19	16	40	2 007270119
22	16	40	2 007270122

727/ES16TX

impact bits for Torx® head screws, 16 mm drive

12"



	Ø mm	L mm	
T55	16	50	2 007270355
T60	16	50	2 007270360
T70	16	50	2 007270370



727PI/22

impact bit holder for item 727/ES22 and 727/ES22TX



Ø mm	L mm	Ø mm	
54	70	22	2 007270022

727/ES22

impact hexagon bits, 22 mm drive



mm	mm	L mm	
19	22	50	2 007270219
22	22	50	2 007270222
24	22	50	2 007270224
27	22	50	2 007270227
30	22	50	2 007270230
32	22	50	2 007270232

727/ES22TX

impact bits for Torx® head screws, 22 mm drive



mm	mm	L mm	
T80	22	60	2 007270480
T90	22	60	2 007270490
T100	22	60	2 007270500

727/C16

12 impact bits and 4 accessories



727/C16 1 007270900

- 727PI16
- 727/ES16 14-17-19 mm
- 727/ES16TX T55-T60-T70
- 727PI22
- 727/ES22 22-24-27 mm
- 727/ES22TX T80-T90-T100

96BPC 3-4 mm
335x145x60 mm - 3,6 kg

727PI/32

impact bit holder for item 727/ES32

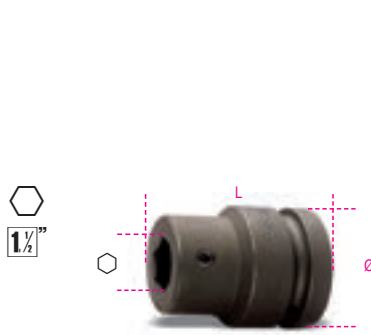

Ø mm	L mm	Ø mm	
86	66	32	1 007270032

727/ES32

impact hexagon bit, 32 mm drive



mm	mm	L mm	
19	32	44	2 007270519
22	32	44	2 007270522
24	32	44	2 007270524
27	32	44	2 007270527
30	32	44	2 007270530
32	32	44	2 007270532
36	32	44	2 007270536

728

impact sockets, standard series



UNI/ISO 2725 DIN 3129

mm	Ø mm	L mm	Ø1 mm	
17	30,0	51	44	2 007280017
18	31,0	51	44	2 007280018
19	32,5	51	44	2 007280019
21	35,0	51	44	2 007280021
22	36,0	51	44	2 007280022
23	37,5	51	44	2 007280023
24	38,5	51	44	2 007280024
27	42,5	53	44	2 007280027
28	44,0	53	44	2 007280028
30	46,0	53	44	2 007280030
32	48,5	57	44	2 007280032
33	50,0	57	44	2 007280033
34	51,0	57	44	2 007280034
35	52,5	57	44	2 007280035
36	53,5	57	44	2 007280036
38	56,0	57	44	1 007280038
40	58,5	58	44	1 007280040
41	60,0	58	44	1 007280041
44	64,0	62	44	1 007280044
45	65,0	62	44	1 007280045
46	66,0	62	44	1 007280046
50	71,0	68	54	1 007280050
55	77,5	71	54	1 007280055
60	83,0	73	54	1 007280060
65	88,0	78	54	1 007280065

728AS

impact sockets, standard series



mm	Ø mm	L mm	Ø1 mm	
3/4	32,0	51	41	1 007280219
13/16	35,0	51	41	1 007280221
7/8	36,0	51	41	1 007280222
15/16	38,5	51	41	1 007280224
1	40,0	53	41	1 007280225
1.1/16	42,5	53	44	1 007280227
1.1/8	44,0	53	44	1 007280230
1.1/4	48,5	57	44	1 007280232
1.5/16	50,0	57	44	1 007280233
1.7/16	53,5	57	44	1 007280236
1.1/2	56,0	57	44	1 007280238
1.5/8	60,0	58	44	1 007280241

728FTX

impact sockets, for Torx® head screws



mm	Ø mm	L mm	Ø1 mm	
E20	28,5	50	44	2 007280420
E22	30,0	50	44	2 007280422
E24	32,5	50	44	2 007280424

728L

impact sockets, long series



mm	Ø mm	L mm	Ø1 mm	
19	32,5	90	44	2 007280319
21	35,0	90	44	2 007280321
22	36,0	90	44	2 007280322
24	38,5	90	44	2 007280324
26	41,0	90	44	2 007280326
27	42,5	90	44	2 007280327
30	46,0	90	44	2 007280330
32	48,5	90	44	2 007280332
33	50,0	90	44	1 007280333
34	51,0	90	44	1 007280334
36	53,5	90	44	1 007280336
38	56,0	90	44	1 007280338
41	60,0	90	44	1 007280341
44	64,0	90	44	1 007280344
46	66,0	90	44	1 007280346
50	71,0	90	44	1 007280350
55	77,5	100	54	1 007280355

728LS

impact sockets, long slim series



mm	Ø mm	L mm	Ø1 mm	
17	28,0	100	43	2 007280517
19	30,5	100	43	2 007280519
22	34,3	100	43	2 007280522
24	36,8	100	43	2 007280524

mm	Ø mm	L mm	Ø1 mm		
27	40,5	100	43	2	007280527
30	44,3	100	43	2	007280530
32	46,8	100	43	2	007280532
33	48,0	100	43	2	007280533
36	51,8	100	43	1	007280536

728LQ

impact sockets, long series

(for ISUZU wheel nuts)



mm	L mm	Ø mm	Ø1 mm		
19	90	35	43,5	1	007280619
21	90	42	43,5	1	007280621

728/15

impact adaptor, 3/4" female and 1/2" male drives



L mm	Ø mm	□	■		
58	38	3/4	1/2	2	007280810



Always apply torque loads evenly and progressively to avoid breakage and any possible injury.

728/16

impact adaptor, 3/4" female and 1" male drives



L mm	Ø mm	□	■		
62	44	3/4	1	2	007280813

728/21

3/4" drive impact extension bar



L mm	Ø mm		
175	44	2	007280815

728/22

3/4" drive impact extension bar



L mm	Ø mm		
250	44	2	007280825

728/22L

3/4" drive impact extension bar



L mm	Ø mm		
330	44	1	007280826

728/25

3/4" drive impact universal joint



L mm	Ø mm		
107,5	44	1	007280830

728/C10

10 impact sockets



728/C10		
17-19-22-24-27-30	1	007280910
32-36-41-46 mm		

275x120x65 mm - 5,7 kg

728/OR - 728/SP

rubber O-rings and locking pins for impact sockets



728/OR	728/SP		
728/OR	728/15	5	007280925
728/OR	17+46	10	007280926
728/SP	17+46	10	007280916

729

impact sockets, standard series



UNI/ISO 2725 DIN 3129

mm	Ø mm	L mm	Ø1 mm		
24	41,5	58	54	1	007290024
27	45,0	60	54	1	007290027
30	49,0	62	54	1	007290030
32	51,5	63	54	1	007290032
33	52,5	63	54	1	007290033
34	54,0	63	54	1	007290034
36	56,5	66	54	1	007290036
38	59,0	66	54	1	007290038
41	62,5	68	54	1	007290041
46	69,0	72	54	1	007290046
50	74,0	76	54	1	007290050
55	80,0	84	54	1	007290055
60	86,5	88	54	1	007290060
65	92,5	92	54	1	007290065
70	99,0	96	54	1	007290070
75	105,0	102	63	1	007290075
80	111,5	102	63	1	007290080

729L

impact sockets, long series



mm	Ø mm	L mm	Ø1 mm		
24	41,5	108	54	1	007290324
27	45,0	108	54	1	007290327
30	49,0	108	54	1	007290330
32	51,5	108	54	1	007290332
33	52,2	108	54	1	007290333
34	54,0	108	54	1	007290334
36	56,5	108	54	1	007290336
41	62,5	108	54	1	007290341
46	69,0	108	54	1	007290346
50	74,0	108	54	1	007290350
55	80,0	108	54	1	007290355
60	86,5	108	54	1	007290360
65	92,5	108	54	1	007290365
70	99,0	108	54	1	007290370
75	105,0	108	63	1	007290375
80	111,5	108	63	1	007290380

729LS

impact sockets, long slim series



mm	Ø mm	L mm	Ø1 mm		
22	36,0	108	53	1	007290522
24	38,5	108	53	1	007290524
27	42,3	108	53	1	007290527
30	46,0	108	53	1	007290530
32	48,5	108	53	1	007290532
33	49,8	108	53	1	007290533
36	53,5	108	53	1	007290536

729T

impact torsion bars for wheel nuts



mm	Nm	L mm	
24	350	300	1 007290724
27	450	300	1 007290757
30	500	300	1 007290730
32	450	300	1 007290732
32	600	300	1 007290762
33	600	300	1 007290763
36	600	300	1 007290736

729/15

impact adaptor, 1" female and 3/4" male drives



L mm	Ø mm	□	■	
66,5	54	1	3/4	1 007290810

Always apply torque loads evenly and progressively to avoid breakage and any possible injury.

729/16

impact adaptor, 1" female and 1.1/2" male drives



L mm	Ø mm	□	■	
88	54,0	1	1.1/2	1 007290813

729/21

1" drive impact extension bar



L mm	Ø mm	
175	54	1 007290815

729/22

1" drive impact extension bar



L mm	Ø mm	
330	54	1 007290825

729/25

1" drive impact universal joint



L mm	Ø mm	
130	54	1 007290830

729/OR... - 729/SP...

rubber O-rings and locking pins for impact sockets



	728 mm	729-730 mm	
729/OR1	50+60	24+70	5 007290927
729/OR2		75+125	5 007290928
729/SP1	50+60	24+70	5 007290917
729/SP2		75+125	5 007290918

730

impact sockets, standard series



UNI/ISO 2725 DIN 3129

mm	Ø mm	L mm	Ø1 mm	
50	81	87	84	1 007300050
55	88	90	86	1 007300055
60	94	95	86	1 007300060
65	100	100	86	1 007300065
70	106	105	86	1 007300070
75	113	110	86	1 007300075
80	119	115	86	1 007300080
85	125	120	86	1 007300085
90	132	125	86	1 007300090
95	138	125	96	1 007300095
100	144	130	96	1 007300100
105	150	135	96	1 007300105
110	157	140	96	1 007300110
115	163	140	96	1 007300115
120	169	145	96	1 007300120
125	175	145	96	1 007300125

730/15

adaptor



L mm	Ø mm	□	■	
105	84,0	1.1/2	1	1 007300810



Always apply torque loads evenly and progressively to avoid breakage and any possible injury.

733/15

adaptor



L mm	Ø mm	□	■	
156	127	2.1/2	1.1/2	1 007330810

851

magnetic bit holder with handle

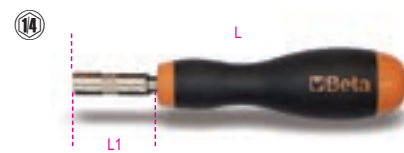

L1 mm	L mm	
45	165	2 008510165
125	245	2 008510245

851SR

quick release bit holder with handle



L mm	L1 mm	
230	110	2 008510001

852

bit holder with articulated T handle

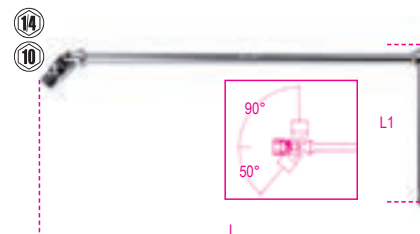

□	L mm	L1 mm	
1/4"	400	160	2 008520006
10 mm	400	160	2 008520010

855P

reversible ratchet bit holder with articulated handle, and 7 built-in bits

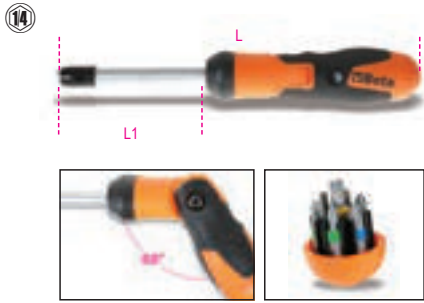

L mm	L1 mm		
240	100	1	008550010

	860PH	PH1 - PH2
	860PZ	PZ1 - PZ2
	860LP	LP 0,8X5,5 mm
	860PE	4 - 5 mm

860LP

bits for slotted head screws, coloured



ISO 2351-1
ISO 1173 C 6,3

SxA mm	L mm		
0,5x3	25	5	008600005
0,6x4,5	25	5	008600010
0,8x5,5	25	5	008600015
1x5,5	25	5	008600020
1,2x6,5	25	5	008600025

860PH

bits for cross head Phillips® screws, coloured



ISO 2351-2
ISO 1173 C 6,3

PH	L mm		
0	25	5	008600220
1	25	5	008600225
2	25	5	008600230
3	25	5	008600245
4	25	5	008600250



860PZ

bits for cross head Pozidriv® - Supadriv® screws, coloured



ISO 2351-2
ISO 1173 C 6,3

PZ	L mm		
1	25	5	008600320
2	25	5	008600325
3	25	5	008600330
4	25	5	008600335

860PE

hexagon bits for power drivers, coloured



ISO 2351-3
ISO 1173 C 6,3

mm	L mm		
2	25	5	008600101
2,5	25	5	008600102
3	25	5	008600103
4	25	5	008600104
5	25	5	008600105
6	25	5	008600106
8	25	5	008600108
10	25	5	008600110

860TX

bits for Torx® head screws, coloured



ISO 1173 C 6,3

	L mm		
T6	25	5	008600704
T7	25	5	008600705
T8	25	5	008600710
T9	25	5	008600715
T10	25	5	008600720
T15	25	5	008600725
T20	25	5	008600730
T25	25	5	008600735
T27	25	5	008600740
T30	25	5	008600745
T40	25	5	008600750

860RTX

bits for Tamper Resistant Torx® head screws, coloured



ISO 1173 C 6,3

	L mm		
T9	25	5	008600550
T10	25	5	008600555
T15	25	5	008600560
T20	25	5	008600565
T25	25	5	008600570
T27	25	5	008600575
T30	25	5	008600580
T40	25	5	008600585

860/55

reversible bit ratchet



860/58

bit ratchet with rotating handle

- Bit can be fitted onto both sides, for screwing or unscrewing
- Bi-material handle



	L mm	Ø mm	A mm		
860/58	126	1/4"	27	15	1 008600884



860/C27

25 bits, 1 connector and 1 reversible ratchet in plastic case



860/C27 1 008600880

	860/55	100 mm	
	860LP	0,5x3-1,0x5,5-1,2x6,5 mm	
	860PH	PH1-PH2(x2)-PH3	
	860PZ	PZ1-PZ2(x2)-PZ3	
	860PE	2-2,5-3-4-5-6 mm	
	860TX	T6-T8-T10-T15-T20-T25-T30-T40	
	892/0	● 1/4 ■ 1/4	

860PHZ/A10

set of 10 bits with magnetic bit holder in plastic case



860PHZ/A10 1 008600910

	860PH	PH1 PH2 PH3	n. 1 3 1
	860PZ	PZ1 PZ2 PZ3	1 3 1
	882M1	○ 1/4 ● 1/4	

860PE/A10

set of 10 bits with magnetic bit holder in plastic case



860PE/A10 1 008600920

	860PE	2 - 2,5 mm 3 - 4 - 5 - 6 mm	n. 1 2
	882M1	○ 1/4 ● 1/4	

860TX/A10

set of 10 bits with magnetic bit holder in plastic case



860TX/A10 1 008600970

	860TX	T7 - T8 - T9 - T10 - T15 - T20 T25 - T27 - T30 - T40	n. 1
	882M1	○ 1/4 ● 1/4	

860MIX/A10

set of 10 bits with magnetic bit holder in plastic case



860MIX/A10 1 008600900

	860LP	0,5x3 - 1x5,5 - 1,2x6,5 mm	n. 1
	860PH	PH1 PH2 PH3	1 2 1
	860PZ	PZ1 - PZ2 - PZ3	1
	882M1	○ 1/4 ● 1/4	

860MIX/A31

set of 30 bits with magnetic quick release bit holder in plastic case



860MIX/A31 1 008600902

	860LP	0,5x3 - 0,6x4 - 0,8x5,5 1,0x5,5 - 1,2x6,5 mm	
	860PE	2 - 2,5 - 3 - 4 - 5 - 6 8 - 10 mm	
	860PH	PH0 - PH1 - PH2 - PH3 - PH4	
	860PZ	PZ1 - PZ2 - PZ3 - PZ4	
	860RTX	T9 - T10 - T15 - T20 T25 - T27 - T30 - T40	
	882MSR/50	○ 1/4 ● 1/4	

860/C38P

1 reversible ratchet bit holder with articulated handle, 27 bits, 8 hexagon sockets and 2 accessories



860/C38P 1 008600878

	860LP	0,6x4,5 - 0,8x5,5 - 1,0x5,5 - 1,2x6,5 mm	
	860PE	2-2,5-3-4(x2)-5(x2)	
	860PH	PH1(x2)-PH2(x2)-PH3	
	860PZ	PZ1(x2)-PZ2(x2)-PZ3	
	860TX	T10-T15-T20-T25-T30-T40	
	900	5-5,5-6-7-8-9-10-13 mm	
	892/0	● 1/4 ■ 1/4	
	892/3	● 1/4 ■ 1/4	
	855P	240 mm	

270x120x45 mm



861LP

bits for slotted head screws



ISO 2351-1

ISO 1173 C 6,3

SxA mm	L mm		
0,5x3	25	10	008610005
0,6x4	25	10	008610007
0,6x4,5	25	10	008610010
0,8x5,5	25	10	008610015
1x5,5	25	10	008610020
1,2x6,5	25	10	008610025
1,2x8	25	10	008610028
1,6x8	25	10	008610030

861PH

bits for cross head Phillips® screws



ISO 2351-2

ISO 1173 C 6,3

PH	L mm		
0	25	10	008610200
1	25	10	008610205
2	25	10	008610210
2L	50	10	008610213
3	25	10	008610215
4	25	10	008610220

861PH/C

bits for cross head Phillips® screws



ISO 2351-2

ISO 1173 C 6,3

PH	L mm		
0	25	200	008610250
1	25	200	008610255
2	25	200	008610260
2L	50	100	008610263
3	25	200	008610265
4	25	100	008610270

861PZ

bits for cross head
Pozidriv®-Supadriv® screws



ISO 2351-2

ISO 1173 C 6,3

PZ	L mm		
1	25	10	008610300
2	25	10	008610305
2L	50	10	008610308
3	25	10	008610310
4	25	10	008610315

861PZ/C

bits for cross head
Pozidriv®-Supadriv® screws



ISO 2351-2

ISO 1173 C 6,3

PZ	L mm		
1	25	200	008610350
2	25	200	008610355
2L	50	100	008610358
3	25	200	008610360
4	25	100	008610365

861PE

hexagon bits for power drivers



ISO 2351-3

ISO 1173 C 6,3

mm	L mm		
2	25	10	008610100
2,5	25	10	008610105
3	25	10	008610110
4	25	10	008610115
5	25	10	008610120
6	25	10	008610125
8	25	10	008610130
10	25	10	008610135

861TX

bits for Torx® head screws



ISO 1173 C 6,3

⊕	L mm		
T5	25	10	008610399
T6	25	10	008610400
T7	25	10	008610405
T8	25	10	008610410
T9	25	10	008610415
T10	25	10	008610420
T15	25	10	008610425
T20	25	10	008610430
T25	25	10	008610435
T27	25	10	008610440
T30	25	10	008610445
T40	25	10	008610450

861TX/C

bits for Torx® head screws



ISO 1173 C 6,3

⊕	L mm		
T10	25	200	008610470
T15	25	200	008610475
T20	25	200	008610480
T25	25	200	008610485
T27	25	200	008610490
T30	25	200	008610495
T40	25	200	008610499

861RTX

bits for Tamper Resistant Torx®
head screws



ISO 1173 C 6,3

⊕	L mm		
T7	25	10	008610538
T9	25	10	008610500
T10	25	10	008610505
T15	25	10	008610510
T20	25	10	008610515
T25	25	10	008610520
T27	25	10	008610525
T30	25	10	008610530
T40	25	10	008610535
T45	25	10	008610539

861RIBE

bits for RIBE® screws



ISO 1173 C 6,3

⊕	L mm		
M5	25	10	008610705
M6	25	10	008610706
M7	25	10	008610707
M8	25	10	008610708
M9	25	10	008610709

861TRW

bits for Tri-Wing® head screws



ISO 1173 C 6,3

GR	L mm		
1	25	10	008610601
2	25	10	008610602
3	25	10	008610603
4	25	10	008610604
5	25	10	008610605
6	25	10	008610606

861TQS

bits for Torq-Set® head screws



ISO 1173 C 6,3

GR	L mm		
0	25	10	008610620
1	25	10	008610621
2	25	10	008610622
3	25	10	008610623
4	25	10	008610624
5	25	10	008610625
6	25	10	008610626
8	25	10	008610628
10	25	10	008610630

861SP

bits for Spanner screws

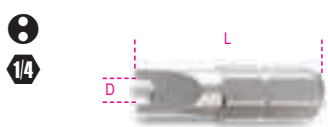

ISO 1173 C 6,3

SP	D mm	L mm		
4	1,5	25	10	008610650
6	2,4	25	10	008610653
8	2,8	25	10	008610656
10	3,3	25	10	008610658
12	3,9	25	10	008610660

1483KV-PT/S7



1483KV PT/S7

166

861XZN

bits for XZN® screws



ISO 1173 C 6,3

Ø	L mm		
M5	25	10	008610725
M6	25	10	008610726
M8	25	10	008610728

861/C61P

61 bits and 1 magnetic quick release bit holder



861/C61P

1 008610978

	861LP	0,5x3 - 0,6x4,5 - 0,8x5,5 - 1,0x5,5 1,2x6,5 - 1,2x8 - 1,6x8 mm
	861PE	2 - 2,5 - 3 - 4 - 5 - 6 - 8 - 10 mm
	861PH	PH0 - PH1 - PH2 - PH3
	861PZ	PZ1 - PZ2 - PZ3
	861TX	T6 - T7 - T8 - T9 - T10 - T15 T20 - T25 - T27 - T30 - T40
	861RTX	T9 - T10 - T15 - T20 - T25 T27 - T30 - T40
	861TRW	1 - 2 - 3 - 4 - 5 - 6
	861TQS	0 - 1 - 2 - 3 - 4 - 5 - 6 - 8 - 10
	861SP	4 - 6 - 8 - 10 - 12
	851SR	Ø 1/4"

270x120x45 mm - 975 g

862LP

bits for slotted head screws



ISO 2351-1

ISO 1173 E 6,3

SxA mm	L mm		
0,5x3	50	5	008620005
0,6x4,5	50	5	008620010
0,8x5,5	50	5	008620015
1x5,5	50	5	008620020
1,2x6,5	50	5	008620025
1,2x8	50	5	008620030
1,6x8	50	5	008620035

862PH

bits for cross head Phillips® screws



ISO 2351-2

ISO 1173 E 6,3

PH	L mm		
1	50	5	008620200
2	50	5	008620205
3	50	5	008620210

862PH/L

bits for cross head Phillips® screws



ISO 2351-2

ISO 1173 E 6,3

PH	L mm		
1	70	5	008620230
2	70	5	008620232
3	70	5	008620234

862PH-XL

bits for cross head Phillips® screws



ISO 2351-2-ISO 1173 E 6,3

PH	L mm		
1	100	5	008620250
2	100	5	008620252
3	100	5	008620254

862PZ

bits for cross head Pozidriv®-Supadriv® screws



ISO 2351-2

ISO 1173 E 6,3

PZ	L mm		
1	50	5	008620300
2	50	5	008620305
3	50	5	008620310

862PE

hexagon bits for power drivers



ISO 2351-3

ISO 1173 E 6,3

mm	L mm		
3	50	5	008620103
4	50	5	008620104
5	50	5	008620105
6	50	5	008620106
8	50	5	008620108

862TX

bits for Torx® head screws



ISO 1173 E 6,3

	L mm		
T6	50	5	008620506
T7	50	5	008620507
T8	50	5	008620508
T9	50	5	008620509
T10	50	5	008620510
T15	50	5	008620515
T20	50	5	008620520
T25	50	5	008620525
T27	50	5	008620527
T30	50	5	008620530
T40	50	5	008620540

862TX/L

bits for Torx® head screws



ISO 1173 E 6,3

	L mm		
T6	70	5	008620556
T7	70	5	008620557
T8	70	5	008620558
T9	70	5	008620559
T10	70	5	008620560
T15	70	5	008620565
T20	70	5	008620570
T25	70	5	008620575
T27	70	5	008620577
T30	70	5	008620580
T40	70	5	008620590

862TX-XL

bits for Torx® head screws



ISO 1173 E 6,3

	L mm		
T9	100	5	008620659
T10	100	5	008620660
T15	100	5	008620665
T20	100	5	008620670
T25	100	5	008620675
T27	100	5	008620677
T30	100	5	008620680
T40	100	5	008620690

862F

magnetic bits, hexagon sockets



ISO 1173 E 6,3

mm	L mm	Ø mm		
5,5	65	11	5	008620405
6	65	11	5	008620406
7	65	11	5	008620407
8	65	13	5	008620408
10	65	15	5	008620410
12	65	18	5	008620412
13	65	18	5	008620413

862F/A7

7 magnetic bits, hexagon sockets, in plastic case



862F/A7

1 008620950

862F 5,5-6-7-8-10-12-13 mm

866LP

bits for slotted head screws



ISO 2351-1
ISO 1173 C 8

SxA mm	L mm		
1x5,5	41	10	008660005
1,2x6,5	41	10	008660010
1,6x8	41	10	008660015
1,6x10	41	10	008660020
2x12	41	10	008660025

866PH

bits for cross head Phillips® screws



ISO 2351-2

ISO 1173 C 8

PH	L mm		
1	32	10	008660200
2	32	10	008660205
3	32	10	008660210
4	38	10	008660215

866PZ

bits for cross head Pozidriv®-Supadriv® screws



ISO 2351-2

ISO 1173 C 8

PZ	L mm		
1	32	10	008660300
2	32	10	008660305
3	32	10	008660310
4	38	10	008660315

866PE

hexagon bits for power drivers



ISO 2351-3

ISO 1173 C 8

mm	L mm		
3	30	10	008660100
4	30	10	008660105
5	30	10	008660110
6	30	10	008660115
7	30	10	008660117
8	30	10	008660120
10	30	10	008660125
12	30	10	008660132
14	30	10	008660134

866TX

bits for Torx® head screws



ISO 1173 C 8

	L mm		
T20	30	10	008660400
T25	30	10	008660405
T27	30	10	008660410
T30	30	10	008660415
T40	30	10	008660420
T45	30	10	008660425
T50	30	10	008660430
T55	30	10	008660435
T60	30	10	008660440
T70	30	10	008660445

866RTX

bits for Tamper Resistant Torx® head screws



ISO 1173 C 8

	L mm		
T40	30	10	008660520
T45	30	10	008660525
T50	30	10	008660530
T55	30	10	008660535
T60	30	10	008660540
T70	30	10	008660545

867PE

hexagon bits



mm	L mm	
4	30	5 008670104
5	30	5 008670105
6	30	5 008670106
7	30	5 008670107
8	30	5 008670108
10	30	5 008670110
12	30	5 008670112

867PE/L

hexagon bits



mm	L mm	
4	75	5 008670154
5	75	5 008670155
6	75	5 008670156
7	75	5 008670157
8	75	5 008670158
10	75	5 008670160
12	75	5 008670162

867XZN

bits with XZN® profile



	L mm	
M4	30	5 008670204
M5	30	5 008670205
M6	30	5 008670206
M8	30	5 008670208
M10	30	5 008670210
M12	30	5 008670212

867XZN/L

bits with XZN® profile



	L mm	
M5	75	5 008670255
M6	75	5 008670256
M8	75	5 008670258
M10	75	5 008670260
M12	75	5 008670262

867TX

bits for Torx® head screws



	L mm	
T20	30	5 008670400
T25	30	5 008670405
T30	30	5 008670410
T40	30	5 008670415
T45	30	5 008670420
T50	30	5 008670425
T55	30	5 008670430

867TX/L

bits for Torx® head screws



	L mm	
T20	75	5 008670450
T25	75	5 008670455
T30	75	5 008670460
T40	75	5 008670465
T45	75	5 008670470
T50	75	5 008670475
T55	75	5 008670480

867RTX

bits for Tamper Resistant Torx® head screws



	L mm	
T20	30	5 008670500
T25	30	5 008670505
T30	30	5 008670510
T40	30	5 008670515
T45	30	5 008670520
T50	30	5 008670525
T55	30	5 008670530

867RTX/L

bits for Tamper Resistant Torx® head screws



	L mm	
T20	75	5 008670550
T25	75	5 008670555
T30	75	5 008670560
T40	75	5 008670565
T45	75	5 008670570
T50	75	5 008670575
T55	75	5 008670580

867RIBE

bits for RIBE® screws



	L mm	
M5	30	5 008670705
M6	30	5 008670706
M7	30	5 008670707
M8	30	5 008670708
M9	30	5 008670709
M10	30	5 008670710
M11	30	5 008670711
M12	30	5 008670712
M13	30	5 008670713

867RIBE/L

bits for RIBE® screws



	L mm	
M5	75	5 008670755
M6	75	5 008670756
M7	75	5 008670757
M8	75	5 008670758
M9	75	5 008670759
M10	75	5 008670760
M11	75	5 008670761
M12	75	5 008670762
M13	75	5 008670763

867/...

bit holder sockets for item 867



	mm	mm	L mm	Ø mm	
867/1	10	3/8"	38	17	5 008670600
867/2	10	1/2"	38	22	5 008670601

867/C20

18 bits for RIBE® screws, with 10 mm hexagon drive and 2 accessories



867/C20		1	5 008670920
---------	--	---	-------------

	867RIBE	5-6-7-8-9-10-11-12-13 mm
	867RIBE/L	5-6-7-8-9-10-11-12-13 mm
	867/1	
	867/2	

335x145x60 mm - 1,7 kg

867/C38

38 hexagon bits, 10 mm, 1 bit holder with articulated T handle



867/C38

1 008670938

852	10 mm
○ 867PE	4-5-6-7-8-10-12mm
○ 867PE/L	4-5-6-7-8-10-12mm
○ 867XZN	M5-M6-M8-M10-M12
○ 867XZN/L	M5-M6-M8-M10-M12
⊕ 867TX	T20-T25-T30-T40-T45-T50-T55
⊕ 867TX/L	T20-T25-T30-T40-T45-T50-T55
882	

420x185x60 mm - 3 kg

867/C52

52 hexagon bits, 10 mm and 2 accessories

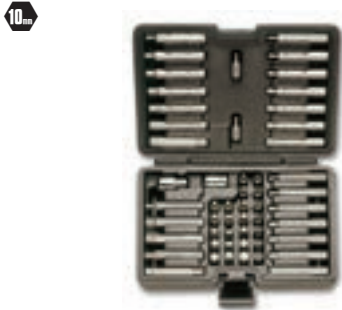

867/C52

1 008670901

○ 867PE	4-5-6-7-8-10-12 mm
○ 867PE/L	4-5-6-7-8-10-12 mm
○ 867XZN	M5-M6-M8-M10-M12
○ 867XZN/L	M5-M6-M8-M10-M12
⊕ 867TX	T20-T25-T30-T40-T45-T50-T55
⊕ 867TX/L	T20-T25-T30-T40-T45-T50-T55
⊕ 867RTX	T20-T25-T30-T40-T45-T50-T55
⊕ 867RTX/L	T20-T25-T30-T40-T45-T50-T55
867/1	○ 10 mm - □ 3/8"
867/2	○ 10 mm - □ 1/2"

250x170x70 mm - 2,1 kg

882

bit holder with retaining ring for drivers



ISO 1173 E 6,3

L mm	○	●	∅ mm	
57	1/4	1/4	11	5 008820001

882AN

bevel gearbox, 1/4" hexagon drive

- For electric drills with 10 mm and 13 mm spindles and 1/4" impact wrenches
- Max. speed: 3600 rpm
- Max. torque: 30 Nm
- With quick change bit holder
- Gear ratio: 1:1
- Connection to tool through 1/4" hexagon D6.3



ISO 1173 E 6,3
ISO 1173 C 6,3

L mm	○	●		
137	1/4	1/4		1 008820090

882M1

magnetic bit holder



ISO 1173 E 6,3

L mm	○	●	∅ mm	
50	1/4	1/4	11	5 008820006

882M

magnetic bit holder



ISO 1173 E 6,3

L mm	○	●	∅ mm	
75	1/4	1/4	11	5 008820005

882MSR

magnetic quick release bit holder for drivers



ISO 1173 E 6,3

L mm	○	●	∅ mm	
50	1/4	1/4	11	5 008820205
75	1/4	1/4	11	5 008820207

882P

magnetic bit holder extension bar



L mm	●	○	∅ mm	
80	1/4	1/4	10	5 008820080

892

adaptors for drivers



	■	●	L mm	
892/0	1/4	1/4	25	5 008920000
* 892/1	1/4	5,5	50	5 008920001
* 892/2	3/8	5,5	50	5 008920002
* 892/3	1/4	1/4	50	5 008920003
* 892/4	3/8	1/4	50	5 008920004
892/5	1/4	5/16	75	5 008920005
892/6	3/8	5/16	75	5 008920006
892/7	1/2	1/4	75	5 008920007

* ISO 1173 A 5,5
° ISO 1173 C 6,3

Beta

895

socket holder for bits
item 861 - 862 - 866



DIN 7427

	□	○	L	Ø		
	mm	mm	mm	mm		
895/1	1/4	1/4	25,4	12	5	008950000
895/3	1/4	3/8	29	16,8	5	008950001
895/4	5/16	3/8	29	16,8	5	008950002
895/5	1/4	1/2	38	22	5	008950005
895/6	5/16	1/2	38	22	5	008950003

897

flexible bit holder with handle



L	L1		
mm	mm		
280	154	2	008970010

897L

flexible bit holder with handle, long model



L	L1		
mm	mm		
500	380	2	008970015

900

hexagon hand sockets



UNI/ISO 2725 DIN 3124

⊕	Ø	L	Ø1		
mm	mm	mm	mm		
4	6,8	25	11,8	10	009000040
4,5	7,4	25	11,8	10	009000045
5	8,0	25	11,8	10	009000050
5,5	8,7	25	11,8	10	009000055
6	9,3	25	11,8	10	009000060
7	10,4	25	11,8	10	009000070
8	11,8	25	12,7	10	009000080
9	12,7	25	11,8	10	009000090
10	14,2	25	12,0	10	009000100
11	15,8	25	12,5	10	009000110
12	17,2	25	13,5	10	009000120
13	18,0	25	13,5	10	009000130
14	20,0	25	15,0	10	009000140



900/SB13		
4-4,5-5-5,5-6-7-8-9	1	009000150
10-11-12-13-14 mm		

900MB

bi-hex hand sockets



UNI/ISO 2725 DIN 3124

⊕	Ø	L	Ø1		
mm	mm	mm	mm		
4	6,7	22	11,2	5	009000160
5	7,7	25	11,2	5	009000161
5,5	8,3	25	11,2	5	009000162
6	9,0	25	11,2	5	009000163
7	10,2	25	11,2	5	009000164
8	11,3	25	12,0	5	009000165
9	13,0	25	12,0	5	009000166
10	14,3	25	12,9	5	009000167
11	16,0	25	14,3	5	009000168
12	17,4	25	16,0	5	009000169
13	18,0	25	16,4	5	009000170
14	19,3	25	17,9	5	009000171



900MB/SB12		
4-5-5,5-6-7-8-9-10	1	009000179
11-12-13-14 mm		

900L

hexagon hand sockets, long series



UNI/ISO 2725 DIN 3124

⊕	Ø	L	Ø1		
mm	mm	mm	mm		
4	6,5	50	12,0	5	009000181
4,5	7,0	50	12,0	5	009000182
5	7,5	50	12,0	5	009000183
5,5	8,5	50	12,0	5	009000184
6	9,5	50	12,0	5	009000185
7	10,5	50	12,0	5	009000186
8	12,0	50	12,0	5	009000187
9	13,0	50	13,0	5	009000188
10	14,0	50	14,0	5	009000189
11	16,0	50	16,0	5	009000190
12	17,5	50	17,5	5	009000191
13	17,5	50	17,5	5	009000192
14	20,0	50	20,0	5	009000193



900L/SB13		
4-4,5-5-5,5-6-7-8-9-10-11-12-13-14 mm	1	009000203

900MB/L

bi-hex hand sockets, long series



UNI/ISO 2725 DIN 3124

⊕	Ø	L	Ø1		
mm	mm	mm	mm		
5	8,0	50	12,0	3	009000211
6	9,3	50	12,0	3	009000212
7	10,9	50	12,0	3	009000213
8	11,6	50	12,0	3	009000214
9	13,0	50	12,0	3	009000215
10	14,3	50	12,8	3	009000216
11	16,0	50	14,2	3	009000217
12	17,4	50	15,5	3	009000218
13	18,0	50	16,2	3	009000219
14	19,0	50	17,1	3	009000220

900AS

hexagon hand sockets



⊕	Ø	L	Ø1		
mm	mm	mm	mm		
5/32	8,8	25	11,9	5	009000349
3/16	7,7	25	11,9	5	009000340
7/32	8,8	25	11,9	5	009000345
1/4	9,6	25	11,9	5	009000350
9/32	10,2	25	11,9	5	009000355
5/16	11,3	25	11,9	5	009000360
11/32	12,7	25	11,6	5	009000365
3/8	14,0	25	12,9	5	009000370
7/16	15,3	25	14,5	5	009000375
1/2	17,5	25	16,4	5	009000380
9/16	19,0	25	17,9	5	009000385



900AS/SB11		
3/16-7/32-5/32-1/4-9/32-5/16-11/32-3/8-7/16-1/2-9/16	1	009000389

900AS/MB

bi-hex hand sockets



SAE AS 954E

⊕	Ø	L	Ø1		
mm	mm	mm	mm		
3/16	7,7	22	10,9	2	009000390
7/32	8,5	22	10,9	2	009000391
1/4	9,4	22	10,9	2	009000392
9/32	10,2	22	10,9	2	009000393
5/16	11,3	22	11,7	2	009000394
11/32	12,5	22	12,0	2	009000395
3/8	13,7	22	12,9	2	009000396
7/16	15,6	22	14,3	2	009000397
1/2	17,2	22	16,4	2	009000398
9/16	18,8	24	17,9	2	009000399

900AS/L

hexagon hand sockets, long series

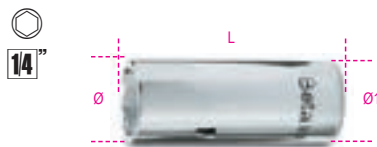

SAE AS 954E

Size	Ø mm	L mm	Ø1 mm	Qty	Part No.
3/16	7,0	50	12,0	2	009000301
7/32	8,5	50	12,0	2	009000303
1/4	9,8	50	12,0	2	009000305
9/32	10,5	50	12,0	2	009000307
5/16	12,0	50	12,0	2	009000309
11/32	13,0	50	13,0	2	009000311
3/8	14,0	50	14,0	2	009000313
7/16	16,0	50	16,0	2	009000315
1/2	17,5	50	17,5	2	009000317
9/16	20,0	50	20,0	2	009000319

900AS/MBL

bi-hex hand sockets, long series



Size	Ø mm	L mm	Ø1 mm	Qty	Part No.
5/32	6,8	50	12,0	2	009000325
3/16	8,0	50	12,0	2	009000326
7/32	8,5	50	12,0	2	009000327
1/4	9,8	50	12,0	2	009000328
9/32	10,9	50	12,0	2	009000329
5/16	11,6	50	12,0	2	009000330
11/32	13,0	50	12,0	2	009000331
3/8	14,3	50	12,8	2	009000332
7/16	16,0	50	14,2	2	009000333
1/2	18,0	50	16,2	2	009000334
9/16	19,0	50	17,1	2	009000335

900FTX

hand sockets for Torx® head screws

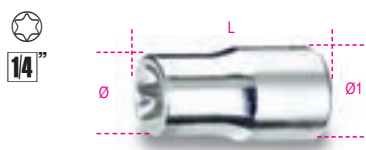

Size	Ø mm	L mm	Ø1 mm	Qty	Part No.
E4	5,4	22	11,2	5	009000404
E5	6,7	22	11,2	5	009000405
E6	7,7	22	11,2	5	009000406
E7	8,3	22	11,2	5	009000407
E8	9,6	22	11,2	5	009000408
E10	11,3	22	12,0	5	009000410
E11	12,1	22	12,5	5	009000411
E12	12,9	23	12,9	5	009000412
E14	14,0	25	14,0	5	009000414



900FTX/SB9
E4-E5-E6-E7-E8
E10-E11-E12-E14
1 009000419

900LP

socket drivers for slotted head screws



Size	Ø mm	L mm	L1 mm	Qty	Part No.
0,8x4	12	28	9	5	009000605
1x5,5	12	28	9	5	009000610
1,2x6,5	12	28	9	5	009000615
1,2x8	13	28	8	5	009000620
1,6x10	14	28	8	5	009000625

900PH

socket drivers for cross head Phillips® screws



PH	Ø mm	L mm	L1 mm	Qty	Part No.
1	12	28	12	5	009000701
2	12	28	12	5	009000702
3	12	28	12	5	009000703
4	13	28	11	5	009000704



900PH/SB4
PH1-PH2-PH3-PH4
1 009000708

900ME

socket drivers for hexagon screws



mm	Ø mm	L mm	L1 mm	Qty	Part No.
2,5	12	25	4,5	5	009000502
3	12	25	5,0	5	009000503
4	12	25	5,6	5	009000504
5	12	25	6,3	5	009000505
6	12	25	7,6	5	009000506
7	13	25	7,2	5	009000507
8	13	25	8,0	5	009000508
10	13	25	8,7	5	009000510



900ME/SB8
2,5-3-4-5-6-7-8-10 mm
1 009000518

900PT

socket drivers for 5-star head screws



Size	Ø mm	L mm	L1 mm	Qty	Part No.
PT10	12	28	12	5	009000750
PT15	12	28	12	5	009000755
PT20	12	28	12	5	009000760
PT25	12	28	12	5	009000765
PT27	12	28	12	5	009000767
PT30	12	28	12	5	009000770

900TX

socket drivers for Torx® head screws



Size	Ø mm	L mm	L1 mm	Qty	Part No.
T8	12	28	12	5	009000719
T9	12	28	12	5	009000720
T10	12	28	12	5	009000721
T15	12	28	12	5	009000722
T20	12	28	12	5	009000723
T25	12	28	12	5	009000724
T27	12	28	12	5	009000725
T30	12	28	12	5	009000726
T40	12	28	12	5	009000727



900TX/SB8
T9-T10-T15-T20
T25-T27-T30-T40
1 009000730

900/16

adaptor, 1/4" female and 3/8" male drives



UNI/ISO 3316 DIN 3123

L mm	Ø mm	Female	Male	Qty	Part No.
28	13,0	1/4	3/8	5	009000814

900/...

1/4" female and male drive extension bars

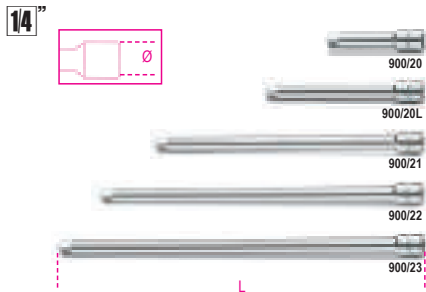

UNI/ISO 3316 DIN 3123

	L mm	Ø mm	
900/20	50	11,5	5 009000818
900/20L	100	11,5	5 009000819
900/21	150	11,5	5 009000822
900/22	250	11,5	5 009000823
900/23	350	11,5	5 009000824

900AN

1/4" wobble extension bars

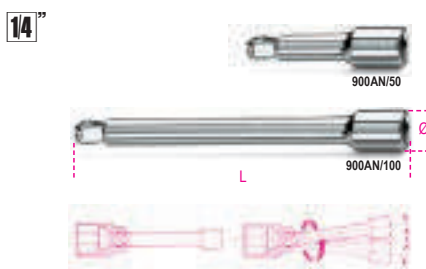

	L mm	Ø mm	
900AN/50	50	11,5	3 009000825
900AN/100	100	11,5	3 009000826

900FL

1/4" flexible universal extension bar



	L mm	Ø mm	
	150	12	3 009000828

900/25

1/4" drive universal joint



UNI/ISO 3316 DIN 3123

	L mm	Ø mm	
	41	12,5	5 009000830

900BG/30C

1/4" drive spinner handle



UNI/ISO 3315 DIN 3122

L mm	L1 mm	
128	20	5 009000833

900BG/30

1/4" drive spinner handle



UNI/ISO 3315 DIN 3122

L mm	L1 mm	
176	68	5 009000834

900/32

1/4" drive flexible handle



L mm	L1 mm	
280	154	2 009000839

900/35A

1/4" drive swivel handle



UNI/ISO 3315 DIN 3122

L mm	L1 mm	
148	84	5 009000840

900M/35

1/4" swivel drive with metal handle



UNI/ISO 3315
DIN 3122

L mm		
130		3 009000845

900/40

1/4" drive swivel T-handle



L mm	L1 mm	
390	145	3 009000843

900/42

1/4" drive sliding T-handle



UNI/ISO 3315 DIN 3122

L mm	A mm	
115	22	5 009000854

900T/44

1/4" male drive, bent, with high torque handle



L mm	L1 mm	
238	105	2 009000860

900/55

1/4" drive reversible ratchet, 48 teeth



UNI/ISO 3315 DIN 3122

L mm	Ø mm	A mm	
125	25	18	5 009000870

900M/55

1/4" drive reversible ratchet with metal handle



UNI/ISO 3315
DIN 3122

L mm	Ø mm	A mm	
110	22	18	3 009000905

Spare parts
rotating mechanism of ratchets,
see table after item 929/C8

900/58

1/4" drive reversible ratchet
with rotating handle,
52 tooth mechanism

- Socket release button
- Ring nut reversal system on ratchet head
- Bi-material handle



L	Ø	A	
mm	mm	mm	
126	28	28,5	2 009000884

900/C39

11 hexagon sockets, 21 bits and 7 accessories



900/C39 1 009000937

	861LP	0,6x4,5 - 1,2x6,5 - 1,2x8 mm
	861PH	PH1-PH2-PH3
	861PZ	PZ1-PZ2-PZ3
	861PE	2,5-3-4-5-6 mm
	861RTX	T10-T15-T20-T25-T27-T30-T40
	900	5-5,5-6-7-8-9-10-11-12-13-14 mm
	900/20	50 mm
	900/20L	100 mm
	900/25	
	900BG/30C	
	900/55	
	892/0	
	895/1	

900/C11

11 hexagon sockets, 20 bits
and 8 accessories



900/C11 1 009000971

	861LP	0,5x3 - 0,8x5,5 1x5,5 - 1,2x6,5 mm
	861PE	3 - 4 - 5 - 6 - 8 mm
	861PH	0 - 1 - 2 - 3
	861TX	T8 - T10 - T15 - T20 T25 - T30 - T40
	895/1	
	900	5 - 5,5 - 6 - 7 - 8 - 9 - 10 11 - 12 - 13 - 14 mm
	900/16	□ 1/4 - ■ 3/8
	900/20	50 mm
	900/21	150 mm
	900/25	
	900BG/30	
	900/42	
	900/55	

270x120x45 mm - 1,2 kg

900/C13-5

13 hexagon sockets and 5 accessories



900/C13-5 1 009000953

	900	4 - 4,5 - 5 - 5,5 - 6 - 7 - 8 - 9 10 - 11 - 12 - 13 - 14 mm
	900/21	150 mm
	900/25	
	900BG/30	
	900/42	
	900/55	

270x120x45 mm - 1 kg

900/C13-8

13 hexagon sockets and 8 accessories



900/C13-8 1 009000954

	900	4 - 4,5 - 5 - 5,5 - 6 - 7 - 8 - 9 10 - 11 - 12 - 13 - 14 mm
	900/16	□ 1/4 - ■ 3/8
	900/20	50 mm
	900/21	150 mm
	900/25	
	900BG/30	
	900/35A	
	900/42	
	900/55	

270x120x45 mm - 1,1 kg

900MB/C19

11 bi-hex sockets and 8 accessories



900MB/C19 1 009000977

	900MB	5 - 5,5 - 6 - 7 - 8 - 9 - 10 - 11 12 - 13 - 14 mm
	900/16	□ 1/4 - ■ 3/8
	900/20	50 mm
	900/21	150 mm
	900/25	
	900BG/30	
	900/35A	
	900/42	
	900/55	

270x120x45 mm - 1,1 kg

900/C24

13 hexagon sockets, 11 socket drivers and 6 accessories

1/4"



900/C24

1 009000956

	○ 900	4 - 4,5 - 5 - 5,5 - 6 - 7 - 8 - 9 10 - 11 - 12 - 13 - 14 mm
	● 900LP	0,8x4 - 1,2x6,5 - 1,2x8 mm
	⊕ 900PH	PH1 - PH2 - PH3
	○ 900ME	3 - 4 - 5 - 6 - 8 mm
	900/20	50 mm
	900/21	150 mm
	900/25	
	900BG/30	
	900/42	
	⊕ 900/55	
≡ 270x120x45 mm - 1,1 kg		

900MB/C28

11 bi-hex sockets, 11 socket drivers and 6 accessories

1/4"



900MB/C28

1 009000979

	○ 900MB	5 - 5,5 - 6 - 7 - 8 - 9 - 10 - 11 12 - 13 - 14 mm
	● 900LP	0,8x4 - 1,2x6,5 - 1,2x8 mm
	⊕ 900PH	PH1 - PH2 - PH3
	○ 900ME	3 - 4 - 5 - 6 - 8 mm
	900/20	50 mm
	900/21	150 mm
	900/25	
	900BG/30	
	900/42	
	⊕ 900/55	
≡ 270x120x45 mm - 1,1 kg		

900AS/C10 - /MB-C17

10 sockets and 7 accessories

1/4"



900AS/C10

1 009000961

	○ 900AS	3/16 - 7/32 - 1/4 - 9/32 - 5/16 11/32 - 3/8 - 7/16 - 1/2 - 9/16
	900/20	50 mm
	900/21	150 mm
	900/25	
	900BG/30	
	900/35A	
	900/42	
	⊕ 900/55	
≡ 270x120x45 mm - 1,1 kg		

900AS/MB-C17

1 009000981

	○ 900AS/MB	3/16 - 7/32 - 1/4 - 9/32 - 5/16 11/32 - 3/8 - 7/16 - 1/2 - 9/16
	900/20	50 mm
	900/21	150 mm
	900/25	
	900BG/30	
	900/35A	
	900/42	
	⊕ 900/55	
≡ 270x120x45 mm - 1,1 kg		

900AS/C17-MBM

10 bi-hex sockets and 7 accessories for aeronautical maintenance

1/4"



900AS/C17-MBM

1 009000982

	○ 900AS/MB	3/16 - 7/32 - 1/4 - 9/32 - 5/16 11/32 - 3/8 - 7/16 - 1/2 - 9/16
	900/20	50 mm
	900/21	150 mm
	900/25	
	900BG/30	
	900M/35	
	900/42	
	900M/55	
≡ 270x120x45 mm - 1,2 kg		

900/C11HR

11 hexagon sockets, 20 bits and 7 accessories in hard foam tray, in metal case

• ratchet with rotating handle

1/4"

1/4"



900/C11HR

1 009000980

	● 861LP	0,5x3-0,8x5,5-1x5,5-1,2x6,5 mm
	⊕ 861PH	PH0-PH1-PH2-PH3
	○ 861PE	3-4-5-6-8 mm
	⊕ 861TX	T8-T10-T15-T20-T25-T30-T40
	895/1	
	○ 900	5-5,5-6-7-8-9-10-11-12-13-14 mm
	900/16	□ 1/4 - ■ 3/8
	900/20	50 mm
	900/21	150 mm
	900/25	
	900/42	
	900/30	
	900/58	
≡ 350x150x50 mm - 1,3 kg		

902R/C6

6 adaptors for socket drivers



902R/C6

1 009020814

	900/16	□ 1/4 - ■ 3/8
	910/15	□ 3/8 - ■ 1/4
	910/16	□ 3/8 - ■ 1/2
	920/15	□ 1/2 - ■ 3/8
	920/16	□ 1/2 - ■ 3/4
	928/15	□ 3/4 - ■ 1/2
≡ 170x100x35 mm - 600 g		

910A

hexagon hand sockets

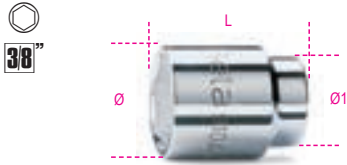

UNI/ISO 2725 DIN 3124

mm	Ø	L	Ø1		
6	9,5	28	16,7	5	009100006
7	10,7	28	16,7	5	009100007
8	12,1	28	16,7	5	009100008
9	13,2	28	16,7	5	009100009
10	14,6	29	16,7	5	009100010
11	15,8	29	16,7	5	009100011
12	17,2	30	17,7	5	009100012
13	18,4	31	17,0	5	009100013
14	19,7	32	17,5	5	009100014
15	20,9	32	18,0	5	009100015
16	22,2	33	18,5	5	009100016
17	23,2	33	19,0	5	009100017
18	24,7	34	20,0	5	009100018
19	25,8	35	21,0	5	009100019
20	27,2	35	22,0	5	009100020
21	28,2	36	23,0	5	009100021
22	29,7	37	24,0	5	009100022

910AL

hexagon hand sockets,
long series

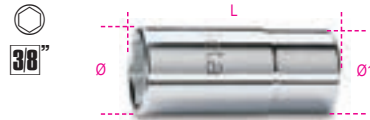

UNI/ISO 2725 DIN 3124

mm	Ø	L	Ø1		
8	12,0	55	17	3	009100158
9	13,0	55	17	3	009100159
10	14,5	55	17	3	009100160
11	16,0	55	17	3	009100161
12	17,0	55	17	3	009100162
13	18,0	55	17	3	009100163
14	20,0	55	18	3	009100164
15	21,0	55	20	3	009100165
16	22,0	55	20	3	009100166
17	23,5	55	22	3	009100167
18	24,5	55	23	2	009100168
19	25,0	55	24	2	009100169
21	27,0	65	26	2	009100171
22	29,0	65	28	2	009100172

910B/SN

swivel end bi-hex hand sockets



mm	Ø	L	Ø1		
10	14,5	48,5	19	2	009100230
11	15,8	49,5	19	2	009100231
12	17,0	50,0	19	2	009100232
13	18,3	51,0	19	2	009100233
14	19,5	51,0	19	2	009100234
15	20,8	53,5	19	2	009100235
16	22,0	53,5	19	2	009100236
17	23,3	54,5	19	2	009100237
18	24,5	54,5	19	2	009100238
19	25,8	56,5	19	2	009100239



910A/SB17

6-7-8-9-10-11-12
13-14-15-16-17
18-19-20-21-22 mm

1 009100030



910AL/SB14

8-9-10-11-12-13-14
15-16-17-18-19-21-22 mm

1 009100174

910B

bi-hex hand sockets



UNI/ISO 2725 DIN 3124

mm	Ø	L	Ø1		
6	9,5	28	16,7	5	009100106
7	10,7	28	16,7	5	009100107
8	12,1	28	16,7	5	009100108
9	13,2	28	16,7	5	009100109
10	14,6	29	16,7	5	009100110
11	15,8	29	16,7	5	009100111
12	17,2	30	17,7	5	009100112
13	18,4	31	17,0	5	009100113
14	19,7	32	17,5	5	009100114
15	20,9	32	18,0	5	009100115
16	22,2	33	18,5	5	009100116
17	23,2	33	19,0	5	009100117
18	24,7	34	20,0	5	009100118
19	25,8	35	21,0	5	009100119
20	27,2	35	22,0	5	009100120
21	28,2	36	23,0	5	009100121
22	29,7	37	24,0	5	009100122

910BL

bi-hex hand sockets, long series

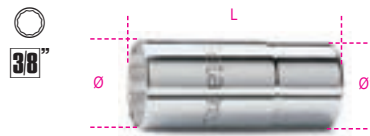

UNI/ISO 2725 DIN 3124

mm	Ø	L	Ø1		
8	12,0	55	17	3	009100308
9	13,0	55	17	3	009100309
10	14,5	55	17	3	009100310
11	16,0	55	17	3	009100311
12	17,0	55	17	3	009100312
13	18,0	55	17	3	009100313
14	20,0	55	18	3	009100314
15	21,0	55	20	3	009100315
16	22,0	55	20	3	009100316
17	23,5	55	22	3	009100317
18	24,5	55	23	2	009100318
19	25,0	55	24	2	009100319
21	27,0	65	26	2	009100321
22	29,0	65	28	2	009100322

910A/AS

hexagon hand sockets

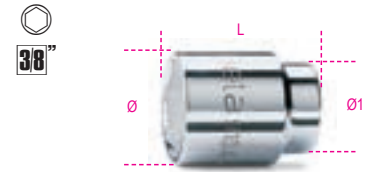

"	Ø	L	Ø1		
1/4	10,3	26	17,3	5	009100276
5/16	11,9	26	17,3	5	009100278
11/32	13,3	26	17,3	5	009100279
3/8	13,9	26	17,3	5	009100280
7/16	15,8	26	17,3	5	009100281
1/2	17,9	26	17,3	5	009100283
9/16	19,5	27	18,5	5	009100284
19/32	20,6	27	19,5	5	009100285
5/8	21,9	28	20,0	5	009100286
11/16	24,6	30	22,5	5	009100287
3/4	25,9	30	23,5	5	009100289
13/16	27,9	32	26,0	5	009100291
7/8	29,6	32	26,5	5	009100292



910B/SB17

6-7-8-9-10-11-12
13-14-15-16-17
18-19-20-21-22 mm

1 009100130



910BL/SB14

8-9-10-11-12-13
14-15-16-17-18
19-21-22 mm

1 009100340



910A-AS/SB13

1/4-5/16-11/32-3/8-7/16
1/2-9/16-19/32-5/8-11/16
3/4-13/16-7/8

1 009100295



910AS

bi-hex hand sockets

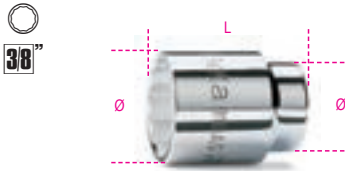

Size	Ø mm	L mm	Ø1 mm	Qty	Part No.
1/4	9,5	28	16,7	5	009100201
5/16	12,1	28	16,7	5	009100202
11/32	13,2	28	16,7	5	009100203
3/8	14,6	29	16,7	5	009100204
7/16	15,8	29	16,7	5	009100205
1/2	18,4	31	17,0	5	009100206
9/16	19,7	32	17,5	5	009100207
19/32	20,9	32	18,0	5	009100208
5/8	22,2	33	18,5	5	009100209
11/16	24,7	34	20,0	5	009100210
3/4	25,8	35	21,0	5	009100211
13/16	28,2	36	23,0	5	009100212
7/8	29,7	37	24,0	5	009100213



910AS/SB13	1	009100215
1/4-5/16-11/32-3/8-7/16		
1/2-9/16-19/32-5/8-11/16		
3/4-13/16-7/8		

910AS/L

bi-hex hand sockets, long series

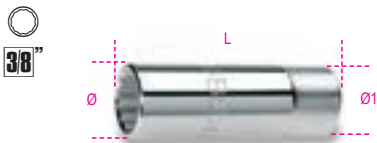

Size	Ø mm	L mm	Ø1 mm	Qty	Part No.
1/4	10	55	17	3	009100350
5/16	12	55	17	3	009100351
3/8	14	55	17	3	009100352
7/16	16	55	17	3	009100353
1/2	18	55	17	3	009100354
9/16	20	55	18	3	009100355
19/32	21	55	20	3	009100356
5/8	22	55	20	3	009100357
11/16	23	55	22	3	009100359
3/4	25	55	24	3	009100360
13/16	27	65	26	3	009100362
7/8	29	65	28	3	009100363



910ASL/SB12	1	009100365
1/4-5/16-3/8-7/16		
1/2-9/16-19/32-5/8-11/16		
3/4-13/16-7/8		

910AS/SN

swivel end bi-hex hand sockets

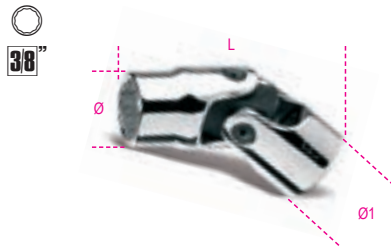

* SAE AS 954E

Size	Ø mm	L mm	Ø1 mm	Qty	Part No.
* 3/8	14,0	48,0	19	2	009100260
* 7/16	15,8	51,0	19	2	009100261
* 1/2	18,3	51,0	19	2	009100262
* 9/16	19,5	51,0	19	2	009100263
* 5/8	22,0	53,5	19	2	009100264
11/16	24,5	54,5	19	2	009100265
3/4	25,8	56,5	19	2	009100266

910FTX

hand sockets for Torx® head screws

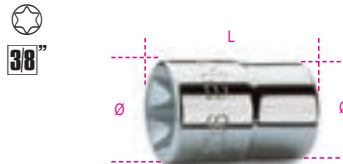

Size	Ø mm	L mm	Ø1 mm	Qty	Part No.
E4	6,2	26	17,3	5	009100404
E5	7,0	26	17,3	5	009100405
E6	8,3	26	17,3	5	009100406
E7	8,9	26	17,3	5	009100407
E8	9,9	26	17,3	5	009100408
E10	12,0	26	17,3	5	009100410
E12	14,5	26	17,3	5	009100412
E14	15,8	26	17,3	5	009100414
E16	18,0	26	17,3	5	009100416



910FTX/SB9	1	009100430
E4-E5-E6-E7-E8		
E10-E12-14-E16		

910FTX/L

hand sockets for Torx® head screws, long series



Size	Ø mm	L mm	Ø1 mm	Qty	Part No.
E4	6,2	55	17,3	3	009100440
E5	7,0	55	17,3	3	009100441
E6	8,3	55	17,3	3	009100442
E7	8,9	55	17,3	3	009100443
E8	9,9	55	17,3	3	009100444
E10	12,0	55	17,3	3	009100445



910FTX-L/SB6	1	009100449
E4-E5-E6		
E7-E8-E10		

910LP

socket drivers for slotted head screws

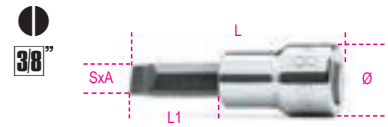

Size	SxA mm	Ø mm	L mm	L1 mm	Qty	Part No.
1x5,5	18,5	18,5	54	24	2	009100452
1,2x6,5	18,5	18,5	54	24	2	009100453
1,2x8	18,5	18,5	54	24	2	009100454
1,6x9	18,5	18,5	54	24	2	009100456

910PH

socket drivers for cross head Phillips® screws



PH	Ø mm	L mm	L1 mm	Qty	Part No.
1	18,5	48	18	2	009100471
2	18,5	48	18	2	009100472
3	18,5	48	18	2	009100473
4	18,5	48	18	2	009100474



910PH/SB4	1	009100478
PH1-PH2-PH3-PH4		

910PE

socket drivers for hexagon screws

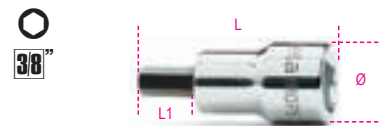

DIN 7422

mm	Ø mm	L mm	L1 mm	Qty	Part No.
3	18,5	50	20	5	009100490
4	18,5	50	20	5	009100492
5	18,5	50	20	5	009100494
6	18,5	50	20	5	009100496
7	18,5	50	20	5	009100497
8	18,5	50	20	5	009100498
10	18,5	50	20	5	009100500



910PE/SB7	1	009100503
3-4-5-6-7-8-10 mm		

910BP

ball head socket drivers
for hexagon screws



mm	L mm	L1 mm		
4L	92	62	3	009100584
5L	92	62	3	009100585
6L	92	62	3	009100586
7L	92	62	3	009100587
8L	92	62	3	009100588
10L	132	102	3	009100590



910BP/SB6L
4L-5L-6L-7L-8L-10L mm

910ME

socket drivers for hexagon screws



mm	Ø mm	L mm	L1 mm		
4	18	62	15	5	009100504
5	18	62	15	5	009100505
6	18	62	15	5	009100506
7	18	62	15	5	009100507
8	19	62	15	5	009100508
10	20	62	15	5	009100510
12	20	62	15	5	009100512



910ME/SB5
4-5-6-8-10 mm

910PT

socket drivers for 5-star head screws



PT	Ø mm	L mm	L1 mm		
PT40	20	50	20	3	009100540
PT45	20	50	20	3	009100545
PT50	20	50	20	3	009100550

1/4"



3/8"

910PT/SB8
PT10-PT15-PT20-PT25
PT30-PT40-PT45-PT50

910TX

socket drivers for Torx® head screws

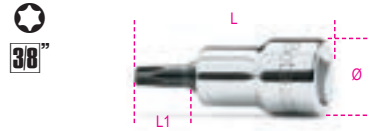

TX	Ø mm	L mm	L1 mm		
T15	18,5	50	20	5	009100519
T20	18,5	50	20	5	009100520
T25	18,5	50	20	5	009100521
T27	18,5	50	20	5	009100522
T30	18,5	50	20	5	009100523
T40	18,5	50	20	5	009100524



910TX/SB6
T15-T20-T25
T27-T30-T40

910CF

3/8" square drive crowfoot wrenches



CF	A mm	L mm		
10	21,3	32,3	2	009100135
11	23,1	34,3	2	009100136
12	25,5	36,2	2	009100137
13	26,9	37,4	2	009100138
14	30,2	40,0	2	009100139
15	33,3	41,3	2	009100140
16	33,3	41,3	2	009100141
17	38,1	46,5	2	009100142
18	38,1	46,5	2	009100143
19	39,6	48,0	2	009100144



910CF/SB10
10-11-12-13-14-15
16-17-18-19 mm

910/15

adaptor, 3/8" female
and 1/4" male drivers



UNI/ISO 3316 DIN 3123

L mm	Ø mm	3/8"	1/4"		
30	17,0	3/8	1/4	5	009100810



Always apply torque loads evenly
and progressively to avoid breakage
and any possible injury.

910/16

adaptor, 3/8" female
and 1/2" male drives



UNI/ISO 3316 DIN 3123

L mm	Ø mm	3/8"	1/2"		
32	18,0	3/8	1/2	5	009100814

910/20 - 910/21 - 910/22

3/8" drive extension bars

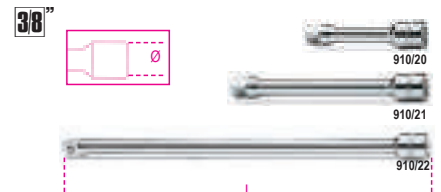

UNI/ISO 3316 DIN 3123

	L mm	Ø mm		
910/20	75	17	5	009100820
910/21	125	17	5	009100822
910/22	250	17	5	009100826

Beta

910AN

3/8" wobble extension bars

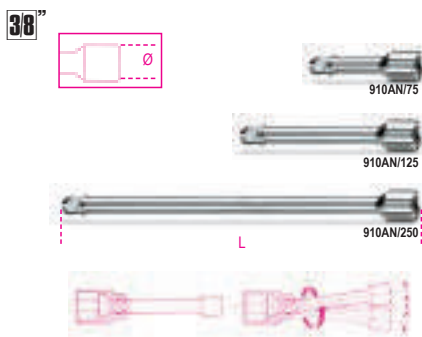

	L mm	Ø mm	
910AN/75	75	17	3 009100827
910AN/125	125	17	3 009100828
910AN/250	250	17	3 009100829

910/25

3/8" drive universal joint



UNI/ISO 3316 DIN 3123

L mm	Ø mm	
54,6	19	5 009100830

910M/35

3/8" swivel drive with metal handle



UNI/ISO 3315 DIN 3122

L mm		
250		3 009100839

910/36A

3/8" drive swivel handle



UNI/ISO 3315 DIN 3122

L mm	L1 mm	
255	154	3 009100845

910/40

3/8" drive swivel T-handle



L mm	L1 mm	
420	175	3 009100850

910/42

3/8" drive sliding T-handle

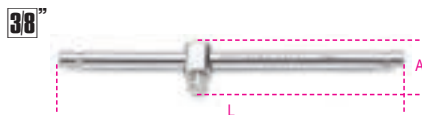

UNI/ISO 3315 DIN 3122

L mm	A mm	
210	30,5	5 009100854

910/46

3/8" square drive with speed brace

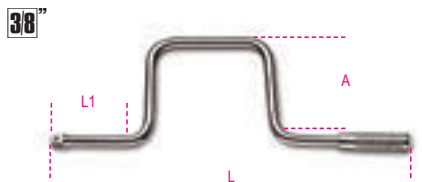

UNI/ISO 3315 DIN 3122

L mm	L1 mm	A mm	
315	80	115	1 009100862

910/55

3/8" drive reversible ratchet 72 teeth



UNI/ISO 3315 DIN 3122

L mm	Ø mm	A mm	
200	30	33	3 009100882

910/55Q

3/8" drive reversible ratchet 48 teeth



UNI/ISO 3315 DIN 3122

L mm	Ø mm	A mm	
200	30	33	3 009100885

910M/55

3/8" drive reversible ratchet with metal handle



DIN 3122 - UNI ISO 3315

L mm	Ø mm	A mm	
178	30	26	2 009100875

910M/56

3/8" drive reversible swivel ratchet with metal handle



L mm	Ø mm	A mm	
265	31	29	2 009100887

910/58

3/8" drive reversible ratchet with rotating handle, 52 tooth mechanism

- Socket release button
- Ring nut reversal system on ratchet head
- Bi-material handle



L mm	Ø mm	A mm	
222	37	38,5	1 009100884

910.../C10

10 sockets and 2 accessories



910A/C10	
	1 009100909

910A	6 - 7 - 8 - 10 - 11 - 12 13 - 14 - 17 - 19 mm
910/21	125 mm
910/55	

270x120x45 mm - 1,3 kg

Spare parts
rotating mechanism of ratchets,
see table after item 929/C8

910B/C10 1 009100910

- 910B 6 - 7 - 8 - 10 - 11 - 12
13 - 14 - 17 - 19 mm
- 910/21 125 mm
- 910/55
- ≡ 270x120x45 mm - 1,3 kg

910A/C16...
16 hexagon sockets and 5 accessories



910A/C16 1 009100936

- 910A 6 - 7 - 8 - 9 - 10 - 11 - 12 - 13
14 - 15 - 16 - 17 - 18 - 19
21 - 22 mm
- 910/21 125 mm
- 910/22 250 mm
- 910/25
- 910/42
- 910/55
- ≡ 335x145x60 mm - 2,3 kg

910A/C16Q 1 009100932

- 910A 6 - 7 - 8 - 9 - 10 - 11 - 12 - 13
14 - 15 - 16 - 17 - 18 - 19
21 - 22 mm
- 910/21 125 mm
- 910/22 250 mm
- 910/25
- 910/42
- 910/55Q
- ≡ 335x145x60 mm - 2,3 kg

910B/C16...
16 bi-hex sockets and 5 accessories



910B/C16 1 009100937

- 910B 6 - 7 - 8 - 9 - 10 - 11 - 12 - 13
14 - 15 - 16 - 17 - 18 - 19
21 - 22 mm
- 910/21 125 mm
- 910/22 250 mm
- 910/25
- 910/42
- 910/55
- ≡ 335x145x60 mm - 2,3 kg

910B/C16Q 1 009100933

- 910B 6 - 7 - 8 - 9 - 10 - 11 - 12 - 13
14 - 15 - 16 - 17 - 18 - 19
21 - 22 mm
- 910/21 125 mm
- 910/22 250 mm
- 910/25
- 910/42
- 910/55Q
- ≡ 335x145x60 mm - 2,3 kg

910A/C17
17 hexagon sockets and 9 accessories



910A/C17 1 009100938

- 910A 6 - 7 - 8 - 9 - 10 - 11 - 12 - 13
14 - 15 - 16 - 17 - 18 - 19 - 20
21 - 22 mm
- 910/15 □ 3/8 - ■ 1/4
- 910/16 □ 3/8 - ■ 1/2
- 910/21 125 mm
- 910/22 250 mm
- 910/25
- 910/36A
- 910/42
- 910/46
- 910/55
- ≡ 420x280x60 mm - 4,0 kg

910.../C29
17 sockets, 12 socket drivers
and 5 accessories



910A/C29 1 009100944

- 910A 6 - 7 - 8 - 9 - 10 - 11 - 12 - 13
14 - 15 - 16 - 17 - 18 - 19 - 20
21 - 22 mm
- 910LP 1x5,5 - 1,2x6,5 - 1,2x8 mm
- 910PH PH1 - PH2 - PH3
- 910PE 3 - 4 - 5 - 6 - 8 - 10 mm
- 910/21 125 mm
- 910/22 250 mm
- 910/25
- 910/42
- 910/55
- ≡ 420x185x60 mm - 3,5 kg

910B/C29 1 009100945

- 910B 6 - 7 - 8 - 9 - 10 - 11 - 12 - 13
14 - 15 - 16 - 17 - 18 - 19 - 20
21 - 22 mm
- 910LP 1x5,5 - 1,2x6,5 - 1,2x8 mm
- 910PH PH1 - PH2 - PH3
- 910PE 3 - 4 - 5 - 6 - 8 - 10 mm
- 910/21 125 mm
- 910/22 250 mm
- 910/25
- 910/42
- 910/55
- ≡ 420x185x60 mm - 3,5 kg

910AS/C13...
13 bi-hex sockets and 5 accessories



910AS/C13 1 009100925

- 910AS 1/4 - 5/16 - 11/32 - 3/8 - 7/16
1/2 - 9/16 - 19/32 - 5/8 - 11/16
3/4 - 13/16 - 7/8
- 910/21 125 mm
- 910/22 250 mm
- 910/42
- 910/25
- 910/55
- ≡ 335x145x60 mm - 2,3 kg



910AS/MBM-C18

13 bi-hex sockets and 5 accessories
for aeronautical maintenance

38"



910AS/MBM-C18

1 009100926

	○ 910AS	1/4 - 5/16 - 11/32 - 3/8 - 7/16 1/2 - 9/16 - 19/32 - 5/8 - 11/16 3/4 - 13/16 - 7/8
	910/21	125 mm
	910/22	250 mm
	910/25	
	910/42	
	910M/55	
	335x145x60 mm	- 2,5 kg

910A/C16HR

16 hexagon sockets and 5 accessories

38"



910A/C16HR

1 009100935

	○ 910A	6 - 7 - 8 - 9 - 10 - 11 - 12 - 13 14 - 15 - 16 - 17 - 18 - 19 21 - 22 mm
	910/21	125 mm
	910/22	250 mm
	910/25	
	910/42	
	910/58	
	335x145x60 mm	- 2,4 kg

920A

hexagon hand sockets

12"



UNI/ISO 2725 DIN 3124

mm	Ø	L	Ø1		
8	12,4	38	21,7	10	009200008
9	13,5	38	21,7	10	009200009
10	14,9	38	21,7	10	009200010
11	16,1	38	21,7	10	009200011
12	17,5	38	21,7	10	009200012
13	18,7	38	21,7	10	009200013
14	20,1	38	21,7	10	009200014
15	21,5	38	22,5	10	009200015
16	22,7	38	23,7	10	009200016
17	24,1	38	23,1	10	009200017
18	25,3	39	24,0	10	009200018
19	26,6	39	24,0	10	009200019
20	27,8	40	25,0	5	009200020
21	28,8	40	25,0	5	009200021
22	29,9	41	26,0	5	009200022
23	30,8	42	26,0	5	009200023
24	32,2	43	27,0	5	009200024
25	33,2	44	27,0	5	009200025
26	34,7	45	28,0	5	009200026
27	36,2	46	29,0	5	009200027
28	37,2	47	30,0	5	009200028
29	38,6	48	31,0	5	009200029
30	40,2	48	32,0	5	009200030
32	42,3	49	34,0	5	009200032

12"



920A/SB13

10-11-12-13-14-15-16
17-18-19-20-21-22 mm

1 009200040

12"



920A/SB8

23-24-25-26-27-28-30-32 mm

1 009200042

920B

bi-hex hand sockets

12"



UNI/ISO 2725 DIN 3124

mm	Ø	L	Ø1		
8	12,4	38	21,7	10	009200108
9	13,5	38	21,7	10	009200109
10	14,9	38	21,7	10	009200110
11	16,1	38	21,7	10	009200111
12	17,5	38	21,7	10	009200112
13	18,7	38	21,7	10	009200113
14	20,1	38	21,7	10	009200114
15	21,5	38	22,5	10	009200115
16	22,7	38	23,7	10	009200116
17	24,1	38	23,1	10	009200117

mm	Ø	L	Ø1		
18	25,3	39	24,0	10	009200118
19	26,6	39	24,0	10	009200119
20	27,8	40	25,0	5	009200120
21	28,8	40	25,0	5	009200121
22	29,9	41	26,0	5	009200122
23	30,8	42	26,0	5	009200123
24	32,2	43	27,0	5	009200124
25	33,2	44	27,0	5	009200125
26	34,7	45	28,0	5	009200126
27	36,2	46	29,0	5	009200127
28	37,2	47	30,0	5	009200128
29	38,6	48	31,0	5	009200129
30	40,2	48	32,0	5	009200130
32	42,3	49	33,9	5	009200132

12"



920B/SB13

10-11-12-13-14-15-16
17-18-19-20-21-22 mm

1 009200140

12"



920B/SB8

23-24-25-26-27
28-30-32 mm

1 009200142

920AL

hexagon hand sockets,
long series

12"



UNI/ISO 2725 DIN 3124

mm	Ø	L	Ø1		
10	14,7	77	21	5	009200626
12	17,8	77	21	5	009200627
13	19,0	77	22	5	009200628
14	20,3	77	22	5	009200629
15	21,5	77	22	5	009200630
16	22,8	77	22	5	009200631
17	24,0	77	23	5	009200632
18	25,0	77	24	5	009200633
19	26,5	77	25	5	009200634
21	29,0	77	27	5	009200635
22	30,0	77	28	5	009200636
23	31,5	77	29	5	009200637
24	32,8	77	30	5	009200638
27	36,5	77	33	3	009200639
30	40,0	77	36	3	009200640
32	42,8	77	38	3	009200641
36	48,0	77	41	3	009200642

12"



920AL/SB11

10-12-13-14-15-16
17-18-19-21-22 mm

1 009200644

Beta

Beta

920BL

bi-hex hand sockets, long series



UNI/ISO 2725 DIN 3124

mm	Ø	L	Ø1		
10	14,7	77	21	5	009200310
12	17,8	77	21	5	009200312
13	19,0	77	22	5	009200313
14	20,3	77	22	5	009200314
15	21,5	77	22	5	009200315
16	22,8	77	22	5	009200316
17	24,0	77	23	5	009200317
18	25,0	77	24	5	009200318
19	26,5	77	25	5	009200319
21	29,0	77	27	5	009200321
22	30,0	77	28	5	009200322
23	31,5	77	29	5	009200323
24	32,8	77	30	5	009200324
27	36,5	77	33	3	009200327
30	40,0	77	36	3	009200330
32	42,8	77	38	3	009200332
36	48,0	77	41	3	009200336



920BL/SB11
10-12-13-14-15-16-17-18
19-21-22 mm

1 009200338

920A/AS

hexagon hand sockets

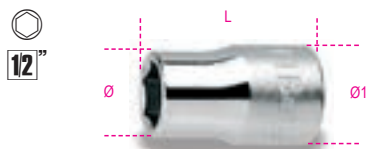

mm	Ø	L	Ø1		
3/8	14,6	37	21	2	009200270
7/16	16,5	37	21	3	009200272
1/2	19,0	37	22	3	009200273
9/16	20,3	37	22	3	009200274
19/32	21,0	37	22	3	009200275
5/8	22,8	37	22	3	009200276
11/16	25,0	37	24	3	009200277
3/4	26,5	38	25	3	009200279
25/32	28,0	38	26	3	009200280
13/16	29,0	38	27	3	009200281
7/8	30,0	40	28	3	009200282
15/16	32,8	42	30	3	009200284
1	35,0	42	32	3	009200285
1.1/16	36,5	43	33	2	009200287
1.1/8	39,0	43	35	2	009200289
1.3/16	41,0	46	36	2	009200290
1.1/4	42,8	46	38	2	009200292



920A-AS/SB11
3/8-7/16-1/2-9/16-5/8
11/16-3/4-13/16-7/8
15/16-1

1 009200295

920AS

bi-hex hand sockets

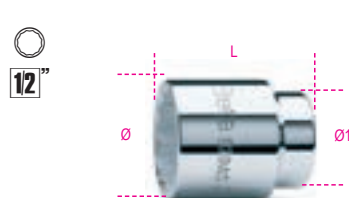

"	Ø	L	Ø1		
3/8	14,9	38	21,7	3	009200201
7/16	16,1	38	21,7	3	009200202
1/2	18,7	38	21,7	3	009200203
9/16	20,1	38	21,7	3	009200204
5/8	22,7	38	22,5	3	009200206
19/32	21,5	38	23,7	3	009200207
11/16	25,3	39	24,0	3	009200208
3/4	26,6	39	24,0	3	009200209
25/32	27,8	40	25,0	3	009200210
13/16	28,8	40	25,0	3	009200211
7/8	29,9	41	26,0	3	009200212
15/16	32,2	43	27,0	3	009200214
1	34,2	45	28,0	3	009200216
1.1/16	36,2	46	29,0	2	009200217
1.1/8	38,6	48	31,0	2	009200218
1.3/16	40,2	48	32,0	2	009200219
1.1/4	42,3	49	33,5	2	009200220



920AS/SB11
3/8-7/16-1/2-9/16-5/8
11/16-3/4-13/16-7/8
15/16-1

1 009200225

920AS/L

bi-hex hand sockets, long series



"	Ø	L	Ø1		
1/2	19,0	77	22	2	009200352
9/16	20,3	77	22	2	009200353
5/8	22,8	77	22	2	009200355
11/16	25,0	77	24	2	009200357
3/4	26,5	77	25	2	009200358
13/16	29,0	77	27	2	009200360
7/8	30,0	77	28	2	009200361
15/16	32,8	77	30	2	009200362
1	35,0	77	32	2	009200363
1.1/16	36,5	77	33,0	2	009200364
1.1/8	37,8	77	34	2	009200365



920ASL/SB11
1/2-9/16-5/8-11/16
3/4-13/16-7/8-15/16
1-1.1/8-1.1/16

1 009200369

920FTX

hand sockets for Torx® head screws



"	Ø	L	Ø1		
E10	13,2	36	21	5	009200380
E12	15,0	37	21	5	009200381
E14	16,3	37	21	5	009200382
E16	18,8	37	22	5	009200383
E18	20,4	37	22	5	009200384
E20	22,9	37	22	5	009200385
E22	25,0	37	24	3	009200387
E24	26,5	40	25	3	009200388



920FTX/SB6
E10-E12-E14
E16-E18-E20

1 009200390



920FTX/C8
E10-E12-E14-E16
E18-E20-E22-E24

270X120X45 mm - 1 kg

1 009200391

920FTX/L

hand sockets for Torx® head screws, long series



"	Ø	L	Ø1		
E10	13,2	77	21,0	5	009200400
E12	15,0	77	21,0	5	009200401
E14	16,3	77	21,0	5	009200402
E16	18,8	77	21,8	3	009200403
E18	20,4	77	21,8	3	009200404
E20	22,9	77	22,0	3	009200405



920FTX-LSB6
E10-E12-E14
E16-E18-E20

1 009200409

920LP

socket drivers for slotted head screws



SxA	Ø	L	L1		
mm	mm	mm	mm		
1x5,5	22,5	62	24	3	009200452
1,2x6,5	22,5	62	24	3	009200453
1,2x8	22,5	62	24	3	009200454
1,6x9	22,5	62	24	3	009200456
2x12	22,5	62	24	3	009200458

920PH

socket drivers for cross head Phillips® screws



PH	Ø	L	L1		
mm	mm	mm	mm		
1	22,5	56	18	3	009200471
2	22,5	56	18	3	009200472
3	22,5	56	18	3	009200473
4	22,5	56	18	3	009200474



920PH/SH4
PH1-PH2-PH3-PH4 1 009200479

920LH/SB7

socket drivers for cross head Phillips® screws



920LH/SB7					
920LP	1,2x6,5 - 1,2x8			1	009200478
920PH	1,6x9 - 2x12 mm				
	PH2 - PH3 - PH4				

920PE

socket drivers for hexagon screws

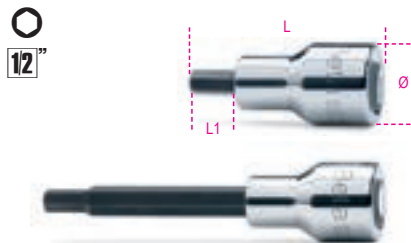

DIN 7422

mm	Ø	L	L1		
mm	mm	mm	mm		
3	22,5	58	20	5	009200410
4	22,5	58	20	5	009200412
5	22,5	58	20	5	009200414
5L	22,5	100	62	5	009200415
6	22,5	58	20	5	009200417
6L	22,5	100	62	5	009200418
7	22,5	58	20	5	009200420
7L	22,5	100	62	5	009200421
8	22,5	58	20	5	009200423
8L	22,5	100	62	5	009200424
9	22,5	58	20	5	009200425
9L	22,5	140	102	5	009200426
10	22,5	58	20	5	009200428
10L	22,5	140	102	5	009200429
12	23,0	58	20	5	009200432
12L	22,5	140	102	5	009200433
14	23,0	58	20	5	009200434
14L	22,5	140	102	5	009200435
17	29,5	60	22	5	009200437
19	29,5	60	22	5	009200439



920PE/SB9
4-5-6-8-10 mm 1 009200441
5L-6L-8L-10L mm



920PE/C10
4-5-6-7-8-10 1 009200443
12-14-17-19 mm
270X120X45 mm - 1,5 kg

920PE/AS

socket drivers for hexagon screws



"	Ø	L	L1		
mm	mm	mm	mm		
1/8	22,5	58	20	2	009200460
3/16	22,5	58	20	2	009200461
1/4	22,5	58	20	2	009200463
3/8	22,5	58	20	2	009200464
1/2	22,5	60	20	2	009200465
3/4	22,5	60	20	1	009200468

12"



920PE-AS/SB6
1/8-3/16-1/4-3/8-1/2-3/4 1 009200469

920BP

ball head socket drivers for hexagon screws

12"

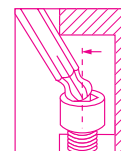
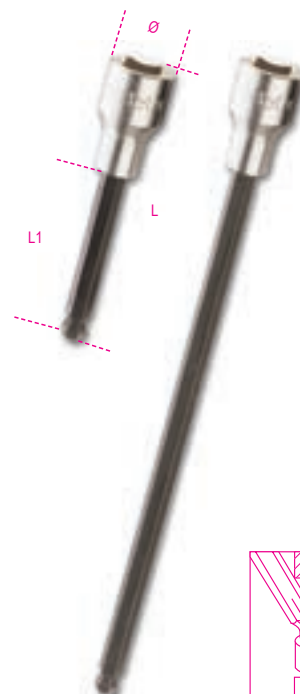

mm	Ø	L	L1		
mm	mm	mm	mm		
5L	22,5	100	62	5	009200490
5XL	22,5	240	202	1	009200495
6L	22,5	100	62	5	009200491
6XL	22,5	240	202	1	009200496
7L	22,5	100	62	5	009200492
8L	22,5	100	62	5	009200493
8XL	22,5	240	202	1	009200497
10L	22,5	140	102	5	009200494

12"



920BP/SB8
5L-6L-7L-8L-10L mm 1 009200500
5XL-6XL-8XL mm

920ME

socket drivers for hexagon screws



mm	Ø mm	L mm	L1 mm	12"	12"
5	21	75	15,5	5	009200505
6	21	75	15,5	5	009200506
7	21	75	15,5	5	009200507
8	21	75	15,5	5	009200508
10	23	75	15,5	5	009200510
12	24	75	15,5	5	009200512
14	24	75	15,5	5	009200514
17	24	75	15,5	5	009200517



920ME/SB7
5-6-8-10-12-14-17 mm



1 009200519



920ME/C7
5-6-8-10-12-14-17 mm



1 009200518

250X100X35 mm - 1,4 kg

920TX

socket drivers for Torx® head screws



Ø mm	L mm	L1 mm	12"	12"
T20	22,5	58	20	5 009200520
T20L	22,5	120	82	3 009200530
T25	22,5	58	20	5 009200521
T25L	22,5	120	82	3 009200531
T27	22,5	58	20	5 009200522
T27L	22,5	120	82	3 009200533
T30	22,5	58	20	5 009200523
T30L	22,5	120	82	3 009200534
T40	22,5	58	20	5 009200524
T40L	22,5	120	82	3 009200535
T45	22,5	58	20	5 009200525
T45L	22,5	120	82	3 009200537
T50	22,5	58	20	5 009200526
T50L	23,0	140	102	3 009200538
T55	23,0	58	20	3 009200527
T55L	23,0	140	102	3 009200539
T60	23,0	58	20	3 009200528
T60L	23,0	140	102	3 009200540
T70L	23,0	120	82	3 009200541



920TX-SB9
T20-T25-T27-T30
T40-T45-T50-T55-T60



1 009200532



920TX-L/SB10

T20L-T25L-T27L-T30L-T40L-
T45L-T50L-T55L-T60L-T70L



1 009200545



920TX/C9

T20-T25-T27-T30-T40
T45-T50-T55-T60



1 009200546

270X120X45 mm - 1,2 kg

920RTX

socket drivers
for Tamper Resistant Torx® head screws



Ø mm	L mm	L1 mm	12"	12"
T20	22,5	58	20	5 009200370
T25	22,5	58	20	5 009200371
T27	22,5	58	20	5 009200372
T30	22,5	58	20	5 009200373
T40	22,5	58	20	5 009200374



920RTX/SB5

T20-T25-T27-T30-T40



1 009200378

920XZN

socket drivers with XZN® profile

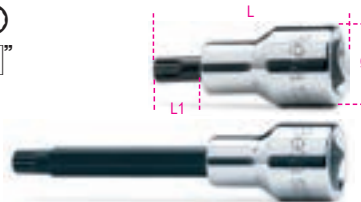

DIN 2324

Ø mm	L mm	L1 mm	12"	12"
M4	22,5	58	20	3 009200559
M5	22,5	58	20	3 009200560
M6	22,5	58	20	3 009200561
M6L	22,5	100	62	3 009200562
M8	22,5	58	20	3 009200563
M8L	22,5	100	62	3 009200564
M9	22,5	58	20	3 009200582
M9L	22,5	100	62	3 009200583
M10	22,5	58	20	3 009200565
M10L	22,5	100	62	3 009200566
M12	22,5	58	20	3 009200568
M12L	22,5	100	62	3 009200569

Ø mm	L mm	L1 mm	12"	12"
M14	23,0	58	20	3 009200571
M14L	23,0	100	62	3 009200572
M16	23,0	58	20	3 009200573
M18	23,0	58	20	3 009200574



920XZN/SB7
M4-M5-M6-M8
M10-M12-M14



1 009200579



920XZN/SB12
M5-M6-M8-M10-M12
M14-M16-M6L-M8L
M10L-M12L-M14L



1 009200577



920XZN-L/S5
M6L-M8L-M10L
M12L-M14L



1 009200578

920ES

special form socket drivers



UNI 9326

Ø mm	L mm	L1 mm	12"	12"
7	(6R)	58	20	5 009200587
7XL	(6R)	240	202	1 009200607
9	(8R)	58	20	5 009200589
9XL	(8R)	240	202	1 009200609
10	(8S)	58	20	5 009200590
10XL	(8S)	240	202	1 009200610
11	(10R)	58	20	5 009200591
11XL	(10R)	240	202	1 009200611
12L	(10S)	100	62	3 009200592
12XL	(10S)	240	202	1 009200612
14L	(12S)	100	62	3 009200594
14XL	(12S)	240	202	1 009200614
16L	(14R)	100	62	3 009200596
16XL	(14R)	240	202	1 009200616



920ES/SB7
7-9-10-11-12L-14L-16L



1 009200598



920ES-XL/SB7
7XL-9XL-10XL-11XL
12XL-14XL-16XL



1 009200618

920/15

adaptor, 1/2" female and 3/8" male drives



UNI/ISO 3316 DIN 3123

L	□	■	Ø		
mm	1/2	3/8	mm	5	009200810
42			22,0		



Always apply torque loads evenly and progressively to avoid breakage and any possible injury.

920/16

adaptor, 1/2" female and 3/4" male drives



UNI/ISO 3316 DIN 3123

L	□	■	Ø		
mm	1/2	3/4	mm	5	009200814
46			26		

920/20÷920/23

1/2" drive extension bars

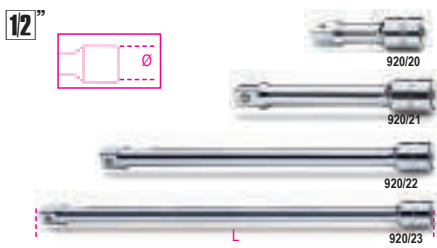

UNI/ISO 3316 DIN 3123

	L	Ø		
	mm	mm		
920/20	75	22	5	009200818
920/21	125	22	5	009200822
920/22	255	22	5	009200826
920/23	375	22	2	009200827

920AN

1/2" wobble extension bars

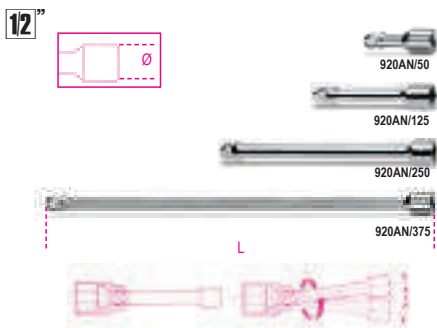

	L	Ø		
	mm	mm		
920AN/50	50	22	5	009200833
920AN/125	125	22	5	009200834
920AN/250	250	22	3	009200835
920AN/375	375	22	3	009200836

920/25

1/2" drive universal joint



UNI/ISO 3316 DIN 3123

L	Ø		
mm	mm	5	009200830
75	27		

920/35A

1/2" drive swivel handle



UNI/ISO 3315 DIN 3122

L	L1		
mm	mm	3	009200846
285	160		

920M/35

1/2" swivel drive with metal handle



UNI/ISO 3315 DIN 3122

L			
mm		2	009200845
380			

920M/35L

1/2" swivel drive with metal handle, long series



L			
mm		1	009200843
600			



Always apply torque loads evenly and progressively to avoid breakage and any possible injury.

920/36A

1/2" drive swivel handle



UNI/ISO 3315 DIN 3122

L	L1		
mm	mm	2	009200847
408	283		

920/38

1/2" extension drive swivel handle



L	L max		
mm	mm	1	009200839
262	402		

920/40

1/2" drive swivel T-handle



L	L1		
mm	mm	2	009200850
490	230		

920/42

1/2" drive sliding T handle

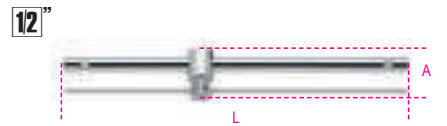

L	A		
mm	mm	5	009200854
305	42		

920/44

1/2" drive offset handle



L	L1		
mm	mm	3	009200858
230	60		

920/46

1/2" drive with speed brace

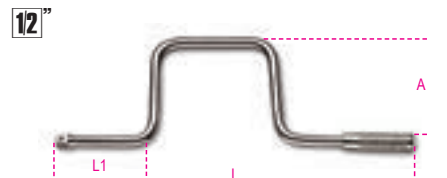

L	L1	A	
mm	mm	mm	
385	110	160	1 009200862

920/50

1/2" push-through drive ratchet,
72 teeth



UNI/ISO 3315 DIN 3122

L	Ø	A	
mm	mm	mm	
275	40	42	3 009200871

920/50F

1/2" female square drive ratchet,
72 teeth



UNI/ISO 3315 DIN 3122

L	Ø	A	
mm	mm	mm	
275	40	27	2 009200889

920/55

1/2" drive reversible ratchet,
72 teeth



UNI/ISO 3315 DIN 3122

L	Ø	A	
mm	mm	mm	
275	40	43	3 009200882

920/55Q

1/2" drive reversible ratchet, 48 teeth



UNI/ISO 3315 DIN 3122

L	Ø	A	
mm	mm	mm	
275	40	43	3 009200885

920/55X

1/2" drive reversible ratchet, 72 teeth



UNI/ISO 3315 DIN 3122

L	Ø	A	
mm	mm	mm	
200	30	33	3 009200895

920/55LC

1/2" drive reversible ratchet
"Locking System", 72 teeth



UNI/ISO 3315 DIN 3122

L	Ø	A	
mm	mm	mm	
275	40	43	2 009200896

920/55L

extension reversible ratchet,
1/2" male drive,
72 tooth mechanism



L	L max	Ø	A	
mm	mm	mm	mm	
282	422	40	43	1 009200927

920M/55

1/2" drive reversible ratchet
with metal handle



L	Ø	A	
mm	mm	mm	
253	38	35	1 009200893

920/56A

1/2" drive swivel reversible ratchet,
72 teeth



L	Ø	A	
mm	mm	mm	
315	40	43	1 009200911

920M/56

1/2" drive reversible swivel ratchet
with metal handle



L	Ø	A	
mm	mm	mm	
330	38	35,7	2 009200894

920/58

1/2" drive reversible ratchet
with rotating handle,
52 tooth mechanism

- Socket release button
- Ring nut reversal system on ratchet head
- Bi-material handle



L	Ø	A	
mm	mm	mm	
281	42,5	45	1 009200926

Spare parts
rotating mechanism of ratchets,
see table after item 929/C8

920.../C11

11 sockets and 2 accessories

12"



920A/C11

1 009200921

	○ 920A	10 - 12 - 13 - 14 - 15 - 16 17 - 18 - 19 - 21 - 22 mm
	920/22	255 mm
	920/50	
		335x145x60 mm - 2,5 kg

920B/C11

1 009200922

	○ 920B	10 - 12 - 13 - 14 - 15 - 16 17 - 18 - 19 - 21 - 22 mm
	920/22	255 mm
	920/50	
		335x145x60 mm - 2,5 kg

920.../C12...

12 sockets and 5 accessories

12"



920A/C12X

1 009200933

	○ 920A	10 - 11 - 12 - 13 - 14 - 17 - 19 22 - 24 - 27 - 30 - 32 mm
	920/21	125 mm
	920/22	255 mm
	920/25	
	920/42	
	920/55	
		420x185x60 mm - 4,2 kg

920A/C12

1 009200931

	○ 920A	10 - 11 - 12 - 13 - 14 - 17 - 19 22 - 24 - 27 - 30 - 32 mm
	920/21	125 mm
	920/22	255 mm
	920/25	
	920/42	
	920/50	
		420x185x60 mm - 4,2 kg

920B/C12X

1 009200934

	○ 920B	10 - 11 - 12 - 13 - 14 - 17 - 19 22 - 24 - 27 - 30 - 32 mm
	920/21	125 mm
	920/22	255 mm
	920/25	
	920/42	
	920/55	
		420x185x60 mm - 4,0 kg

920B/C12

1 009200932

	○ 920B	10 - 11 - 12 - 13 - 14 - 17 - 19 22 - 24 - 27 - 30 - 32 mm
	920/21	125 mm
	920/22	255 mm
	920/25	
	920/42	
	920/50	
		420x185x60 mm - 4,0 kg

920.../C20...

20 sockets and 5 accessories

12"



920A/C20X

1 009200950

	○ 920A	10 - 11 - 12 - 13 - 14 - 15 - 16 17 - 18 - 19 - 20 - 21 - 22 - 23 24 - 26 - 27 - 28 - 30 - 32 mm
	920/21	125 mm
	920/22	255 mm
	920/25	
	920/42	
	920/55	
		420x185x60 mm - 5,1 kg

920A/C20

1 009200948

	○ 920A	10 - 11 - 12 - 13 - 14 - 15 - 16 17 - 18 - 19 - 20 - 21 - 22 - 23 24 - 26 - 27 - 28 - 30 - 32 mm
	920/21	125 mm
	920/22	255 mm
	920/25	
	920/42	
	920/50	
		420x185x60 mm - 5,1 kg

920A/C20Q

1 009200955

	○ 920A	10 - 11 - 12 - 13 - 14 - 15 - 16 17 - 18 - 19 - 20 - 21 - 22 - 23 24 - 26 - 27 - 28 - 30 - 32 mm
	920/21	125 mm
	920/22	255 mm
	920/25	
	920/42	
	920/55Q	
		420x185x60 mm - 5,1 kg

920B/C20

1 009200949

	○ 920B	10 - 11 - 12 - 13 - 14 - 15 - 16 17 - 18 - 19 - 20 - 21 - 22 - 23 24 - 26 - 27 - 28 - 30 - 32 mm
	920/21	125 mm
	920/22	255 mm
	920/25	
	920/42	
	920/50	
		420x185x60 mm - 5,0 kg

920B/C20X

1 009200951

	○ 920B	10 - 11 - 12 - 13 - 14 - 15 - 16 17 - 18 - 19 - 20 - 21 - 22 - 23 24 - 26 - 27 - 28 - 30 - 32 mm
	920/21	125 mm
	920/22	255 mm
	920/25	
	920/42	
	920/55	
		420x185x60 mm - 5,0 kg

920.../C21...

21 sockets and 6 accessories

12"









920A/C21

1 009200952

	○ 920A	10 - 11 - 12 - 13 - 14 - 15 - 16 17 - 18 - 19 - 20 - 21 - 22 - 23 24 - 25 - 26 - 27 - 28 - 30 - 32 mm
	920/21	125 mm
	920/22	255 mm
	920/25	
	920/42	
	920/46	
	920/50	
		420x280x60 mm - 6,5 kg

920A/C21X





1 009200983

-  **920A** 10 - 11 - 12 - 13 - 14 - 15 - 16
17 - 18 - 19 - 20 - 21 - 22 - 23
24 - 25 - 26 - 27 - 28 - 30 - 32 mm
-  **920/21** 125 mm
-  **920/22** 255 mm
-  **920/25**
-  **920/42**
-  **920/46**
-  **920/55**

420x280x60 mm - 6,4 kg

920B/C21

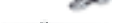

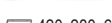



1 009200953

-  **920B** 10 - 11 - 12 - 13 - 14 - 15 - 16
17 - 18 - 19 - 20 - 21 - 22 - 23
24 - 25 - 26 - 27 - 28 - 30 - 32 mm
-  **920/21** 125 mm
-  **920/22** 255 mm
-  **920/25**
-  **920/42**
-  **920/46**
-  **920/50**

420x280x60 mm - 6,4 kg

920B/C21X

1 009200984

-  **920B** 10 - 11 - 12 - 13 - 14 - 15 - 16
17 - 18 - 19 - 20 - 21 - 22 - 23
24 - 25 - 26 - 27 - 28 - 30 - 32 mm
-  **920/21** 125 mm
-  **920/22** 255 mm
-  **920/25**
-  **920/42**
-  **920/46**
-  **920/55**

420x280x60 mm - 6,4 kg

920B/C30Q

30 bi-hex sockets and 5 accessories

12"

**920B/C30Q**

1 009200975

-  **920B** 8 - 9 - 10 - 11 - 12 - 13 - 14
15 - 16 - 17 - 18 - 19 - 20 - 21
22 - 23 - 24 - 26 - 27 - 30 mm
-  **920BL** 12 - 13 - 14 - 17 - 19 - 21
22 - 24 - 27 - 30 mm
-  **920/21** 125 mm
-  **920/22** 255 mm
-  **920/25**
-  **920/42**
-  **920/55Q**

420x280x60 mm - 7,6 kg









920.../C33

20 sockets, 13 socket drivers and 5 accessories

12"

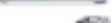
**920A/C33**

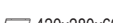





1 009200985

-  **920A** 10 - 11 - 12 - 13 - 14 - 15 - 16
17 - 18 - 19 - 20 - 21 - 22 - 23
24 - 26 - 27 - 28 - 30 - 32 mm
-  **920LP** 1,2x8 - 1,6x9 - 2x12 mm
-  **920PH** PH2 - PH3 - PH4
-  **920PE** 4 - 5 - 6 - 8 - 10 - 12 - 14 mm
-  **920/21** 125 mm
-  **920/22** 255 mm
-  **920/25**
-  **920/42**
-  **920/55**

420x280x60 mm - 6,7 kg

920B/C33

1 009200986

-  **920B** 10 - 11 - 12 - 13 - 14 - 15 - 16
17 - 18 - 19 - 20 - 21 - 22 - 23
24 - 26 - 27 - 28 - 30 - 32 mm
-  **920LP** 1,2x8 - 1,6x9 - 2x12 mm
-  **920PH** PH2 - PH3 - PH4
-  **920PE** 4 - 5 - 6 - 8 - 10 - 12 - 14 mm
-  **920/21** 125 mm
-  **920/22** 255 mm
-  **920/25**
-  **920/42**
-  **920/55**

420x280x60 mm - 6,7 kg

920/C37

37 bi-hex sockets and 5 accessories

12"

**920/C37**

1 009200988

-  **920B** 10 - 11 - 12 - 13 - 14 - 15 - 16
17 - 18 - 19 - 20 - 21 - 22 - 23
24 - 26 - 27 - 28 - 30 - 32 mm
-  **920AS** 3/8 - 7/16 - 1/2 - 9/16 - 19/32
5/8 - 11/16 - 3/4 - 25/32 - 13/16
7/8 - 15/16 - 1 - 1.1/16 - 1.1/8
1.3/16 - 1.1/4
-  **920/21** 125 mm
-  **920/22** 255 mm
-  **920/25**
-  **920/42**
-  **920/55**

420x280x60 mm - 7,5 kg











920AS/C10

10 bi-hex sockets and 2 accessories

12"



920AS/C10   1 009200919



	○ 920AS	3/8 - 7/16 - 1/2 - 9/16 - 5/8 - 11/16 - 3/4 - 13/16 - 7/8 - 15/16
	920/22	255 mm
	⊕ 920/50	
 335x145x60 mm -  2,6 kg		









920AS/C15

15 bi-hex sockets and 6 accessories

12"



920AS/C15   1 009200947



	○ 920AS	3/8 - 7/16 - 1/2 - 9/16 - 5/8 - 11/16 - 3/4 - 13/16 - 7/8 - 15/16 - 1.1/16 - 1.1/8 - 1.3/16 - 1.1/4
	920/21	125 mm
	920/22	255 mm
	920/25	
	920/42	
	920/46	
	⊕ 920/50	
 420x280x60 mm -  5,9 kg		



920AS/C17X

17 bi-hex sockets and 5 accessories

12"



920AS/C17X   1 009200942



	○ 920AS	3/8 - 7/16 - 1/2 - 9/16 - 19/32 - 5/8 - 11/16 - 3/4 - 25/32 - 13/16 - 7/8 - 15/16 - 1 - 1.1/16 - 1.1/8 - 1.3/16 - 1.1/4
	920/21	125 mm
	920/22	255 mm
	920/25	
	920/42	
	⊕ 920/55	
 420x185x60 mm -  4,8 kg		



920AS/MBM-C21

16 bi-hex sockets and 5 accessories for aeronautical maintenance

12"



920AS/MBM-C21   1 009200944



	○ 920AS	3/8 - 7/16 - 1/2 - 9/16 - 19/32 - 5/8 - 11/16 - 3/4 - 25/32 - 13/16 - 7/8 - 15/16 - 1 - 1.1/16 - 1.3/16 - 1.1/4
	920M/55	
	920/21	125 mm
	920/22	255 mm
	920/25	
	920/42	
 420x185x60 mm -  5,0 kg		

920TX/C17

6 bits, 6 sockets, 5 socket drivers and 4 accessories for Torx® head screws

12"



920TX/C17   1 009200989

	⊕ 861TX	T8 - T10 - T15 - T20 - T25 - T27
	897	
	⊕ 920TX	T27 - T30 - T40 - T45 - T50
	⊕ 920FTX	E10 - E12 - E14 - E16 - E18 - E20
	920/20	75 mm
	920/22	255 mm
	⊕ 920/55	
 420x185x60 mm -  2,9 kg		



920A/C17HR

17 hexagon sockets and 5 accessories in hard foam tray, in metal case

• ratchet with rotating handle

12"



920A/C17HR   1 009200939

	○ 920A	10-11-12-13-14-15-16-17-18-19-20-21-22-24-27-30-32 mm
	920/21	125 mm
	920/22	255 mm
	920/25	
	920/42	
	920/58	
 420x185x60 mm -  5,1 kg		

928A

hexagon hand sockets

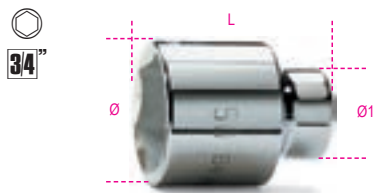

UNI/ISO 2725
DIN 3124

mm	Ø	L	Ø1		
19	29,2	50	34	5	009280019
21	30,0	51	34	5	009280021
22	31,3	53	34	5	009280022
23	33,3	53	34	5	009280023
24	34,5	53	34	5	009280024
26	36,8	55	35	5	009280026
27	38,0	56	35	5	009280027
28	39,0	57	35	3	009280028
29	40,2	58	35	3	009280029
30	41,5	58	37	3	009280030
32	44,3	60	37	3	009280032
33	45,8	60	37	3	009280033
34	46,8	60	37	3	009280034
35	48,1	62	38	3	009280035
36	49,5	64	38	3	009280036
38	52,0	68	40	3	009280038
41	56,0	71	40	3	009280041
46	62,3	75	43	3	009280046
50	67,4	80	43	3	009280050
55	73,7	84	48	1	009280055
60	80,0	87	48	1	009280060

928B

bi-hex hand sockets

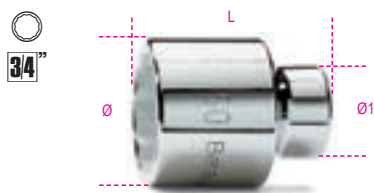

UNI/ISO 2725
DIN 3124

mm	Ø	L	Ø1		
19	29,2	50	34	5	009280119
21	30,0	51	34	5	009280121
22	31,3	53	34	5	009280122
23	33,3	53	34	5	009280123
24	34,5	53	34	5	009280124
26	36,8	55	35	5	009280126
27	38,0	56	35	5	009280127
28	39,0	57	35	3	009280128
29	40,2	58	35	3	009280129
30	41,5	58	37	3	009280130
32	44,3	60	37	3	009280132
33	45,8	60	37	3	009280133
34	46,8	60	37	3	009280134
35	48,1	62	38	3	009280135
36	49,5	64	38	3	009280136
38	52,0	68	40	3	009280138
41	56,0	71	40	3	009280141
46	62,3	75	43	3	009280146
50	67,4	80	43	3	009280150
55	73,7	84	48	1	009280155
60	80,0	87	48	1	009280160

928AS

hexagon hand sockets

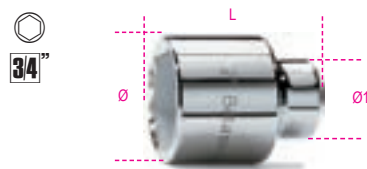

"	Ø	L	Ø1		
7/8	32,0	53	34	1	009280202
15/16	34,5	53	34	1	009280203
1	36,2	55	35	1	009280204
1.1/16	38,0	56	35	1	009280205
1.1/8	40,2	58	35	1	009280206
1.1/4	44,2	60	37	1	009280208
1.5/16	45,8	60	37	1	009280209
1.3/8	48,1	62	38	1	009280210
1.7/16	49,5	64	38	1	009280211
1.1/2	52,0	68	40	1	009280212
1.5/8	56,0	71	40	1	009280214
1.11/16	58,8	74	40	1	009280215
1.13/16	62,3	75	43	1	009280217
1.7/8	65,0	78	43	1	009280218
2	68,3	80	43	1	009280219
2.1/16	71,5	83	48	1	009280220

928ME

socket drivers for hexagon screws



mm	Ø	L	L1		
14	35	75	15,5	2	009280514
17	35	75	15,5	2	009280517
19	35	75	15,5	2	009280519
22	35	75	22,5	2	009280522

928/15

adaptor, 3/4" female and 1/2" male drives



UNI/ISO 3316
DIN 3123

L	Ø				
51,5	34	3/4	1/2	5	009280801

 Always apply torque loads evenly and progressively to avoid breakage and any possible injury.



928/16

adaptor, 3/4" female and 1" male drives



UNI/ISO 3316
DIN 3123

L	Ø				
65	34	3/4	1"	5	009280807

928/20 - 928/21 - 928/22

3/4" drive extension bars

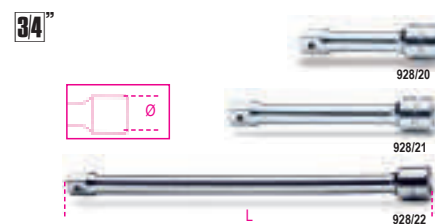

UNI/ISO 3316
DIN 3123

	L	Ø		
928/20	100	34	3	009280810
928/21	200	34	3	009280815
928/22	380	34	3	009280825

928/25

3/4" drive universal joint



UNI/ISO 3316 DIN 3123

L	Ø		
108	40	1	009280830

928/36A

3/4" drive swivel handle



DIN 3122 - UNI ISO 3315

L			
545		1	009280844

928/42

3/4" drive slide T-handle

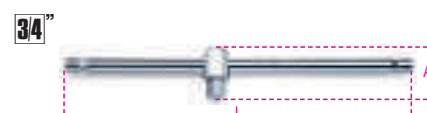

UNI/ISO 3315 DIN 3122

L	A		
450	62,5	3	009280850

928/55

3/4" drive reversible ratchet, 72 teeth



DIN 3122 - UNI ISO 3315

L mm	Ø mm	A mm	
510	58	59	2 009280862

Spare parts
rotating mechanism of ratchets,
see table after item 929/C8

928.../C12

assortment of 12 hexagon hand sockets and 5 accessories in sheet metal case



928A/C12

928A 22 - 24 - 27 - 30 - 32 - 34 - 36
38 - 41 - 46 - 50 - 55 mm

928/21	200 mm
928/22	380 mm
928/25	
928/42	
928/55	

530x220x80 mm - 13,5 kg

928B/C12

928B 22 - 24 - 27 - 30 - 32 - 34 - 36
38 - 41 - 46 - 50 - 55 mm

928/21	200 mm
928/22	380 mm
928/25	
928/42	
928/55	

530x220x80 mm - 13,5 kg

928AS/C12

assortment of 12 hexagon hand sockets and 5 accessories in sheet metal case



928AS/C12

928AS 7/8-15/16-1.1/16-1.1/8-1.1/4
1.5/16-1.7/16-1.1/2-1.11/16
1.13/16-1.7/8-2.1/16

928/21	200 mm
928/22	380 mm
928/25	
928/42	
928/55	

530x220x80 mm - 13,5 kg

929

hexagon hand sockets



UNI/ISO 2725 DIN 3124

Ø mm	L mm	Ø1 mm	
36	51	48	1 009290036
41	57	48	1 009290041
46	65	48	1 009290046
50	70	48	1 009290050
55	76	54	1 009290055
60	82	54	1 009290060
65	88	54	1 009290065
70	92	60	1 009290070
75	99	60	1 009290075
80	106	60	1 009290080

929/15

adaptor, 1" female and 3/4" male drives

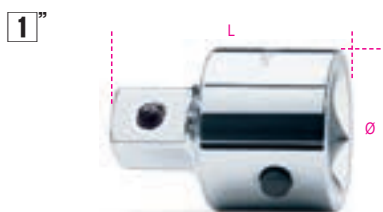

UNI/ISO 3316 DIN 3123

L mm	Ø mm			
65	47	1"	3/4"	2 009290801



Always apply torque loads evenly
and progressively to avoid breakage
and any possible injury.

929/21 - 929/22

1" drive extension bars



UNI/ISO 3316 DIN 3123

	L mm	Ø mm	
929/21	200	47	1 009290815
929/22	400	47	1 009290825

929/42

1" drive slide T-handle



UNI/ISO 3315 DIN 3122

L mm	
535	1 009290850

929/55

1" reversible ratchet 72 teeth



UNI/ISO 3315 DIN 3122

L mm	Ø mm	A mm	
770	62	63	1 009290860

929/C8

8 hexagon sockets and 5 accessories



929/C8

929 46 - 50 - 55 - 60 - 65
70 - 75 - 80 mm

929/15	□ 1" - ■ 3/4"
929/21	200 mm
929/22	400 mm
929/42	
929/55	

560x290x12 mm - 29 kg

900/R55

14"
40



900/R55
900/55

1 009000871

900M/R55

14"



900M/R55
900M/55

1 009000888

910/R55

38"
72



910/R55
606/6-606/10-612
666/6-666/10-910/55
599DGT/6

1 009100879

910M/R55

38"



910M/R55
910M/55-910M/56

1 009100888

910/R55Q

38"
40



910/R55Q
910/55Q

1 009100877

910/R55X

38"
40



910/R55X
666N/2X

1 009100897

920/R50

12"
72



920/R50
614/50-667/20-667/30
920/50

1 009200866

920/R55

12"
72



920/R55
606/20-606/30-666/20-666/30
920/55-920/56A- 599DGT/20-599DGT/30

1 009200879

920M/R55

12"



920M/R55
920M/55-920M/56

1 009200888

920/R55Q

12"
40



920/R55Q
920/55Q

1 009200877

920/R55X

12"
72

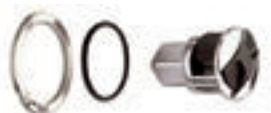

920/R55X
606/10X-612X
666/10X-920/55X-599DGT/10X

1 009200878

920/R55LC

12"
72



920/R55LC
920/55LC "Locking System"

1 009200887

928/R55

34"
72



928/R55
928/55

1 009280859

928/R55X

34"
72



928/R55X
614X

1 009280858

929/R55

1"
72



929/R55
929/55

1 009290859

930

double ended bi-hex tubular socket wrenches,
heavy series



UNI 6745

mm	L mm	Ø mm	Ø1 mm	
6x7	100	9,5	11,0	3 009300006
8x9	108	12,5	14,0	3 009300010
10x11	116	15,0	16,5	3 009300014
12x13	124	17,5	19,0	3 009300018
14x15	132	20,0	21,5	3 009300023
16x17	140	23,0	24,0	3 009300027
18x19	148	25,0	26,5	3 009300032
20x22	156	28,0	30,0	2 009300036
21x23	163	29,0	31,5	2 009300040
24x26	173	33,0	35,5	2 009300044
25x28	182	34,5	38,0	2 009300048
27x29	191	37,0	39,5	2 009300052
30x32	200	40,5	43,0	2 009300056



930/S8

6x7-8x9-10x11
12x13-14x15-16x17
18x19-20x22 mm

940/1 - /2

930/S13

6x7-8x9-10x11-12x13
14x15-16x17-18x19

20x22-21x23-24x26

25x28-27x29-30x32 mm

940/1 - /2 - /3

1 009300081

1 009300083

1 009200887



930/C13 1 009300098
 6x7-8x9-10x11-12x13
 14x15-16x17-18x19
 20x22-21x23-24x26
 25x28-27x29-30x32 mm
940/1 - /2 - /3

932
 double ended hexagon / bi-hex offset
 socket wrenches, bright chrome-plated

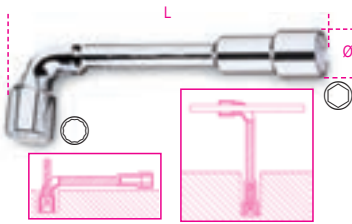

NF E 74.303

mm	Ø	L	
6x6	11,5	110	5 009320006
7x7	12,5	116	5 009320007
8x8	13,0	120	5 009320008
9x9	14,0	125	5 009320009
10x10	16,5	133	5 009320010
11x11	17,5	143	5 009320011
12x12	19,0	148	5 009320012
13x13	19,5	154	5 009320013
14x14	21,5	167	5 009320014
15x15	22,5	182	5 009320015
16x16	24,5	193	5 009320016
17x17	26,0	198	5 009320017
18x18	26,5	215	5 009320018
19x19	29,0	220	5 009320019
20x20	30,5	222	3 009320020
21x21	30,5	236	3 009320021
22x22	32,5	250	2 009320022
23x23	33,5	256	2 009320023
24x24	35,0	272	2 009320024
25x25	36,5	282	2 009320025
26x26	37,5	296	2 009320026
27x27	39,0	296	2 009320027
28x28	39,0	314	2 009320028
30x30	42,5	348	2 009320030
32x32	45,5	364	2 009320032



932/S11 1 009320080
 6-7-8-10-11-12
 13-14-17-19-22 mm
932/S17 1 009320081
 6-7-8-9-10-11-12
 13-14-15-16-17
 18-19-20-21-22 mm
932/S25 1 009320082
 6-7-8-9-10-11-12-13
 14-15-16-17-18-19
 20-21-22-23-24-25
 26-27-28-30-32 mm

933
 double ended offset hexagon
 socket wrenches, bright chrome-plated

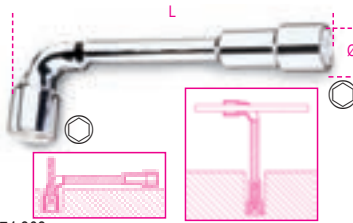

NF E 74.303

mm	Ø	L	
6x6	11,5	110	5 009330006
7x7	12,5	116	5 009330007
8x8	13,0	120	5 009330008
9x9	14,0	125	5 009330009
10x10	16,5	133	5 009330010
11x11	17,5	143	5 009330011
12x12	19,0	148	5 009330012
13x13	19,5	154	5 009330013
14x14	21,5	167	5 009330014
15x15	22,5	182	5 009330015
16x16	24,5	193	5 009330016
17x17	26,0	198	5 009330017
18x18	26,5	215	5 009330018
19x19	29,0	220	5 009330019
20x20	30,5	222	3 009330020
21x21	30,5	236	3 009330021
22x22	32,5	250	2 009330022
23x23	33,5	256	2 009330023
24x24	35,0	272	2 009330024
25x25	36,5	282	2 009330025
26x26	37,5	296	2 009330026
27x27	39,0	296	2 009330027
28x28	39,0	314	2 009330028
30x30	42,5	348	2 009330030
32x32	45,5	364	2 009330032



933/S11 1 009330080
 6-7-8-10-11-12
 13-14-17-19-22 mm
933/S17 1 009330081
 6-7-8-9-10-11-12
 13-14-15-16-17
 18-19-20-21-22 mm
933/S25 1 009330082
 6-7-8-9-10-11-12-13
 14-15-16-17-18-19
 20-21-22-23-24-25
 26-27-28-30-32 mm

935
 double ended hexagon tubular socket
 wrenches, light series



UNI 6746 DIN 896

mm	L	
6x7	100	5 009350105
8x9	110	5 009350111
10x11	120	5 009350115
12x13	130	5 009350117
14x15	140	5 009350126
16x17	150	5 009350128
18x19	160	5 009350131
20x22	170	3 009350138
21x23	180	3 009350141
24x26	190	3 009350144
25x28	200	2 009350150
27x29	210	2 009350153
30x32	220	2 009350156

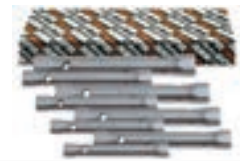

935/S8 1 009350181
 6x7-8x9-10x11
 12x13-14x15-16x17
 18x19-20x22 mm
940/1 - /2
935/S13 1 009350183
 6x7-8x9-10x11
 12x13-14x15-16x17
 18x19-20x22-21x23
 24x26-25x28-27x29
 30x32 mm
940/1 - /2 - /3

937
 double ended hexagon / bi-hex
 socket wrenches, chrome-plated

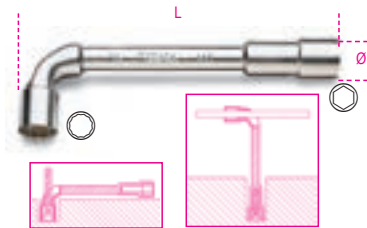

mm	Ø	L	
6x6	11,5	110	5 009370006
7x7	12,5	116	5 009370007
8x8	13,0	120	5 009370008
9x9	14,0	125	5 009370009
10x10	16,5	133	5 009370010
11x11	17,5	143	5 009370011
12x12	19,0	148	5 009370012
13x13	19,5	154	5 009370013
14x14	21,5	167	5 009370014
15x15	22,5	182	5 009370015
16x16	24,5	193	5 009370016
17x17	26,0	198	5 009370017
18x18	26,5	215	5 009370018
19x19	29,0	220	5 009370019
20x20	30,5	222	3 009370020
21x21	30,5	236	3 009370021
22x22	32,5	250	2 009370022
23x23	33,5	256	2 009370023
24x24	35,0	272	2 009370024
25x25	36,5	282	2 009370025
26x26	37,5	296	2 009370026
27x27	39,0	296	2 009370027
28x28	39,0	314	2 009370028
30x30	42,5	348	2 009370030
32x32	45,5	364	2 009370032



937/S11 1 009370080
 6-7-8-10-11-12
 13-14-17-19-22 mm
937/S17 1 009370081
 6-7-8-9-10-11-12
 13-14-15-16-17
 18-19-20-21-22 mm

940

tommy bars for tubular wrenches
items 930 and 935



	mm	L		
940/1	6+13	100	5	009400001
940/2	14+22	170	5	009400002
940/3	21+32	290	5	009400003

941

hexagon / bi-hex socket wrenches,
with high torque handles

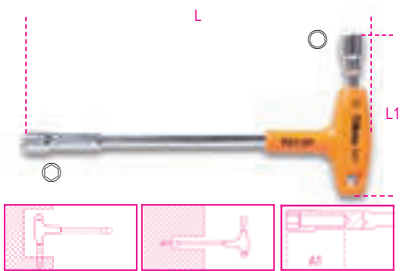

mm	L	L1	A1		
7x7	200	91	35	2	009410107
8x8	220	107	50	2	009410108
9x9	220	109	50	2	009410109
10x10	236	111	50	2	009410110
11x11	236	114	50	2	009410111
12x12	255	122	50	2	009410112
13x13	255	124	55	2	009410113



941/S7
7-8-9-10-11-12-13 mm
1 009410170

942BX

hi-torque hexagon nut spinners
short series



UNI 6750

mm	L	L1	A1		
4	190	70	13,0	5	009420003
5	190	70	14,0	5	009420004
5,5	190	70	12,5	5	009420005
6	190	70	14,5	5	009420006
7	190	70	15,5	5	009420007
8	202	70	18,5	5	009420008
9	202	70	19,5	5	009420009
10	202	70	20,5	3	009420010
11	202	70	21,5	3	009420011
12	202	70	22,5	3	009420012
13	202	70	23,5	3	009420013
14	202	70	24,5	3	009420014



942BX/S12
4-5-5,5-6-7-8-9
10-11-12-13-14 mm
1 009420030

943BX

hi-torque hexagon nut spinners
long series



ISO 2236 UNI 6750

mm	L	L1	A1		
4	270	150	13,0	5	009430003
5	270	150	14,0	5	009430004
5,5	270	150	12,5	5	009430005
6	270	150	14,5	5	009430006
7	270	150	15,5	5	009430007
8	282	150	18,5	5	009430008
9	282	150	19,5	5	009430009
10	282	150	20,5	3	009430010
11	282	150	21,5	3	009430011
12	282	150	22,5	3	009430012
13	282	150	23,5	3	009430013
14	282	150	24,5	3	009430014



943BX/S12
4-5-5,5-6-7-8-9
10-11-12-13-14 mm
1 009430030



943BX/D6
5-6-7-8-10-13 mm
1 009430026



943FL

flexible hexagon nut spinners
with handles



mm	L	L1	Ø		
5	265	150	8	2	009430304
5,5	265	150	8	2	009430305
6	265	150	9	2	009430306
7	265	150	11	2	009430307
8	265	150	12	2	009430308
10	290	175	14	2	009430310



943FL/S6
5-5,5-6-7-8-10 mm
1 009430320

944BX

deep, hi-torque hexagon nut spinners
long series



ISO 2236 UNI 6750

mm	L	L1	A1		
4	245	125	20	3	009440003
5	245	125	25	3	009440004
5,5	245	125	30	3	009440005
6	245	125	35	3	009440006
7	245	125	35	3	009440007
8	257	125	50	3	009440008
9	257	125	50	3	009440009
10	257	125	50	3	009440010
11	257	125	50	3	009440011
12	257	125	50	3	009440012
13	257	125	55	3	009440013
14	257	125	55	3	009440014



944BX/S12
4-5-5,5-6-7-8-9
10-11-12-13-14 mm
1 009440062



944BX/D6
5-6-7-8-10-13 mm

1 009440056

949

deep T-handle socket wrenches

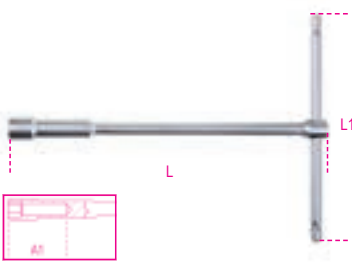

mm	L mm	L1 mm	A1 mm
8	220	160	50
10	230	160	50
12	240	175	50
13	244	175	55
14	250	190	55
17	264	200	60

2 009490008
2 009490010
2 009490012
2 009490013
2 009490014
2 009490017

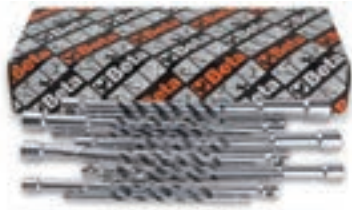

949/S6
8-10-12-13-14-17mm

1 009490076

950

T-handle hexagon socket wrenches

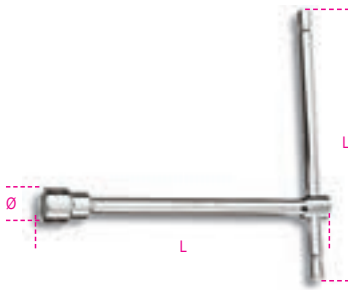

UNI 6742 DIN 3112

mm	L mm	Ø mm	L1 mm
6	210	10,1	145
7	212	11,2	145
8	220	12,4	160
9	223	13,5	160
10	230	14,9	160
11	233	16,1	160
12	240	17,5	175
13	244	19,7	175
14	250	20,1	190
15	254	21,5	190
16	260	22,7	200
17	264	24,1	200
19	274	26,6	230
22	290	29,9	290
24	300	32,2	320
27	315	36,2	370

3 009500006
3 009500007
3 009500008
3 009500009
3 009500010
3 009500011
3 009500012
3 009500013
3 009500014
3 009500015
3 009500016
3 009500017
3 009500019
2 009500022
2 009500024
2 009500027



950/S9
7-8-10-11-12
13-14-17-19 mm

1 009500079

950/S14
6-7-8-9-10-11-12-13
14-15-16-17-19-22 mm

1 009500082

951

T-handle wrenches with three hexagon male ends

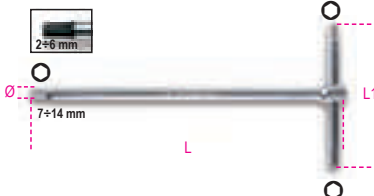

mm	L mm	L1 mm	Ø mm
2	125	63	4,0
2,5	150	63	4,0
3	150	63	4,0
3,5	175	76	5,5
4	175	76	5,5
4,5	195	87	6,5
5	195	87	6,5
6	215	99	8,0
7	230	109	9,0
8	250	122	10,0
9	265	132	11,0
10	280	142	12,0
12	305	160	15,0
14	330	178	17,0

5 009510521
5 009510525
5 009510530
5 009510535
5 009510540
5 009510545
5 009510550
5 009510560
5 009510570
5 009510580
5 009510590
5 009510610
3 009510620
3 009510640

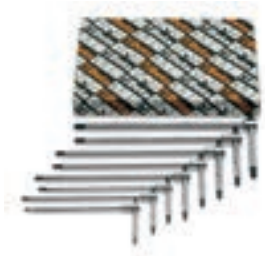

951/S6
2,5-3-4-5-6-8 mm

1 009510687

951/S8
2-2,5-3-3,5-4-4,5-5-6 mm

1 009510693

951/S14
2-2,5-3-3,5-4-4,5
5-6-7-8-9-10-12-14 mm

1 009510695



951/SP6
3-4-5-6-8-10 mm

1 009510696

951/SPV

1 009510697

951AS

T-handle wrenches with three hexagon male ends

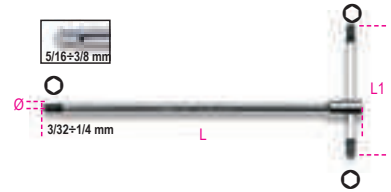

"	L mm	L1 mm	Ø mm
3/32	125	63	4,0
7/64	150	63	4,0
1/8	150	63	4,0
9/64	175	76	5,5
5/32	175	76	5,5
3/16	195	86	6,5
7/32	215	99	8,0
1/4	230	109	9,0
5/16	250	122	10,0
3/8	280	142	12,0

2 009510750
2 009510751
2 009510752
2 009510753
2 009510754
2 009510755
2 009510757
2 009510758
2 009510759
2 009510760

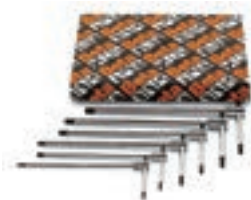

951AS/S6X
1/8-3/16-7/32-1/4-5/16-3/8

1 009510771



951TX

T-handle wrenches with three male ends for Torx® head screws



Ø	L mm	L1 mm	Ø mm		
T6	125	63	4	3	009510806
T7	125	63	4	3	009510807
T8	125	63	4	3	009510808
T9	125	63	4	3	009510809
T10	150	63	4	3	009510810
T15	150	63	4	3	009510815
T20	175	76	5	3	009510820
T25	175	76	5	3	009510825
T27	195	87	6	3	009510827
T30	195	87	6	3	009510830
T40	215	99	7	3	009510840
T45	230	109	8	3	009510845
T50	250	122	9	3	009510850

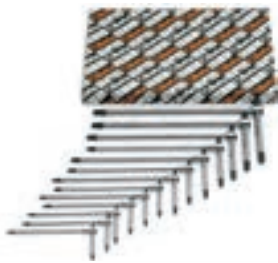

951TX/S6	1	009510866
T8-T10-T15-T20-T25-T30		
951TX/S13	1	009510863
T6-T7-T8-T9-T10-T15-T20-T25		
T27-T30-T40-T45-T50		

952

T-handle wrenches with swivelling hexagon sockets

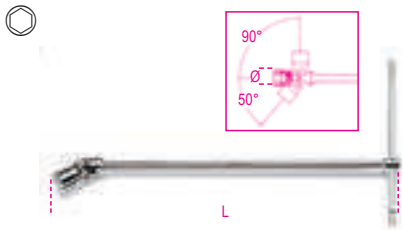

UNI 6743

Ø	Ø	L		
mm	mm	mm		
6	9,5	395	5	009520006
7	10,7	395	5	009520007
8	12,1	395	5	009520008
9	13,2	395	5	009520009
10	14,6	400	5	009520010
11	15,8	400	5	009520011
12	17,0	400	5	009520012
13	18,7	432	5	009520013
14	19,7	432	5	009520014
15	20,9	450	3	009520015
16	22,0	450	3	009520016
17	23,4	450	3	009520017
18	24,7	450	3	009520018
19	26,0	500	3	009520019
20	27,4	500	3	009520020
21	28,5	500	3	009520021
22	29,7	500	3	009520022
24	32,4	500	3	009520024



952/S7	1	009520074
8-10-11-13-14-17-19 mm		
952/S10	1	009520080
7-8-10-11-12-13-14-15-17-19 mm		
952/S18	1	009520083
6-7-8-9-10-11-12-13-14-15-16-17-18-19-20-21-22-24 mm		

952AS

T-handle wrenches with swivelling hexagon sockets

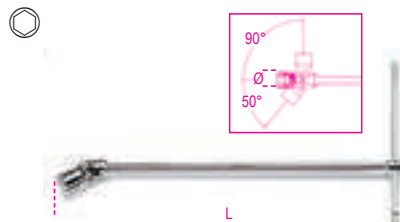

Ø	Ø	L		
"	mm	mm		
1/4	9,5	395	2	009520256
5/16	12,1	395	2	009520258
3/8	14,6	400	2	009520260
7/16	15,8	400	2	009520261
1/2	18,7	432	2	009520263
9/16	19,7	432	2	009520264
5/8	22,0	450	2	009520266
11/16	23,4	450	2	009520267
3/4	26,0	500	2	009520269

952L

T-handle wrenches with swivelling hexagon sockets, long series

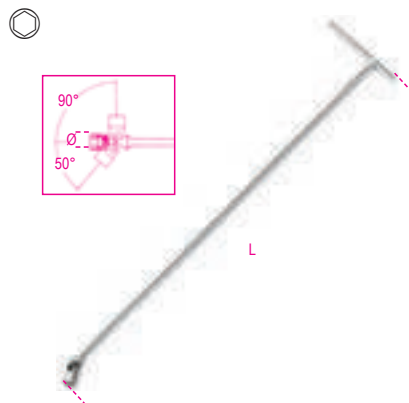

Ø	Ø	L		
mm	mm	mm		
10	14,6	930	1	009520410
12	17,0	1063	1	009520412
13	18,7	1100	1	009520413
14	19,7	1100	1	009520414
15	20,9	1100	1	009520415
16	22,0	1100	1	009520416
17	23,4	1100	1	009520417
18	24,7	1100	1	009520418
19	26,0	1100	1	009520419

952FTX

T-handle wrenches with swivelling socket, for Torx® head screws

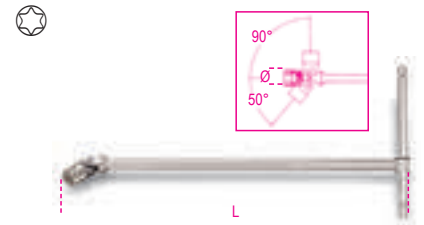

Ø	L			
mm	mm			
E6	8	392	2	009520106
E7	9	392	2	009520107
E8	10	395	2	009520108
E10	13	400	2	009520110
E12	15	440	2	009520112
E14	17	490	2	009520114
E16	19	490	2	009520116
E18	21	490	2	009520118
E20	23	490	2	009520120



952FTX/S9	1	009520141
E6-E7-E8-E10-E12-E14-E16-E18-E20		

953

T-handle wrenches with swivelling hexagon male ends

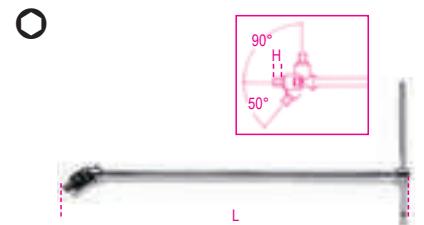

UNI 6754

mm	H	L		
mm	mm	mm		
3	5	395	5	009530130
3,5	6	395	3	009530135
4	6	395	5	009530140
4,5	7	395	3	009530145
5	7	395	5	009530150
6	9	400	5	009530160
7	10	425	3	009530170
8	11	425	5	009530180
10	13	440	5	009530200



953/S5	1	009530305
3-4-5-6-8 mm		
953/S9	1	009530301
3-3,5-4-4,5-5-6-7-8-10 mm		

953TX

T-handle wrenches with swivelling end for Torx® head screws

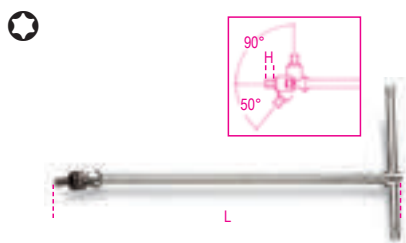

mm -"	H mm	L mm	QTY	Part No.
T20	11	396	2	009530020
T25	11	396	2	009530025
T27	11	396	2	009530027
T30	13	400	2	009530030
T40	13	400	2	009530040
T45	13	426	2	009530045
T50	14	442	2	009530050
T55	14	442	2	009530055



Part No.	QTY	Part No.
953TX/S8	1	009530060
T20-T25-T27-T30		
T40-T45-T50-T55		

955

tubular spark-plug wrench
chrome-plated, hexagon end

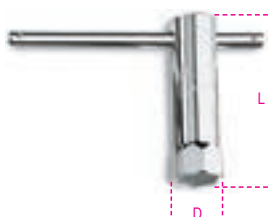

mm -"	D mm	L mm	QTY	Part No.
16	21	86	3	009550016
5/8				
20,8	29	86	3	009550021
13/16				

956C

1/2" square drive spark plug sockets
chrome-plated, hexagon ends

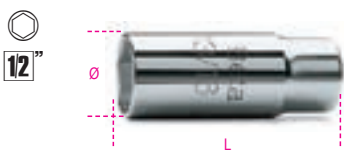

mm -"	Ø mm	L mm	QTY	Part No.
14	18,8	70	3	009560008
9/16				
16	21,4	70	3	009560010
5/8				
17,8	23,6	70	3	009560011
11/16				
20,8	27,0	70	3	009560012
13/16				

956E

3/8" square drive spark plug sockets
chrome-plated, hexagon ends



mm -"	Ø mm	L mm	QTY	Part No.
14	18,8	70	3	009560018
9/16				
16	21,4	70	3	009560020
5/8				
17,8	23,6	70	3	009560021
11/16				
20,8	27,0	70	3	009560022
13/16				

956F

3/8" square drive spark plug sockets



mm -"	Ø mm	L mm	QTY	Part No.
14	18,8	70	1	009560114
9/16				
16	20,5	70	1	009560116
5/8				

956L

1/2" square drive spark plug sockets,
bi-hex ends, long series



mm -"	Ø mm	L mm	QTY	Part No.
14	20,2	250	2	009560214
9/16				
16	24,0	250	2	009560216
5/8				
17,8	24,0	250	2	009560217
11/16				
20,8	28,5	250	2	009560221
13/16				

957

T-handle spark plug wrenches
with swivelling sockets

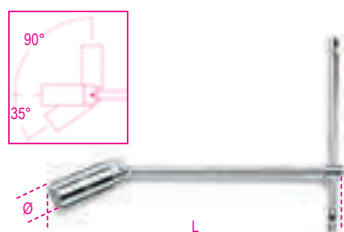

mm -"	Ø mm	L mm	QTY	Part No.
16	21,4	275	3	009570000
5/8				
20,8	27,0	275	3	009570001
13/16				

959

T-handle spark plug wrenches
with swivelling sockets, standard series

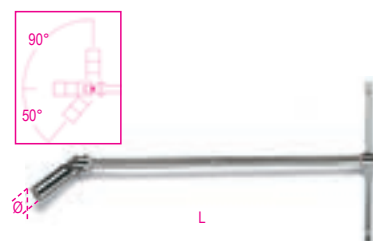

mm -"	Ø mm	L mm	QTY	Part No.
14	18,8	483	3	009590009
9/16				
16	21,4	483	3	009590010
5/8				
20,8	27,0	527	3	009590011
13/16				

959R

rubber inset and spare spring
for items 956C - 956E - 957 - 959

Part No.	QTY	Part No.
959R/14	3	009590223
956C/14-956E/14		
959R/16	3	009590224
956C/16-956E/16		
957/16-959/16		
959R/17,8	3	009590225
956C/17,8-956E/17,8		
959R/20,8	3	009590226
956C/20,8-956E/20,8		
957/20,8-959/20,8-959L		

960

1/2" square drive socket
for Diesel engine injectors



mm	Ø mm	L mm	QTY	Part No.
27	36,5	77	2	009600027

960A

1/2" square drive socket
for Diesel engine injectors

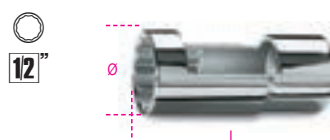

mm	Ø mm	L mm	QTY	Part No.
27	36,5	77	2	009600017

960BT

sockets for injector electrical connections

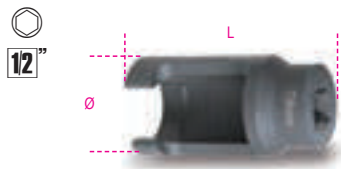

mm	Ø	L		
25	37,0	78	1	009600125
27	39,7	78	1	009600127
29	42,0	78	1	009600129
30	43,0	78	1	009600130

960BT/B

sockets for injector electrical connections

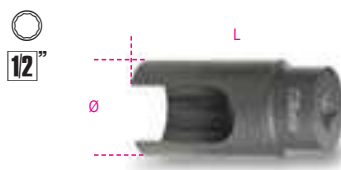

mm	Ø	L		
29	38,5	77	1	009600128

960F

socket for nozzle holder ring nuts



mm	Ø	Ø1	●1	●2		
28,3	22	32	22		1	009600148

960G

socket for Diesel engine injectors of Mercedes-Benz trucks



mm	Ø	Ø1	●	L		
28,5	22	32	122		1	009600151

960L

socket for nozzle holder ring nuts

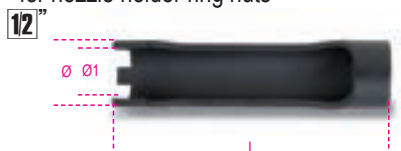

mm	Ø	Ø1	L		
30	22	122		1	009600153

960M

socket for nozzle holder ring nuts

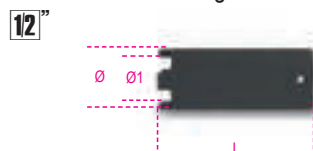

mm	Ø	Ø1	L		
28,5	22	72		1	009600154

960H/C4

set of sockets for nozzle holder ring nuts



960H/C4			1	009600152

960S

1/2" square drive socket for Diesel engine injectors

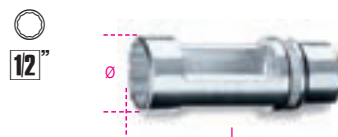

mm	Ø	L		
22	30	82	1	009600022

960SL

sockets for Lambda probes with 1/2" female square drives



	Ø			
960SL85	33		2	009600085
○ 22xL= 85 mm				
960SL110	33		2	009600110
○ 22xL= 110 mm				

960SN

Diesel engine glow plug wrenches



mm	Ø	□	L		
8	12,0	1/4	60	2	009600834
9	13,3	1/4	60	2	009600835
10	14,5	3/8	70	2	009600836
11	15,8	3/8	70	2	009600837
12	17,0	3/8	70	2	009600838

960/22EP

double head swivel socket wrench for Lambda probes

Double hexagon/bi-hex and 180° joint result in remarkable versatility



mm	L	Ø	Ø		
300	22	22		1	009600052

960/C6

3/8" female drive hexagon sockets for removing/installing exhaust gas temperature sensors

Kit contents:
• 3 short sizes, 13, 14, 17 mm
• 3 long sizes, 13, 14, 17 mm



960/C6			1	009600055

170x120x50 mm

960/D

open hexagon wrenches, long series, for removing/installing exhaust gas temperature sensors



mm				
13			1	009600073
14			1	009600074
17			1	009600077

960YP

open offset hexagon wrenches for removing/installing exhaust gas temperature sensors

30"



mm	
13	1 009600063
14	1 009600064
17	1 009600067

960AVE

device for testing common rail diesel electrical injectors



960AVE	
1	009600245

430x310x50 mm - 2,0 kg

960CMB

instrument for controlling compression on petrol engines



Bar	
4÷17	1 009600250

440x370x100 mm - 2,2 kg

960CMB/R2

spare cards for item 960CMB



960CMB/R2	
1	009600252

960CMD

instrument for controlling compression on Diesel engines



Bar	
8÷40	1 009600270

440x370x100 mm - 2,4 kg

960CMD/R1

spare cards for item 960CMD



960CMD/R1	
1	009600271

960EPC

Set of tools for removing glow plug electrode

M8x1 - M9x1 - M10x1 - M10x1,25



960EPC	
1	009600790

270x230x80 mm - 900 g

960EPC/L

set of tools for removing glow plug electrode face

M8x1 - M9x1 - M10x1 - M10x1.25



960EPC/L	
1	009600890

270x230x80 mm - 2 kg

960E-PI/P

injector washer extractor

• Male thread M10 for use with sliding hammer (Beta 1540)



960E-PI/P	
1	009600706

300x90x60 mm

960KC-M8/M9/M10

assortment of tools for removing broken or damaged glow plugs

• For spark plugs with threads M8-M9-M10



960KC-M8/9/10	
1	009600801

380x290x50 mm - 2,3 kg

960KPC

reversible impulse extractor with adjustable torque for glow plugs

Torque can be adjusted in 4 positions:
10-20-30-40 Nm



960KPC

8-9-10-11-12 mm

420x185x60 mm - 2,8 kg

1 009600780

960UC

tool set for removing stuck M8-M9-M10 glow plugs with deformed tips



960UC

270x230x80 mm - 2,6 kg

1 009600900

960P

pressure/depressure tester with accessories and adaptors



960P

350x320x95 mm - 1,9 kg

1 009600777

960PI

assortment of reamers for cleaning injector seats in plastic case

For removing residues from injector seats

- Flat reamer, Ø 19 - 15 mm, for universal injectors
- Flat reamer, Ø 17 - 17 mm, for Delphi/Bosch injectors (BMW/PSA/Renault/Ford)
- Flat reamer, Ø 19 - 17 mm, for Bosch injectors (Mercedes CDI).
- Angled reamer, Ø 21 - 17 mm, for Fiat/Iveco injectors.
- Handle



960PI

250x130x50 mm - 600 g

1 009600215

960PI/C19

assortment of 19 tools for cleaning injector seats

Kit contents:

- 11 flat reamers, Ø:
14/14 mm - 15.5/15.5 mm - 15/19 mm - 17/19 mm - 17/17.5 mm
17/19 mm - 17/19.5 mm - 17/20 mm - 18/21 mm - 19 mm - 20/21 mm
- 4 angled reamers, Ø:
15.5/15.5 mm - 17/17 mm - 17.5/20.5 mm - 17/21 mm
- Handle and cutter accessories



960PI/C19

360x230x60 mm

1 009600217

960PI/S

kit for cleaning injector seats

Kit contents:

- 3 steel brushes, Ø 18, 22, 25 mm, for cleaning injector seats
- 2 brushes, Ø 14 and 16 mm, for cleaning injector seat bottoms
- 6 caps for closing hole connecting with combustion chamber
- 1 brush for cleaning hole connecting with combustion chamber
- 1 flexible bit holder with handle



960PI/S

360x140x50 mm - 700 g

1 009600214

960RPI

blowing tool for injectors seat cleaning

for M8x1 - M9x1 - M10x1 - M10x1.25 glow plugs



960RPI

1 009600940

960PMC

Diesel injector test and calibrating hand pump



Bar Max.
400

1 009600200

960AVL

vapour extractor



Bar Max.
6

1 009600210

Beta

961D

Digital electronic videoscope with 5.5 mm probe

- Allows individual still images and video clips to be recorded and played back directly on tool



- Probe with head Ø 5.5 mm and length 90 cm
- LCD TFT display, 7" (18 cm), with resolution 800x480
- digital camera with front and side view
- "Cfast"-type probe connection
- image repetition frequency: 15 frames per second
- 2x digital zoom
- micro-USB connector for uploading images
- micro-HDMI video output
- Micro-SD card input
- Micro-USB input
- power supply allows unit to be used while battery is charging
- microphone and speaker for adding and listening to voice annotations while recording/playing back
- Wi-Fi connection

961D 1 009610500

400x340x85 mm - 2,6 kg

961D DC5,5

90-cm probe with 5.5-mm front and side camera for videoscope item 961D



961D/DC5,5 1 009610517

961D/CF3,8

1-m probe with 3.8-mm front camera for videoscope item 961D



961D/CF3,8 1 009610511

961D/DC8,5

1-m probe with dual UV camera for videoscope item 961D



961D/DC8,5 1 009610513

961P6

electronic videoscope with flexible probe



- Supports SD cards (8 GB)
- Supports flash memories (8 GB)
- Internal memory: 128M
- TV-OUT feature
- Supports video formats (MP4, AVI, 3GP)
- 4 LEDs
- Power supplied by USB port (built-in battery)

SPECIFICATIONS

- Sensor pixels: 640x480
- Maximum resolution: 320x240
- Probe length: 1 m
- Camera diameter: 6 mm
- Video formats: MPEG4, 3GP, AVI, ASF.
- Photo formats: JPEG
- Shooting angle: 0+180°
- Data output: USB cable and SD card
- Power supply: 3.7V 2000 mAh battery

961P6 1 009610000

961P6/S

flexible probes, 6 mm



	L mm	A mm	
961P6/S1	1000	21	1 009610006
961P6/S2	2000	25	1 009610262
961P6/S3	3000	27	1 009610263

962

tyre levers



L mm	A mm	
300	21	5 009620003
400	25	5 009620004
500	27	3 009620005
600	27	3 009620006

962P

tyre levers with non-scratch rubber protection



L mm	A mm	
490	25	1 009620049

962M

tyre removal/installation tool

particularly recommended for runflat tyres and lower shoulder models

- non-scratch rim locking jaws
- tyre removal lever seat



962M 1 009620501

963

pry bar with pointed and flat bent ends



L mm	A mm	
400	23	5 009630001

964

pry bar with pointed and leverage ends



L mm	A mm	
400	46	5 009640001

965

pry bars with flat curved ends



L mm	A mm	L1 mm	
300	16	185	2 009650013
450	20	312	2 009650014
600	20	462	2 009650016



965/S3 1 009650019

966/C3

set of 3 levers with articulated, flat, curved heads



966/C3	1	009660103
L=200-250-300 mm		
355x140x65 mm - 1,8 kg		

720LS

impact sockets, long, slim series



UNI/ISO 2725

720LS 36	2	007200386
Ø	L	Ø1
mm	mm	mm
36	48,0	78
29		

969B

hub nut locking socket

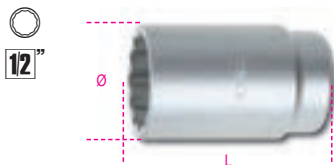

969B	Ø	L	
mm	mm	mm	
24	36,0	76	1 009690124
27	36,0	76	1 009690127
30	40,0	76	1 009690130
31	42,0	76	1 009690131
32	42,5	76	1 009690132
34	45,0	76	1 009690134
35	46,0	76	1 009690135
36	49,0	76	1 009690136

969/C5

set of 5 hub nut locking sockets in plastic case



969/C5	1	009690201
969B	30-32-34-35-36	

970EA

impact sockets for axle nuts



970EA	Ø	1	009700398
mm	mm		
98	36	122	

970EB

impact sockets for axle nuts



970EB	Ø	1	009700595
mm	mm		
95	36	126	
110	36	133	1 009700410

970Q

impact sockets for rectangular nuts



970Q	L	1	009700756
mm	mm		
56	3/4"		
60	3/4"		1 009700760

970B

socket for locking Fiat Daily hub nuts

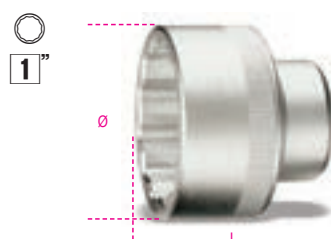

970B	Ø	L	1	009700010
mm	mm	mm		
65	88	75		

970C

octagonal impact sockets for locking hub nuts



970C	Ø	1	009700808
mm	mm		
80	41 mm		
95	3/4"		1 009700815
100	3/4"		1 009700820
109	41 mm		1 009700829
115	3/4"		1 009700835
120	41 mm		1 009700840

9700T

oval impact sockets for locking trailer hub nuts



9700T	L	L1	Ø	1	009700165
mm	mm	mm	mm		
65	61		3/4"		
80	73		3/4"		1 009700180
96	90		3/4"		1 009700196
111	104	41 mm			1 009700211

971TSP

tyre pressure sensor tool



SPECIFICATIONS

- reading of TPMS sensor information, including:
 - sensor ID
 - inflation pressure
 - temperature
 - battery state
- sensor activation
- universal sensor programming

The tool has a database which supports repair operations, including:

- driving torques
- codes of original spare parts and compatible universal sensors

971TSP	1	009710025
63x142x30 mm		

971/C8

torque screwdriver with accessories for controlled tightening of tyre valves with pressure control system



971/C8 1 009710108

	583/6	1,2+6 Nm
	892/0	
	862TX	T10-T15-T20
	900L	11-12 mm
	986 78	

978 - 979

four-way hexagon wheel nut wrenches

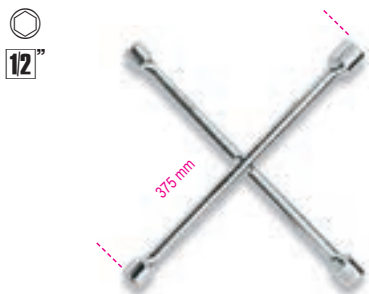

UNI/ISO 6788 DIN 3119

978 2 009780001

17x19x21x22 mm

979 2 009790001

17x19x22x1/2 mm

982

four-way hexagon wheel nut wrench

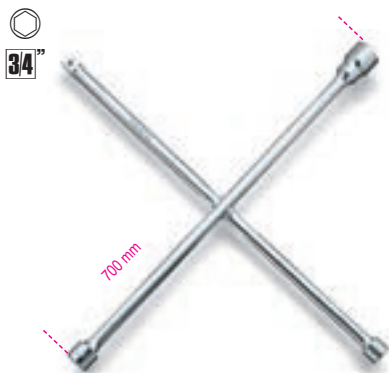

UNI/ISO 6788 DIN 3119

24x27x32x3/4 mm 1 009820001

984

wheel nut plastic cap pliers



L mm 195 H mm 4 1 009840005

985/B7

assortment of 7 guide pins for wheel installation

- Included sizes:
- M12X1.25 male
 - M12x1.25 female
 - M12x1.5 male
 - M12x1.5 female
 - M14x1.25 male
 - M14x1.5 male
 - M16x1.5 male



985/B7 1 009850007

985M

male guide pins for wheel installation



	L mm	
985M M12X1,25	150	1 009850101
985M M12X1,50	150	1 009850102
985M M14X1,25	150	1 009850103
985M M14X1,50	150	1 009850104
985M M16X1,50	150	1 009850105

985F

female guide pins for wheel installation



	L mm	
985F M12X1,25	150	1 009850106
985F M12X1,50	150	1 009850107

986 48

tyre valve screwdriver, short model automatic valve retention

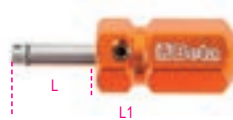

L mm 18 L1 mm 48 1 009860048

986 78

tyre valve screwdriver automatic valve retention



L mm 18 L1 mm 78 1 009860078

986PT

tyre valve screwdriver, precalibrated, 0.4 Nm

automatic valve retention slip mechanism prevents valve core gasket from getting damaged



L mm 19 L1 mm 120 1 009860140

987

tyre valve lever with rubber protection



L mm 310 1 009870001



987AR

tyre valve lever
with non-scratch fulcrum

- rubber and nylon fulcrum
for alloy and iron rims
- valve quick coupling,
does not require screwing



L
mm
305

1 009870021

987P

tyre valve lever
made of plastic

Handle accommodates screwdriver to work on
mechanism inside valve



L
mm
335

1 009870011

988/K4

set of 4 scratchproof plastic flat chisels



988/K4
A= 19-21-25-38 mm

1 009880104

989

wheel balancing weight tool



L
mm
250

2 009890001

989A

pliers for removing wheel balancing adhesive
weights



Nose profile specially designed to
remove weights without making contact with rim

L
mm
220

1 009890011

990

straight thin knurled point spring
tweezers made from stainless steel
bright finish

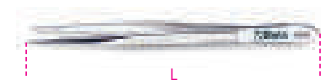

L
mm
130

5 009900001

991

bent thin knurled point spring tweezers
made from stainless steel, bright finish



L
mm
130

5 009910001

992

straight thin knurled point pin spring tweezers
made from stainless steel bright finish



L
mm
150

5 009920001

993

bent thin knurled point pin spring
tweezers made from stainless steel
bright finish



L
mm
145

5 009930001

993PL

bent thin knurled point pin spring
tweezers made from stainless steel
PVC-coated



L
mm
150

3 009930010

993G

pin spring tweezers, curved round
ends, knurled made from stainless
steel bright finish



L
mm
160

3 009930030

994

straight large knurled point spring
tweezers made from stainless steel
bright finish



L
mm
150

5 009940001

994PL

straight large knurled point spring
tweezers made from stainless
steel PVC-coated



L
mm
150

3 009940010

994TF

spring tweezers, acid and magnetic
resistant, large round noses,
strong and knurled ends
made from stainless steel semi-bright finish



L
mm
150

3 009940020

996

straight end spring tweezers with wide tips made from stainless steel bright finish



L mm 150 5 009960001

998

cross knurled end spring tweezers made from stainless steel bright finish



L mm 135 5 009980001

999

flat round end spring tweezers, acid and magnetic resistant made from stainless steel semi-bright finish



L mm 115 3 009990011

999A

extra slim short end spring tweezers, acid and magnetic resistant made from stainless steel semi-bright finish



L mm 120 3 009990015

999B

strong straight end spring tweezers, acid and magnetic resistant made from stainless steel semi-bright finish



L mm 120 3 009990017

999C

extra slim straight end spring tweezers, acid and magnetic resistant made from stainless steel semi-bright finish



L mm 110 3 009990019

999D

extra slim angled end spring tweezers, acid and magnetic resistant made from stainless steel semi-bright finish



L mm 115 3 009990021

999E

extra slim curved end spring tweezers, acid and magnetic resistant made from stainless steel semi-bright finish



L mm 120 3 009990023

999G

extra slim straight end spring tweezers, acid and magnetic resistant with stop mechanism made from stainless steel semi-bright finish



L mm 140 3 009990027

999/B6

set of 6 spring tweezers, acid and magnetic resistant



999/B6 1 009990050
999-999A-999B
999C-999D-999E

1002

self-locking round end knurled tool made of stainless steel



L mm 160 2 010020001

1008

long flat knurled nose pliers, slip-proof double layer PVC coated handles



ISO 5745
L mm 160 L1 mm 51,5 5 010080006

1008BM

long flat knurled nose pliers bi-material handles



ISO 5745
L mm 160 L1 mm 51,5 3 010080036

1009

extra-long knurled nose pliers, slip-proof double layer PVC coated handles



ISO 5745
L mm 160 L1 mm 56,5 2 010090006

1009L/A

extra long needle knurled nose pliers, for special operations, slip-proof double layer PVC coated handles



L mm 283 L1 mm 80 2 010090008

1009L/B

curved extra long knurled nose pliers, 45°, for special operations, slip-proof double layer PVC coated handles



L mm	L1 mm	Hand	Code
273	73	2	010090009

1009L/C

bent extra long knurled nose pliers, 90°, for special operations, slip-proof double layer PVC coated handles



L mm	L1 mm	Hand	Code
253	45	2	010090010

1009L/D

extra-long, knurled double swivel nose pliers, slip-proof double layer PVC coated handles



L mm	L1 mm	Hand	Code
342	71	1	010090058

1009L/DP

curved extra-long knurled double swivel nose pliers, 45°, slip-proof double layer PVC-coated handles



L mm	L1 mm	Hand	Code
336	66	1	010090059

1010

long round knurled nose pliers, slip-proof double layer PVC coated handles

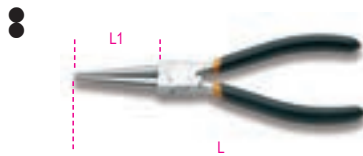

ISO 5745

L mm	L1 mm	Hand	Code
160	51,5	2	010100006

1010BM

long round knurled nose pliers, bi-material handles



ISO 5745

L mm	L1 mm	Hand	Code
160	51,5	2	010100036

1031/S4

set of 4 circlip pliers



Code	Hand	Code
1031 180	⊙ 19 ÷ 60 mm	1 010310000
1034 170	⊙ 19 ÷ 60 mm	
1036 175	● 19 ÷ 60 mm	
1038 175	● 19 ÷ 60 mm	

1032

internal circlip pliers, straight pattern, PVC-coated handles



UNI 7914 DIN 5256

L mm	Ø mm	Hand	Code
140x0,9	8÷12	5	010320013
140x1,3	12÷25	5	010320014
180	19÷60	5	010320017
225	40÷100	3	010320021
300	85÷200	2	010320028

1033

internal circlip pliers, bent pattern, 45° PVC-coated handles



UNI 7914 DIN 5256

L mm	Ø mm	Hand	Code
140x0,9	8÷12	5	010330013
140x1,3	12÷25	5	010330014
180	19÷60	5	010330017
225	40÷100	3	010330021

1034

internal circlip pliers, bent pattern, 90° PVC-coated handles



UNI 7914 DIN 5256

L mm	Ø mm	Hand	Code
130x0,9	8÷12	5	010340013
130x1,3	12÷25	5	010340014
170	19÷60	5	010340017
210	40÷100	3	010340021
290	85÷200	2	010340028

1034L

90° curved long nose pliers for elastic safety rings for holes, PVC-coated handles



L mm	Ø mm	Hand	Code
190	40÷100	2	010340320

1036

external circlip pliers, straight pattern, PVC-coated handles



UNI 7915 DIN 5254

L mm	Ø mm	Hand	Code
140x0,9	3÷10	5	010360013
140x1,3	10÷25	5	010360014
175	19÷60	5	010360017
225	40÷100	3	010360021
300	85÷200	2	010360028

1037

external circlip pliers, bent pattern, 45° PVC-coated handles



UNI 7915 DIN 5254

L mm	∅ mm		
140x0,9	3÷10	5	010370013
140x1,3	10÷25	5	010370014
175	19÷60	5	010370017
225	40÷100	3	010370021

1038

external circlip pliers, bent pattern, 90° PVC-coated handles



UNI 7915 DIN 5254

L mm	∅ mm		
135x0,9	3÷10	5	010380013
135x1,3	10÷25	5	010380014
175	19÷60	5	010380017
220	40÷100	3	010380021
300	85÷200	2	010380028

1039

straight point pliers for internal and external circlips PVC-coated handles



L mm	∅ mm	∅ mm	
150	10÷15	6÷25	2 010390015

1558/C4

internal and external snap ring tool, screw-operated

square drive allows a high force to be applied in both operating conditions
Supplied tips:
∅ 2.5-3-3.5 mm



	∅ mm	∅ mm	
1558/C4	5,5 ÷ 77	5,5 ÷ 77	1 015580100

330x220x50 mm - 900 g

1044

slip joint pliers overlapping joint PVC-coated handles

· 9-position model



ISO 8976

L mm	A max mm	L1 mm	
250	48	39	5 010440250

1044F

slip joint pliers overlapping joint PVC-coated handles

· 9-position model



ISO 8976

L mm	A max mm	L1 mm	
250	48	39	5 010440015

1046

slip joint pliers overlapping rack-type joint PVC-coated handles

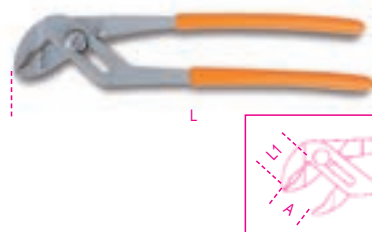

ISO 8976

L mm	A max mm	L1 mm	
240	28	33	5 010460240
400	107	55	1 010460400

1047

slip joint pliers, push button adjustment

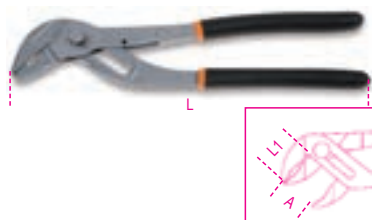

L mm	A max mm	L1 mm	
180	30	29	2 010470180
240	36	35	2 010470240
300	50	48	1 010470300

1047BM

slip joint pliers, push button adjustment, bimaterial handles

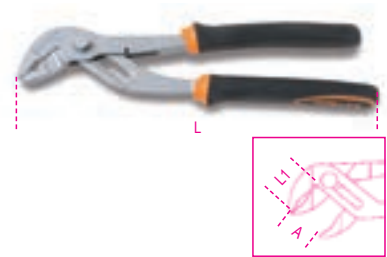

L mm	A max mm	L1 mm	
240	36	35	2 010470340

1048

Slip joint pliers, boxed joints, slip-proof double layer PVC coated handles

· 9-position model

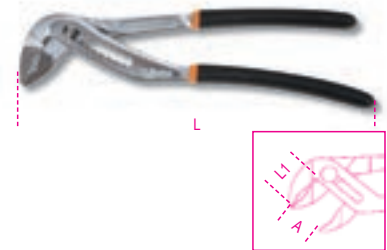

ISO 8976

L mm	A max mm	L1 mm	
175	30	29	3 010480010
250	48	39	5 010480015
300	56	47	2 010480020

1048BM

slip joint pliers, boxed joint, bimaterial handles

· new 9-position model

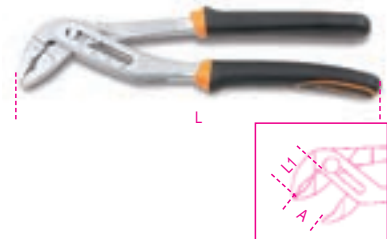

ISO 8976

L mm	A max mm	L1 mm	
250	48	39	3 010480215

Beta

1048V

slip joint pliers boxed joints, orange lacquered

· new 9-position model

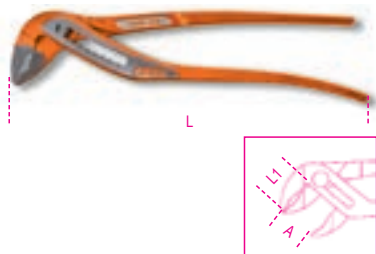

ISO 8976

L mm	A max mm	L1 mm		
175	30	29	3	010480110
250	48	39	5	010480115
300	56	47	2	010480120

1050

double adjustment self-locking pliers

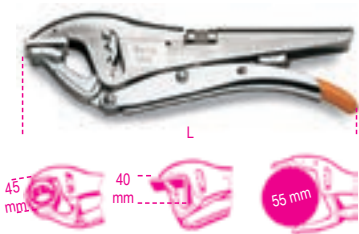

L mm			
220	2	010500022	

1051

double adjustment self-locking pliers long jaws

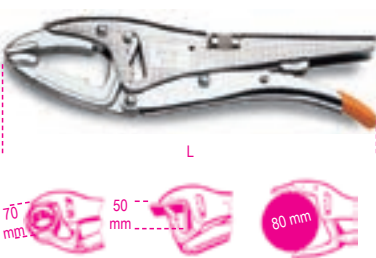

L mm			
255	2	010510025	

1051GM

double adjustment self-locking pliers, floating jaw

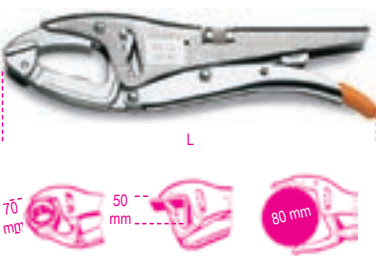

L mm			
255	2	010510250	

1051L

large-capacity double adjustment self-locking pliers

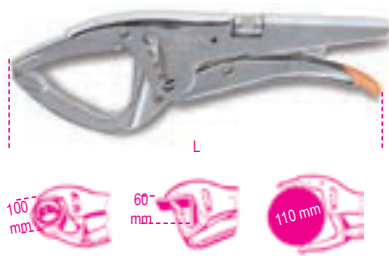

L mm			
270	2	010510100	

1051XL

large-capacity double adjustment self-locking pliers, extra-long jaws



L mm			
270	2	010510140	

1052

adjustable self-locking pliers, concave jaws

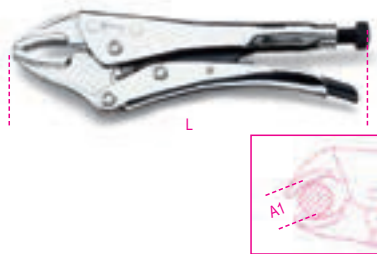

L mm	A1 max mm		
140	22	3	010520014
190	36	3	010520019
240	42	3	010520024
300	55	2	010520030

1053

adjustable self-locking pliers, floating jaw

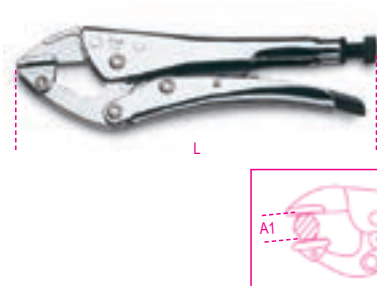

L mm	A1 max mm		
240	35	2	010530024

1054

adjustable self-locking pliers, straight jaws



L mm	A1 max mm		
235	40	2	010540022

1055

adjustable self-locking pliers, curved jaws

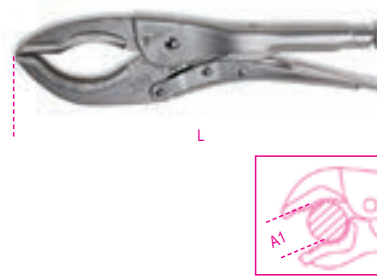

L mm	A1 max mm		
270	75	2	010550027

1056

adjustable self-locking pliers for refrigeration technicians

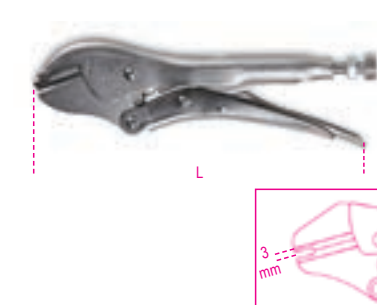

L mm			
195	2	010560017	

1057A

automatic self-locking pliers with adjustable force



L mm			
240	2	010570124	

1058

adjustable self-locking pliers,
long jaws

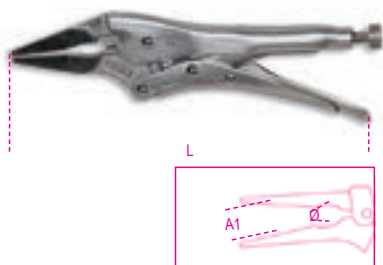

L mm	A1 max mm	Ø max mm		
175	34	26	2	010580017
225	46	31	2	010580025

1060

adjustable self-locking pliers,
fork-type jaws

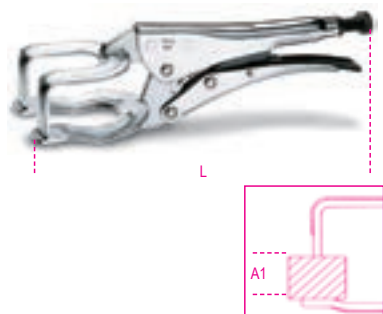

L mm	A1 max mm		
200	50	2	010600020
280	80	2	010600028

1061

adjustable self-locking pliers,
fork-type jaws

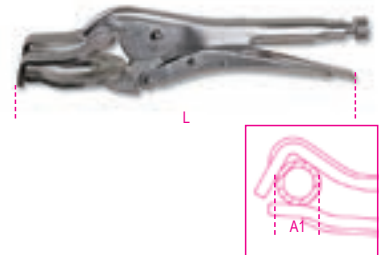

L mm	A1 max mm		
275	80	2	010610027

1062

adjustable self-locking pliers
with C-shaped jaws

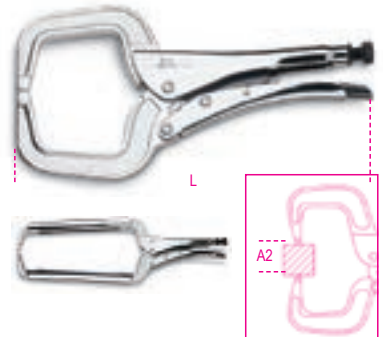

L mm	A2 max mm		
170	50	2	010620017
290	120	2	010620029
460	255	1	010620045

1062AL

adjustable self-locking pliers,
aluminium C-shaped jaws

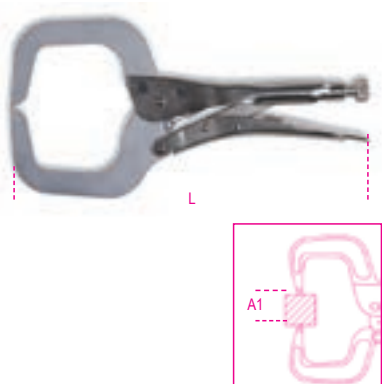

L mm	A1 max mm		
275	88	2	010620327

1062GM

adjustable self-locking pliers
with floating C-shaped jaws

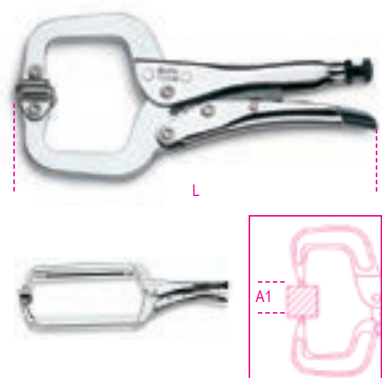

L mm	A1 max mm		
170	45	2	010620217
290	88	2	010620229
460	255	1	010620245

1063

adjustable self-locking pliers
for tinsmiths

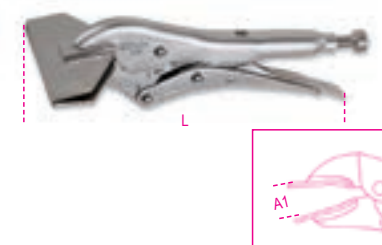

L mm	A1 max mm		
200	31	2	010630021

1064

adjustable self-locking pliers with chain

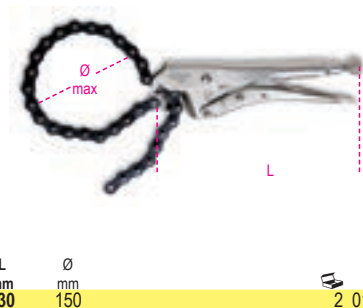

L mm	Ø mm		
230	150	2	010640023

1065F

hand punch steel punch and matrix

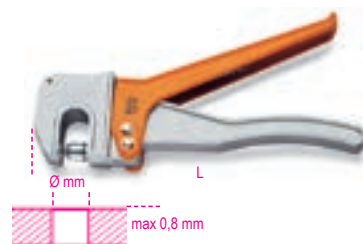

Ø mm	L mm		
5	228	1	010650010
6	228	1	010650015

1065P

hand crimper steel matrix

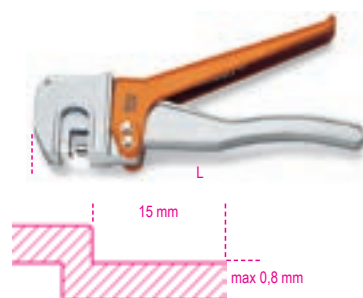

L mm			
228	1	010650020	

1077

straight wide blade tinsmith's pliers,
PVC-coated handles



L mm	A mm	L1 mm		
280	60	53	1	010770026

1078

curved wide blade tinsmith's pliers,
45° PVC-coated handles



L	A	L1		
mm	mm	mm		
280	60	77	1	010780026

1080D

diagonal flush cutting nippers,
slip-proof double layer PVC coated handles

For cutting plastic



α	L	L1		
°	mm	mm		
15°	160	22	3	010800015
45°	160	22	3	010800045

1081

semi-flush cutting nippers,
slip-proof double layer PVC
coated handles

• For micro-mechanics and heavy-duty electronics



L	L1		
mm	mm		
125	16	3	010810130

1082

diagonal cutting nippers,
slip-proof double layer PVC coated handles



L	L1	$\#$		
mm	mm	mm		
140	20	1,6	5	010820004
160	22	1,6	5	010820006

1082BM

diagonal cutting nippers,
bi-material handles



L	L1	$\#$		
mm	mm	mm		
140	20	1,6	3	010820034
160	22	1,6	3	010820036

1084

heavy duty diagonal cutting nippers,
slip-proof double layer PVC coated handles



L	L1	$\#$		
mm	mm	mm		
140	20	1,4	5	010840004
160	22	1,6	5	010840006
180	25	1,8	3	010840008
200	28	2,0	3	010840010

1084BM

heavy duty diagonal cutting nippers
bi-material handles



L	L1	$\#$		
mm	mm	mm		
140	20	1,4	3	010840034
160	22	1,6	3	010840036
180	25	1,8	3	010840038
200	28	2,0	3	010840040

1088

heavy duty end cutting nippers,
slip-proof double layer PVC coated handles



L	L1	$\#$		
mm	mm	mm		
160	9	1,6	2	010880006
200	11	2,0	2	010880010

1088BM

heavy duty end cutting nippers,
bi-material handles



L	L1	$\#$		
mm	mm	mm		
160	9	1,6	2	010880036
200	11	2,0	2	010880040

UNI/ISO 5748

L	L1	$\#$		
mm	mm	mm		
160	9	1,6	2	010880036
200	11	2,0	2	010880040

1092V

toggle lever assisted end cutting nippers



L	L1	$\#$		
mm	mm	mm		
180	8	2,0	2	010920280
200	9	2,5	2	010920310

UNI/ISO 5748

L	L1	$\#$		
mm	mm	mm		
180	8	2,0	2	010920280
200	9	2,5	2	010920310

1094V

toggle lever assisted
diagonal cutting nippers



L	L1	$\#$		
mm	mm	mm		
200	23	2,5	2	010940200

UNI/ISO 5749

L	L1	$\#$		
mm	mm	mm		
200	23	2,5	2	010940200

1095N

toggle lever assisted
diagonal cutting nippers



L	L1	$\#$		
mm	mm	mm		
195	26	1,6	2	010950010

1096

carpenter's pincers



ISO 9243

L	L1		
mm	mm		
160	21	5	010960016
200	23	5	010960020
250	30	5	010960025

1098

construction worker's pincers



ISO 9242 DIN 5242

L	L1		
mm	mm		
190	12	5	010980190
220	13	5	010980220
250	15	5	010980250
280	18	5	010980280

1098PL

construction worker's pincers,
PVC coated handles



ISO 9242 DIN 5242

L	L1		
mm	mm		
220	13	5	010980320
250	15	5	010980350
280	18	5	010980380

1101

bolt cutter phosphatized blades
and rubber grip handles



L	L		
mm	mm		
300	12	2	011010030
350	14	2	011010035
450	18	1	011010045
600	24	1	011010060
750	30	1	011010075
900	36	1	011010090

L	R = 80	R = 140	g	
mm	Kgf=mm ²	Kgf=mm ²		
	Ø mm	Ø mm		
300	5	4	745	
350	6	5	1043	
450	7	6	1537	
600	9	7	2540	
750	11	8	3870	
900	12	9	6170	

1101R

spare blades for item 1101



mm	1101		
300	300	1	011010130
350	350	1	011010135
450	450	1	011010145
600	600	1	011010160
750	750	1	011010175
900	900	1	011010190

1102

bolt cutters, small series

Cutting capacity
R= \approx 80 Kgf/mm²



L	mm		
230	4	3	011020020

1104

heavy-duty cutters for flexible steel cables,
handles with thermoplastic grips

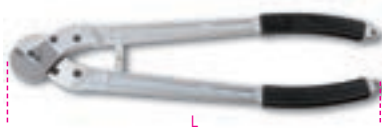

L	mm	mm		
420	12	1	011040004	
600	16	1	011040006	

1104R

spare blades for item 1104



mm			
420		1	011040014
600		1	011040016

Beta

1105

punches made from burnished steel

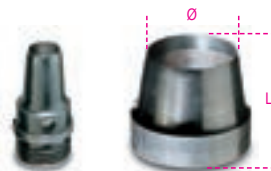

D	L		
mm	mm		
2	27	1	011050002
3	27	1	011050003
4	27	1	011050004
5	27	1	011050005
6	27	1	011050006
7	27	1	011050007
8	27	1	011050008
9	27	1	011050009
10	27	1	011050010
12	27	1	011050012
14	27	1	011050014
16	27	1	011050016
18	27	1	011050018
20	27	1	011050020
22	32	1	011050022
24	32	1	011050024
26	32	1	011050026
28	32	1	011050028
30	32	1	011050030
32	37	1	011050032
34	37	1	011050034
36	37	1	011050036
38	37	1	011050038
40	37	1	011050040
42	42	1	011050042
44	42	1	011050044
46	42	1	011050046
48	42	1	011050048
50	42	1	011050050

1105T30

shank for punches 1105,
3 to 30 mm



L	mm		
155		1	011050201

1105T50

shank for punches 1105
2 to 50 mm



L	mm		
155		1	011050202

Beta

1105AD-50

shank adaptor for item 1105T50



∅			
mm			
57	1	011050210	

1105/C15T

assortment of 15 punches, 3 to 30 mm



1105C/15T		1	011050251
-----------	--	---	-----------

1105	3 - 4 - 6 - 8 - 10 - 12 - 14 - 16 - 18 - 20 - 22 - 24 - 26 - 28 - 30 mm
------	---

1105T30	
---------	--

230x190x50 mm

1105/C29T

assortment of 29 punches, 2 to 50 mm



1105C/29T		1	011050252
-----------	--	---	-----------

1105	2 - 3 - 4 - 5 - 6 - 7 - 8 - 9 - 10 - 12 - 14 - 16 - 18 - 20 - 22 - 24 - 26 - 28 - 30 - 32 - 34 - 36 - 38 - 40 - 42 - 44 - 46 - 48 - 50 mm
------	---

1105T50	
1105AD-50	

325x280x55 mm

1112

tin snips straight wide blades

Cutting capacity
R = ± 60 Kg/mm²



L	L1	S	A	
mm	mm	mm	mm	
200	50	0,5	26	2 011120020
250	62	0,8	33	2 011120025
300	76	1,0	37	2 011120030
375	76	1,2	44	1 011120037

1114

tin snips straight narrow blades

R = 60 Kg/mm²



L	L1	S	A	
mm	mm	mm	mm	
250	58	0,5	15	1 011140265
350	76	1	22	1 011140340

1118

safety strap cutting shears

Fe = normal steel
Inox = stainless steel



L	L1	Fe	Inox	
mm	mm	S mm	S mm	
310	42	1	0,8	2 011180001

1120A

hand nibbler

Fe = normal steel



L	Fe	
mm	S mm	
280	1,2	1 011200101

1120ARL - ARG

spare parts for item 1120A



1120ARL	1	011200110
1120ARG	1	011200120

1122

compound leverage shears, straight blades

Inox = stainless steel



L	L1	Inox	A	
mm	mm	S mm	mm	
250	40	1	24	2 011230020

1123

right cut compound leverage shears, curved blades

Inox = stainless steel



L	L1	Inox	A	
mm	mm	S mm	mm	
250	40	1	24	2 011230020

1124

left cut compound leverage shears, curved blades

Inox = stainless steel



L	L1	Inox	A	
mm	mm	S mm	mm	
250	40	1	24	2 011240020

1125

compound leverage shears for straight and right cuts

Inox = stainless steel



L	L1	Inox	A	
mm	mm	S mm	mm	
250	35	1	46	2 011250020

1126

compound leverage shears for straight and left cuts

Inox = stainless steel



L	L1	Inox	A	
mm	mm	S mm	mm	
250	35	1	46	2 011260020

1122 - 1125MOL



1122 MOL	1122 - 1124	1	011220010
1123 MOL	1123	1	011230010
1125 MOL	1125 - 1126	1	011250040

1127

telephone engineer's scissors,
straight blades



L mm	L1 mm		
150	35	5	011270001

1128BAX

Double-acting electricians' scissors,
with milling profiles in DLC-coated stainless
steel

Double-acting cutting: a special cam on the fulcrum allows the blades to run lengthwise, which results in increased cutting power while closing the blades.

Profile and mill: designed to enlarge holes on plastic, from 13 mm to 25 mm.

DLC coating: DLC (diamond-like carbon) is an innovative carbon-based coating: the high hardness and low coefficient of friction arise from the simultaneous presence of carbon on the surface in the form of graphite, and diamond.

- High blade surface hardness (resistance to abrasion and wear)
- Low coefficient of friction (smoothness and anti-adherence)
- Anti-loose eccentric pin
- Large handles with pipe throttling grooves
- With articulated plastic case
- Patented

PATENTED



L mm	L1 mm	$\frac{\pi}{4}$ mm ²	
150	50	50	5 011280088

1128BCX

electrician's scissors,
straight stainless steel blades,
with microteeth, cable cutting groove and
crimping pliers for tube terminals

tube terminal crimping: 1+4 mm²
in jointed plastic case



L mm	L1 mm	$\frac{\pi}{4}$ mm ²	
155	55	50	5 011280080

1128BMX

electrician's scissors,
straight stainless steel blades,
with microteeth



L mm	L1 mm		
147	58,2	5	011280051

1128BMX/F

articulated plastic case
for item 1128BMX



1128BMX/F	1	011280059
-----------	---	-----------

1128BSX

electrician's scissors
with graduated milling profiles with case



L mm	L1 mm		
148	58,2	5	011280061

1128FX

electrician's scissors,
straight stainless steel blades,
with microteeth, cable cutting groove and
crimping pliers for tube terminals

- Articulated belt hook case
- Bimaterial handles
- Anti-loose pin



L mm	L1 mm	$\frac{\pi}{4}$ mm ²	
145	52	50	5 011280090

1128FXS

electrician's scissors with graduated milling
profiles, straight stainless steel blades, with
microteeth, cable cutting groove and crimping
pliers for tube terminals

- Articulated belt hook case
- Bimaterial handles
- Anti-loose pin

- Profile and mill: designed to enlarge holes on plastic, from 13 to 21 mm.



L mm	L1 mm	$\frac{\pi}{4}$ mm ²	
145	52	50	5 011280095

1128BM

electrician's scissors, straight blades



L mm	L1 mm		
145	50	5	011280000

1129BM

electrician's scissors, curved blades



L mm	L1 mm		
145	44	5	011290000

Beta

1130BMX

Multiuse scissors, straight stainless steel blades, with microteeth



L mm	L1 mm		
185	60	1	011300002

1131CK

Kevlar® and fibre optics scissors



L mm	L1 mm		
203	75	1	011310001

1132

cable cutters for insulated copper and aluminium cables, slip-proof double layer PVC coated handles



UNI 8791			
L ~	mm	mm ²	
170	14	50	2 011320107
230	18	95	2 011320113

1132BM

cable cutters for insulated copper and aluminium cables, bi-material handles



UNI 8791			
L ~	mm	mm ²	
170	14	50	2 011320137
230	18	95	2 011320143

1133

cable cutter for copper cables, flexible

up to 325 mm²



L ~	mm	mm ²	
600	32	300	1 011330001

1133RL

spare blades for item 1133



1133RL	1	011330011
--------	---	-----------

1134

ratchet cable cutters burnished finish, plastic handles



L mm	mm	mm ²	
260	35	400	1 011340032

1134RL

spare blade for item 1134



1134RL	1	011340132
--------	---	-----------

1134A

ratchet cable cutters burnished finish, plastic handles



L mm	mm	mm ²	
240	45	500	1 011340045

1134A/RL

spare blade for item 1134A



1134A/RL	1	011340145
----------	---	-----------

1136

cable cutter for steel cables

Cutting capacity
Ø 5 mm for cable R ≤ 160 Kg/mm²
Ø 4 mm for mild steel bolts

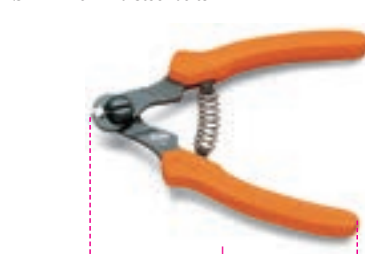

L mm		
165	2	011360001

1142BM

wire stripping pliers, bi-material handles



L mm	mm ²	mm	
160	0,5÷6	0-2,8	3 011420036

1143

wire stripping pliers



L ~	mm ²	mm	
165	1÷6	1-3,2	1 011430001

1143R

spare blades for item 1143

1143R	1	011430011
-------	---	-----------



1144D

cable stripping tool



L	mm ²	mm	
170	4,5÷240	2,5-18	1 011440010

1144D/RG

spare hook for item 1144D



1144D/RG	1	011440012
----------	---	-----------

1144D/RL

spare blades for item 1144D

1144D/RL	1	011440011
----------	---	-----------

1144G

cable stripping tool

with adjustable blade for transverse and longitudinal cuts



L	mm ²	mm	
140	6÷75	2.8-12	1 011440004

1144G/RL

spare blade for item 1144G



1144G/RL	1	011440005
----------	---	-----------

1148A

wire stripping pliers, self-adjusting, with cutting device

cutting capacity
≠ 10 mm² (8 AWG) flexible wires
≠ 1,5 mm² (16 AWG) sturdy wires



L	mm ²	mm	
190	0,02÷10	0-4	1 011480100

1148A/R

spare blades for item 1148A



1148A/R	1	011480102
---------	---	-----------

1148B

wire stripping pliers, self-adjusting, with cutting device

cutting capacity
≠ 10 mm² (8 AWG) flexible wires
≠ 1,5 mm² (16 AWG) sturdy wires



L	mm ²	mm	
190	4÷16	2-5	1 011480200

1148B/R

spare blades for item 1148B



1148B/R	1	011480202
---------	---	-----------

1149F

front wire stripping pliers with cutting blade, self-adjusting



L	mm ²		
175	0,2 ÷ 6		1 011490010

1150

combination pliers bright chrome-plated, slip-proof double layer PVC coated handles



ISO 5746

L	L1	mm	
160	37	1,6	5 011500006
180	41	1,8	5 011500008
200	45	2,0	5 011500010
220	50	2,0	2 011500012

1150HPC

heavy duty combination pliers with integrated cutting edges and decentralized pin
matt chrome plated finish
bi-material handles

open joint

integrated cutting edge

steel: M2

thickness: 0.20 mm

angle: 62°

hardness: 63÷65 HRC



ISO 5746

L	L1	mm	
180	39	1,8	2 011500618

1150BM

combination pliers bright chrome-plated, bi-material handles



ISO 5746

L	L1	mm	
160	37	1,6	3 011500036
180	41	1,8	3 011500038
200	45	2,0	3 011500040
220	50	2,0	2 011500042

1153

adjustable pliers, two positions, PVC-coated handles



UNI ISO 9343

L	L1	mm	
200	34		2 011530120

1162

extra long flat knurled nose pliers, slip-proof double layer PVC coated handles



ISO 5745

L	L1	mm	
160	58	1,6	5 011620006
200	86	1,6	5 011620010

1162BM

extra long flat knurled nose pliers
bi-material handles



ISO 5745

L	L1	mm		
mm	mm	mm		
160	58	1,6	3	011620036
200	86	1,6	3	011620040

1164

extra long bent flat knurled nose pliers,
slip-proof double layer PVC coated handles



ISO 5745

L	L1	mm		
mm	mm	mm		
160	54	1,6	5	011640006
200	76	1,6	5	011640010

1164BM

extra long bent flat knurled nose pliers,
bi-material handles



ISO 5745

L	L1	mm		
mm	mm	mm		
160	54	1,6	3	011640036
200	76	1,6	3	011640040

1166

extra long needle knurled nose pliers,
slip-proof double layer PVC coated handles



ISO 5745

L	L1	mm		
mm	mm	mm		
160	56	1,6	5	011660006
200	76	1,6	5	011660010

1166BM

extra long needle knurled nose pliers,
bi-material handles



ISO 5745

L	L1	mm		
mm	mm	mm		
160	56	1,6	3	011660036
200	76	1,6	3	011660040

1168

extra long bent needle knurled nose pliers,
slip-proof double layer PVC coated handles



ISO 5745

L	L1	mm		
mm	mm	mm		
160	54	1,6	5	011680006
200	76	1,6	5	011680010

1168BM

extra long bent needle knurled nose pliers,
bi-material handles



ISO 5745

L	L1	mm		
mm	mm	mm		
160	54	1,6	3	011680036
200	70	1,6	3	011680040

1171BM

smooth, flat short nose pliers
bi-material handles



ISO 9655

L	L1	A	B		
mm	mm	mm	mm		
~130	18	12	8	2	011710101

1172BM

smooth, flat long nose pliers
bi-material handles

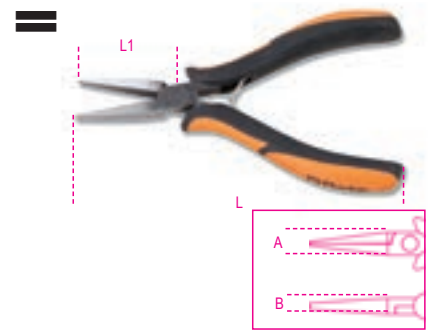

ISO 9655

L	L1	A	B		
mm	mm	mm	mm		
~140	40	12	8	2	011720101

1172BM/P

smooth, flat bent long nose pliers
bi-material handles



L	L1	A	B		
mm	mm	mm	mm		
~140	38	12	13	2	011720102

1173BM

round short nose pliers
bi-material handles



ISO 9655

L	L1	A	B		
mm	mm	mm	mm		
~125	22	12	8	2	011730101

1175BM

smooth half-round short nose pliers
bi-material handles

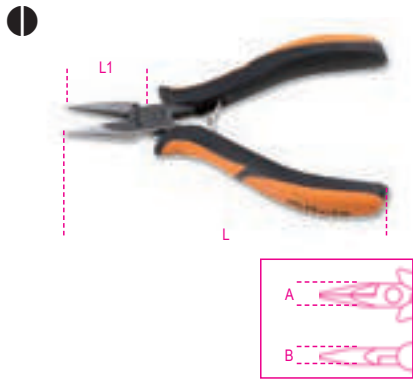

ISO 9655

L	L1	A	B
mm	mm	mm	mm
140	29	12	8

1177BM

smooth half-round long nose pliers
bi-material handles

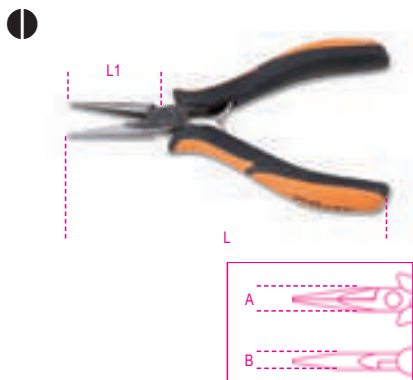

ISO 9655

L	L1	A	B
mm	mm	mm	mm
140	38	12	8

1177BM/Z

half-round long knurled nose pliers
bi-material handles

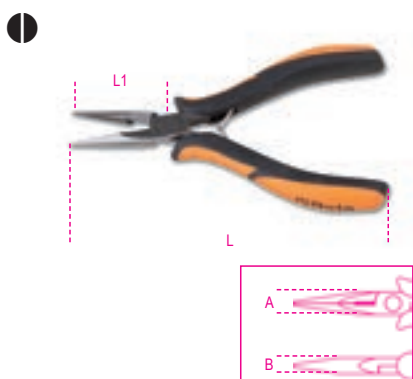

ISO 9655

L	L1	A	B
mm	mm	mm	mm
140	39	12	8

1178BM

smooth half-round long needle nose pliers
bi-material handles

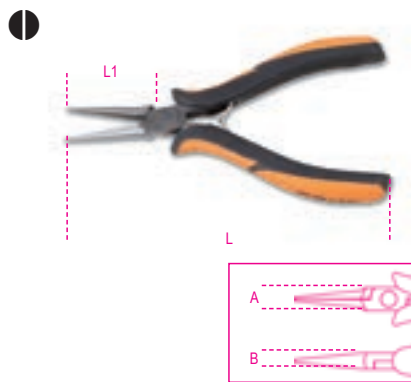

ISO 9655

L	L1	A	B
mm	mm	mm	mm
140	37	12	8

1178BM/P

smooth half-round long bent
needle nose pliers
bi-material handles

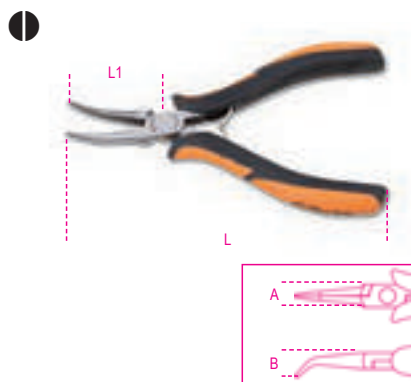

L	L1	A	B
mm	mm	mm	mm
140	36,5	12	12

Beta

Copper cutting nippers.
For heavier duty jobs see item 1081

1182BM

diagonal semi-flush cutting nippers,
slim tips
bi-material handles



ISO 9654

L	L1	A	Cu
mm	mm	mm	mm
120	11	10	1

1183BM

diagonal semi-flush cutting nippers,
rounded tips
bi-material handles



ISO 9654

L	L1	A	Cu
mm	mm	mm	mm
120	11	10	1

1184BM

diagonal flush cutting nippers,
rounded tips
bi-material handles



ISO 9654

L	L1	A	Cu		
mm	mm	mm	mm		
120	11	10	1	2	011840101
130	13	12,5	1,25	2	011840102

1185BM

diagonal flush cutting nippers,
slim tips
bi-material handles



ISO 9654

L	L1	A	Cu		
mm	mm	mm	mm		
120	11	10	1	2	011850101
130	13	12,5	1,25	2	011850102

1186BM

diagonal flush cutting nippers,
slim tapering tips
bi-material handles



ISO 9654

L	L1	A	Cu		
mm	mm	mm	mm		
120	11	10	1	2	011860101
130	13	12,5	1,25	2	011860102

1188BM

diagonal axial cutting nippers
bi-material handles



ISO 9654

L	L1	A	Cu		
mm	mm	mm	mm		
125	12	12	1,25	2	011880101
130	17	15	2	2	011880102

1190BM

end semi-flush cutting nippers
bi-material handles



ISO 9654

L	L1	A	Cu		
mm	mm	mm	mm		
120	12	12	1,25	2	011900113

1191BM

end flush oblique cutting nippers
bi-material handles



ISO 9654

L	L1	A	Cu		
mm	mm	mm	mm		
130	8	12	0,8	2	011910101

1191BM/L

end flush long oblique cutting nippers
bi-material handles



ISO 9654

L	L1	A	Cu		
mm	mm	mm	mm		
130	18	12	1	2	011910110

1191R/5-M

spare spring kit for pliers and nippers for
electronics, 5 pairs (items: 1171...1191)

1191R/5-M	1	011910995
-----------	---	-----------

1200MS

magnetizer/demagnetizer

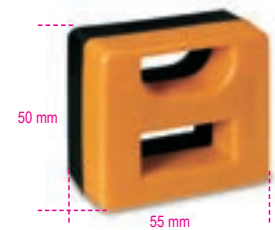

1200MS	5	012000000
--------	---	-----------

1201

screwdrivers for slotted head screws



ISO 2380

SxAxL	L1	Ø		
mm	mm	mm		
0,4x2,5x50	146	2,5	5	012010003
0,4x2,5x75	166	2,5	5	012010006
0,5x3x75	171	3,0	5	012010009
0,5x3x100	196	3,0	5	012010012
0,6x3,5x75	171	3,5	5	012010018
0,6x3,5x100	196	3,5	5	012010021
0,8x4x100	196	4,0	5	012010030
0,8x4x125	221	4,0	5	012010033
0,8x4x150	246	4,0	5	012010036
1,0x5,5x100	209	5,0	5	012010039
1,0x5,5x125	234	5,0	5	012010040

SxAxL mm	L1 mm	Ø mm		
1,0x5,5x150	259	5,0	5	012010042
1,2x6,5x100	220	6,0	5	012010048
1,2x6,5x125	234	6,0	5	012010050
1,2x6,5x150	270	6,0	5	012010051
1,2x8x150	282	8,0	3	012010057
1,2x8x200	332	8,0	3	012010060
1,6x10x200	332	9,5	3	012010066



SxAxL mm	L1 mm	Ø mm		
1201/S6			1	012010206
0,5x3x75-0,6x3,5x100				
0,8x4x100-1,0x5,5x100				
1,2x8x150-1,6x10x200 mm				

1201N
screwdrivers for slotted head screws,
extra-short series



ISO 2380

SxAxL mm	L1 mm	Ø mm		
0,8x4x30	86,5	4	3	012010103
1,2x6,5x30	86,5	6	3	012010106

1201DZ
screwdriver for Dzus® head screws



L mm	L1 mm		
1201DZ	53	173	2 012010501

1202
screwdrivers for cross head
Phillips® screws



UNI/ISO 8764

PHxDxL mm	L1 mm		
0x3x60	156	5	012020003
0x3x100	200	5	012020006
1x4,5x80	189	5	012020009
1x4,5x120	229	5	012020012
2x6x100	220	5	012020018
2x6x150	270	5	012020021
3x8x150	282	3	012020024
4x9,5x200	332	3	012020027



PHxDxL mm	L1 mm		
1202/S4		1	012020204
PH0x3x60-PH1x4,5x120			
PH2x6x150-PH3x8x150 mm			

1202N
screwdrivers
for cross head Phillips® screws,
extra-short series



UNI/ISO 8764

PHxDxL mm	L1 mm		
1x4,5x30	86,5	3	012020103
2x6x30	86,5	3	012020106

1202L
screwdrivers for cross head
Phillips® screws, long series



UNI/ISO 8764-1

PHxDxL mm	L1 mm		
0x3x300	400	3	012020303
1x4,5x300	400	3	012020305
1x4,5x400	508	3	012020306
2x6x400	519	3	012020309

1203/D
set of screwdrivers



PHxDxL mm	L1 mm		
1203/D5		1	012030001
1201	0,6x3,5x100-1,0x5,5x150		
1202	1,2x6,5x150 mm		
	PH1x4,5x80-PH2x6x100 mm		

PHxDxL mm	L1 mm		
1203/D7		1	012030007
1201	0,5x3x75-0,8x4x100		
1202	1,0x5,5x100-1,2x6,5x150 mm		
	PH0x3x60-PH1x4,5x80		
	PH2x6x100 mm		

PHxDxL mm	L1 mm		
1203/D8		1	012030008
1201	0,5x3x75-0,8x4x125		
1202	1,0x5,5x150-1,2x6,5x150 mm		
	PH0x3x60-PH1x4,5x80		
	PH2x6x100-PH3x8x150 mm		

PHxDxL mm	L1 mm		
1203/D10N		1	012030019
1201	0,4x2,5x50-0,5x3x75-0,8x4x100-		
	1,0x5,5x150-1,2x6,5x150 mm		
1201N	0,8x4x30 mm		
1202	PH0x3x60-PH1x4,5x80-		
	PH2x6x100 mm		
1202N	PH1x4,5x30 mm		

PHxDxL mm	L1 mm		
1203/D10		1	012030010
1201	0,4x2,5x50-0,5x3x75		
	0,8x4x100-1,0x5,5x100		
1202	1,2x6,5x150-1,2x8x150 mm		
	PH0x3x60-PH1x4,5x80		
	PH2x6x100-PH3x8x150 mm		

PHxDxL mm	L1 mm		
1203/D6		1	012030006
1202	PH1x4,5x80-PH2x6x100 mm		
1204	0,4x2,5x60-0,5x3x100		
	0,8x4x100-1,0x5x125 mm		

PHxDxL mm	L1 mm		
1203/D5PZ		1	012030003
1201	0,5x3x75-0,8x4x125		
	1,0x5,5x150 mm		
1209PZ	PZ1x4,5x80-PZ2x6x100 mm		

1203/S



PHxDxL mm	L1 mm		
1203/S8		1	012030009
1201	2,5x50-3x75-4x100-5,5x125-		
	6,5x150 mm		
1202	PH0x3x60-PH1x4,5x80-		
	PH2x6x100 mm		

PHxDxL mm	L1 mm		
1203/S10		1	012030021
1201	0,4x2,5x50-0,5x3x75		
	0,8x4x125-1,0x5,5x150		
1202	1,2x6,5x150-1,2x8x150 mm		
	PH0x3x60-PH1x4,5x80		
	PH2x6x100-PH3x8x150 mm		



1204

screwdrivers for headless slotted screws



ISO 2380

SxDxL mm	L1 mm		
0,4x2,5x60	156	5	012040003
0,6x3x75	175	5	012040006
0,5x3x100	196	5	012040009
0,8x4x100	196	5	012040012
0,8x4x125	233	5	012040015
1x5x125	234	5	012040018
1x5x150	258	5	012040021
1,2x6,5x150	270	5	012040024



1204/S5
0,4x2,5x60-0,5x3x100
0,8x4x100-1x5x125
1,2x6,5x150 mm

1 012040205

1204L

screwdrivers for headless slotted screws,
long series



ISO 2380

SxAxL mm	L1 mm		
0,5x2,5x200	300	3	012040303
0,5x3x300	400	3	012040306
0,8x4x400	508	3	012040309
1x5x400	508	3	012040315
1,2x6,5x400	519	3	012040318

1205ES

hexagon drivers
with handles



mm	L mm	L1 mm		
1,5	100	200	3	012050315
2	100	200	3	012050320
2,5	100	200	3	012050325
3	100	200	3	012050330
4	100	208	3	012050340
5	100	219	3	012050350
6	125	244	3	012050360
8	150	277	2	012050380



1205ES/S8
1,5-2-2,5-3-4-5-6-8 mm

1 012050408

1207TX

screwdrivers for Torx® head screws,
with handles



	L mm	L1 mm	Ø mm		
T5	50	150	3	5	012070005
T6	60	156	4	5	012070006
T7	60	156	4	5	012070007
T8	60	156	4	5	012070008
T9	60	156	4	5	012070009
T10	80	189	5	5	012070010
T15	80	189	5	5	012070015
T20	100	209	5	5	012070020
T25	100	209	5	5	012070025
T27	100	220	6	5	012070027
T30	100	220	6	5	012070030
T40	130	262	7	2	012070040
T45	130	262	8	2	012070045



1207TX/D7
T6-T8-T10-T15
T20-T25-T30

1 012070207

1208RTX

screwdrivers for Tamper Resistant Torx®
head screws, with handles



	L mm	L1 mm	Ø mm		
T9	60	156	4	5	012080009
T10	80	189	5	5	012080010
T15	80	189	5	5	012080015
T20	100	209	5	5	012080020
T25	100	209	5	5	012080025
T27	100	220	6	5	012080027
T30	100	220	6	5	012080030
T40	130	262	7	2	012080040



1208RTX/D7
T9-T10-T15-T20
T25-T27-T30

1 012080207

1209PZ

screwdrivers for cross head
Pozidriv®-Supadriv® screws



UNI/ISO 8764

PZ	L mm	L1 mm		
0	60	156	5	012090000
1	80	189	5	012090003
2	100	220	5	012090006
3	150	282	3	012090009
4	200	327	3	012090012



1209PZ/S4
PZ0-PZ1-PZ2-PZ3

1 012090204

1209N/PZ

screwdrivers for cross head
Pozidriv®-Supadriv® screws,
extra-short series



ISO 8764

PZ	L mm	L1 mm		
1	30	87	3	012090103
2	30	87	3	012090106



1229LP

micro-screwdrivers
for headless slotted screws

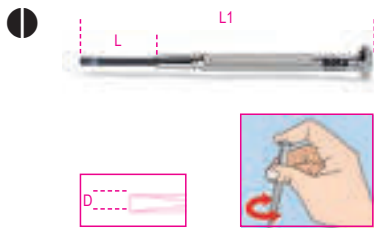

D mm	L mm	L1 mm		
1,0	17	75	5	012290210
1,2	21	85	5	012290212
1,4	21	89	5	012290214
1,8	23	94	5	012290218
2,0	23	98	5	012290220
2,4	26	103	5	012290224
3,0	28	108	5	012290230



1229LP/A6
1,2-1,4-1,8-2-2,4-3 mm
1 012290300

1229PH

micro-screwdrivers for cross head
Phillips® screws

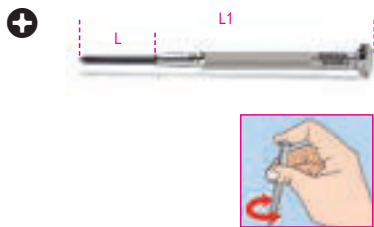

PH	L mm	L1 mm		
0	26	102	5	012290250
1	29	107	5	012290251

1229LPH/A6

set of 6 micro-screwdrivers
items 1229LP-1229PH



1229LPH/A6
1 012290310
1229LP 1,4-2,0-2,4-3 mm
1229PH PH0-PH1

1236B

offset screwdrivers
for slotted head screws

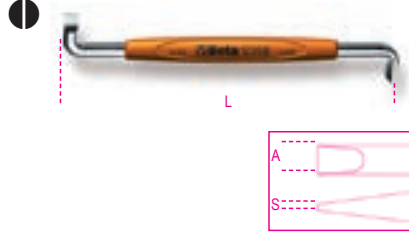

UNI 7079 DIN 5200

SxA mm	L mm		
0,8x4	100	5	012360201
1x5,5	125	5	012360202
1,2x8	150	5	012360204

1238B

offset screwdrivers
for cross head Phillips® screws



UNI 7083 DIN 5208

PH	L mm		
1-2	125	5	012380201
3-4	200	5	012380203

1241

screwdrivers with steel head for slotted head
screws

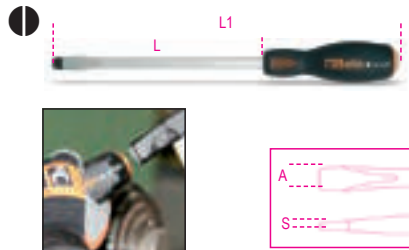

ISO 2380

SxAxL mm	L1 mm		
1x5,5x100	202	5	012410039
1,2x6,5x125	240	5	012410050
1,2x8x150	268	3	012410057
1,6x10x200	325	2	012410066

1242

screwdrivers with steel head for cross head
Phillips® screws

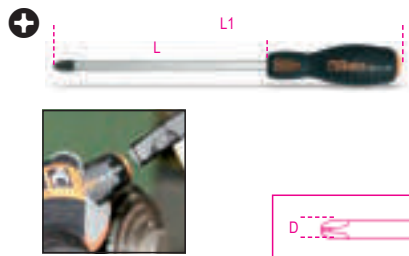

UNI/ISO 8764

PHxDxL mm	L1 mm		
1x4,5x100	202	5	012420209
2x6x100	215	5	012420218
3x8x150	268	3	012420221
4x11x200	325	2	012420224

1243/D7

Set of 7 screwdrivers with steel heads



1243/D7			
1241	1x5,5x100-1,2x6,5x125 1,2x8x150-1,6x10x200 mm	5	012430017
1242	PH1x4,5x100-PH2x6x100 PH3x8x150 mm	5	012430017

1250

screwholding screwdrivers
for slotted head screws

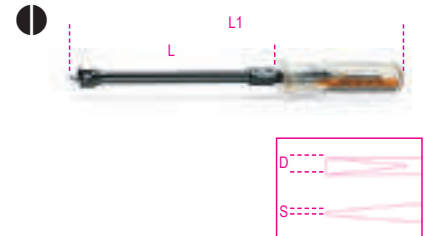

SxDxL mm	L1 mm		
0,5x3x125	190	5	012500030
0,6x4x125	225	5	012500040
0,7x5x150	255	5	012500050

1251

screwholding screwdrivers
for cross head Phillips® screws



PHxDxL mm	L1 mm		
0x4x125	225	5	012510000
1x5x150	255	5	012510010
2x6x175	280	5	012510020

1252/S5



1252/S5			
1250	0,5x3x125-0,6x4x125 0,7x5x150 mm	5	012520001
1251	PH1x5x150-PH2x6x175 mm	5	012520001

1253

mains testing screwdriver 150/250V

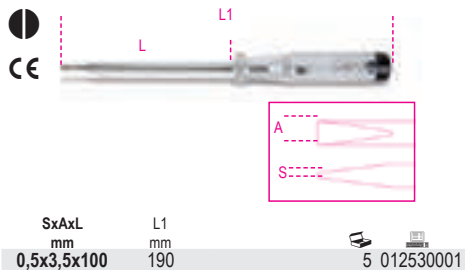

SxAxL mm	L1 mm	5	012530001
0,5x3,5x100	190		

1253A

mains testing screwdriver 125/250V, double insulation

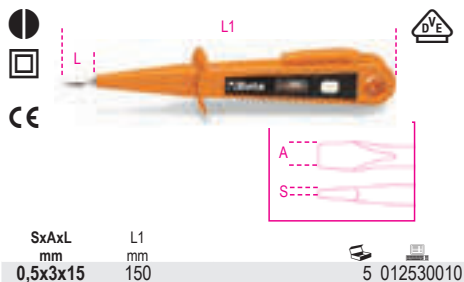

SxAxL mm	L1 mm	5	012530010
0,5x3x15	150		

1254

circuit testing screwdriver 6-24V

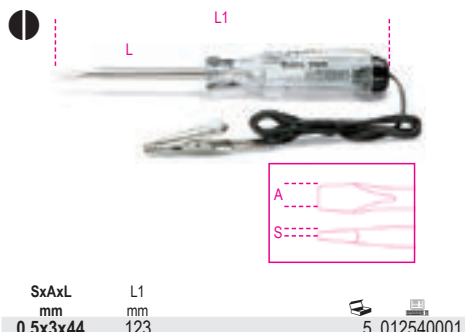

SxAxL mm	L1 mm	5	012540001
0,5x3x44	123		

1256/C36-2

microscrewdriver with 36 interchangeable 4-mm bits and magnetic extension



1256/C36-2	1	012560100

	1256TX	T3 - T4 - T5 - T6 - T7 T8 - T9 - T10 - T15
	1256RTX	T6 - T7 - T8 - T9 - T10
	1256LP	0,8 - 1,2 - 1,5 - 1,8 - 2 - 2,5 3 - 3,5 - 4 mm
	1256PE	0,7 - 0,9 - 1,3 - 1,5 - 2 mm
	1256PH	PH000 - PH00 - PH0 - PH1
	1256PZ	PZ000 - PZ00 - PZ0 - PZ1
	1256/20	
	1256/30	

130x60x35 mm - 200 g

1256LP

4-mm bits for slotted head screws

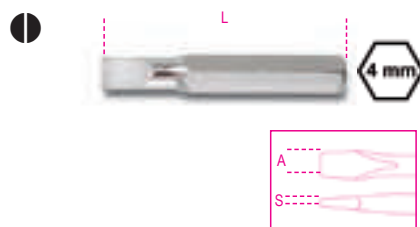

SxA	L	5	012560001
0,25x0,8	27		
0,25x1,2	27		
0,3x1,5	27		
0,35x1,8	27		
0,4x2,0	27		
0,4x2,5	27		
0,5x3,0	27		
0,6x3,5	27		
0,8x4,0	27		

1256PH

4-mm bits for cross head Phillips® screws



PH	L	5	012560011
000	27		
00	27		
0	27		
1	27		

1256PZ

4-mm bits for slotted head Pozidriv® - Supradriv® screws



PZ	L	5	012560061
000	27		
00	27		
0	27		
1	27		

1256PE

4-mm bits for hexagon head screws



mm	L	5	012560021
0,7	27		
0,9	27		
1,3	27		
1,5	27		
2,0	27		

1256TX

4-mm bits for Torx® head screws



T	L	5	012560041
T3	27		
T4	27		
T5	27		
T6	27		
T7	27		
T8	27		
T9	27		
T10	27		
T15	27		

1256RTX

4-mm bits for Tamper Resistant Torx® head screws



T	L	5	012560051
T6	27		
T7	27		
T8	27		
T9	27		
T10	27		

1256/20

hexagon drive extension, 4 mm



1256/20	5	012560092

1256/30

4-mm bit holder with handle



L	2	012560097
110		

1257LP

micro-screwdrivers for slotted head screws



SxD	L	5	012570012
0,25x1,2	60		
0,23x1,5	60		
0,3x1,8	60		
0,4x2	60		
0,4x2,5	60		
0,5x3	60		
0,6x3,5	60		
0,8x4	60		



1257LP/S8
0,2x1,2-0,25x1,5
0,3x1,8-0,4x2-0,4x2,5
0,5x3-0,6x3,5-0,8x4 mm

1 012570200

1257PH

micro-screwdrivers
for cross-head Phillips® screws



PH	L mm	
00	60	5 012570060
0	60	5 012570063
1	60	5 012570066

1257LPH/S8



1257LPH/S8
1257PH PH00-PH0-PH1
1257LP 0,4x2-0,4x2,5-0,5x3
0,6x3,5-0,8x4 mm

1 012570210

1257ES

micro-screwdrivers hexagon male ends



mm	L mm	
0,9	60	5 012570045
1,3	60	5 012570046
1,5	60	5 012570047
2	60	5 012570048
2,5	60	5 012570049
3	60	5 012570050

1257ESB/S8



1257ESB/S8
1257ES 0,9-1,3-1,5-2-2,5-3 mm
1257BE 4-5 mm

1 012570230

1257TX

micro-screwdrivers for Torx®
head screws



	L mm	
T5	60	5 012570075
T6	60	5 012570076
T7	60	5 012570077
T8	60	5 012570078
T9	60	5 012570079
T10	60	5 012570080
T15	60	5 012570081
T20	60	5 012570082



1257TX/S8
T5-T6-T7-T8
T9-T10-T15-T20

1 012570220

1257BE

micro-screwdrivers hexagon socket wrenches



mm	L mm	
3,2	60	5 012570085
4	60	5 012570086
5	60	5 012570087
5,5	60	5 012570088

1260

screwdrivers for slotted head screws

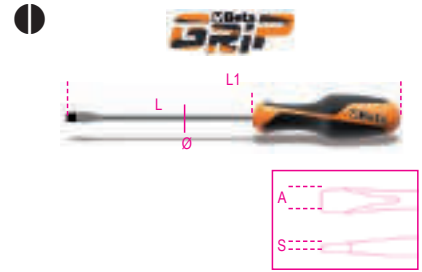

ISO 2380

SxAxL mm	L1 mm	Ø mm	
0,4x2,5x50	150	2,5	5 012600003
0,4x2,5x75	175	2,5	5 012600006
0,5x3x75	175	3,0	5 012600009
0,5x3x100	200	3,0	5 012600012
0,6x3,5x75	175	3,5	5 012600018
0,6x3,5x100	200	3,5	5 012600021
0,8x4x100	208	4,0	5 012600030
0,8x4x125	233	4,0	5 012600033
0,8x4x150	258	4,0	5 012600036
1x5,5x100	208	5,0	5 012600039
1x5,5x125	233	5,0	5 012600040
1x5,5x150	258	5,0	5 012600042
1,2x6,5x100	219	6,0	5 012600048
1,2x6,5x125	244	6,0	5 012600050
1,2x6,5x150	269	6,0	5 012600051
1,2x8x150	277	8,0	3 012600057
1,2x8x200	327	8,0	3 012600060
1,6x10x200	327	9,5	3 012600066
2x12x250	377	10	3 012600069
2x14x250	377	10	2 012600073



1260/S6
0,4x2,5x75-0,5x3x75-0,8x4x125
1x5,5x150-1,2x6,5x150-1,2x8x200 mm

1 012600306

1260N

screwdrivers for slotted head screws,
extra-short series



ISO 2380

SxAxL mm	L1 mm	Ø mm	
0,8x4x30	87	4	5 012600103
1,2x6,5x30	87	6	5 012600106



1260E

screwdrivers for slotted head screws with hexagon bolsters



ISO 2380

SxAxL mm	L1 mm	Ø mm		
1,2x6,5x150	269	6,0	3	012600156
1,2x8x175	301	8,0	3	012600157
1,6x10x200	327	9,5	2	012600159
2x12x250	377	9,5	2	012600162

1262

screwdrivers for cross head Phillips® screws



UNI/ISO 8764

PHxDxL mm	L1 mm		
0x3x60	160	5	012620003
0x3x100	200	5	012620006
1x4,5x80	188	5	012620009
1x4,5x120	228	5	012620012
2x6x100	219	5	012620018
2x6x150	269	5	012620021
3x8x150	277	3	012620024
4x10x200	327	3	012620027



1262/S4	
PH0x3x60-PH1x4,5x80 PH2x6x100-PH3x8x150 mm	1 012620304

1262N

screwdrivers for cross head Phillips® screws, extra-short series



UNI/ISO 8764

PHxDxL mm	L1 mm		
1x4,5x30	87	5	012620103
2x6x30	87	5	012620106

1262E

screwdrivers for cross head Phillips® screws with hexagon bolsters



UNI/ISO 8764

PHxDxL mm	L1 mm		
2x6x150	269	3	012620153
3x8x175	302	3	012620156
4x10x200	327	2	012620159

1262L

screwdrivers for cross head Phillips® screws, long series



UNI/ISO 8764-1

PHxDxL mm	L1 mm		
0x3x300	400	3	012620203
1x4,5x300	400	3	012620205
1x4,5x400	508	3	012620206
2x6x400	519	3	012620209

1263/D...

set of screwdrivers



1263/D6	
1260	0,5x3x75-0,8x4x100 1x5,5x125-1,2x6,5x150 mm
1262	PH1x4,5x80-PH2x6x100 mm

1263/D7	
1262	PH0x3x60 PH1x4,5x80 PH2x6x100 mm
1264	0,5x2,5x60-0,6x3x100 0,8x4x125-1x5x125 mm

1263/D7PZ	
1260	0,5x3x75-0,8x4x100 1x5,5x150-1,2x6,5x150 mm
1269PZ	PZ0 - PZ1 - PZ2

1263/D8	
1260	0,4x2,5x50-0,5x3x75 0,8x4x100-1x5,5x125 1,2x6,5x150 mm
1262	PH0x3x60-PH1x4,5x80 PH2x6x100 mm

1263/D10	
1260	0,5x3x75-0,6x3,5x100 0,8x4x125-1x5,5x150 1,2x6,5x150 mm
1260N	0,8x4x30
1262	PH0x3x60-PH1x4,5x80 PH2x6x100 mm
1262N	PH1x4,5x30

1263/S12

set of 12 screwdrivers



1263/S12	
1260	0,4x2,5x50-0,5x3x75 0,6x3,5x100-0,8x4x125 1x5,5x125-1,2x6,5x150 1,2x8x200-1,6x10x200 mm
1262	PH0x3x60-PH1x4,5x80 PH2x6x100-PH3x8x150 mm

1264

screwdrivers for headless slotted screws



SxDxL mm	L1 mm		
0,5x2,5x60	160	5	012640003
0,6x3x75	175	5	012640006
0,6x3x100	200	5	012640009
0,8x4x100	208	5	012640012
0,8x4x125	233	5	012640015
1x5x125	233	5	012640018
1x5x150	258	5	012640021
1,2x6,5x150	269	5	012640024



1264/S5	
0,5x2,5x60-0,6x3x75 0,8x4x100-1x5x125-1,2x6,5x150 mm	1 012640305

1264L

screwdrivers for headless slotted screws, long series



SxDxL mm	L1 mm		
0,5x2,5x200	300	3	012640203
0,6x3x300	400	3	012640206
0,8x4x400	508	3	012640209
1x5x400	508	3	012640215
1,2x6,5x400	519	3	012640218

1265ES

hexagon drivers with handles



mm	L mm	L1 mm		
1,5	100	200	3	012650015
2	100	200	3	012650020
2,5	100	200	3	012650025
3	100	200	3	012650030
4	100	208	3	012650040
5	100	219	3	012650050
6	125	244	3	012650060
8	150	277	2	012650080



1265ES/S8 1 012650308
1,5-2-2,5-3-4-5-6-8 mm

1266BP

ball head hexagon drivers with handles



mm	L mm	L1 mm		
2	100	200	3	012660020
2,5	100	200	3	012660025
3	125	225	3	012660030
4	125	233	3	012660040
5	120	239	3	012660050
6	140	259	3	012660060
8	160	287	2	012660080
10	160	287	2	012660100



1266BP/S8 1 012660308
2-2,5-3-4-5-6-8-10 mm

1267TX

drivers for Torx® head screws, with handles



	L mm	L1 mm	Ø mm		
T5	50	150	3	5	012670005
T6	50	150	3	5	012670006
T7	50	150	3	5	012670007
T8	60	160	3	5	012670008
T9	60	167	4	5	012670009
T10	80	188	4	5	012670010
T15	80	188	4	5	012670015
T20	100	208	4,5	5	012670020
T25	100	208	5	5	012670025
T27	115	234	6	5	012670027
T30	115	234	6	5	012670030
T40	130	257	7	2	012670040
T45	130	257	8	2	012670045



1267TX/D7 1 012670307
T6-T8-T10-T15
T20-T25-T30



1267TX/S13 1 012670312
T5-T6-T7-T8-T9
T10-T15-T20-T25
T27-T30-T40-T45

1268RTX

screwdrivers for Tamper Resistant Torx® head screws, with handles



	L mm	L1 mm	Ø mm		
T9	60	167	4,0	3	012680009
T10	80	188	4,0	3	012680010
T15	80	188	4,0	3	012680015
T20	100	208	4,5	3	012680020
T25	100	208	5,0	3	012680025
T27	115	234	6,0	3	012680027
T30	115	234	6,0	3	012680030
T40	130	257	7,0	2	012680040



1268RTX/S8 1 012680307
T9-T10-T15-T20
T25-T27-T30-T40

1269PZ

screwdrivers for cross head Pozidriv®-Supadriv® screws



UNI/ISO 8764

	L mm	L1 mm		
PZ 0	60	160	5	012690000
1	80	188	5	012690001
2	100	219	5	012690002
3	150	277	3	012690003
4	200	327	3	012690004



1269PZ/S4 1 012690304
PZ0-PZ1-PZ2-PZ3

1269N/PZ

screwdrivers for cross head Pozidriv®-Supadriv® screws, extra-short series



UNI/ISO 8764

PZ	L mm	L1 mm		
1	30	87	5	012690011
2	30	87	5	012690012

1281BG

interchangeable blade screwdriver handle



L mm	mm		
118	10	5	012810280

1281PM

quick-fit magnetic bit holder



L mm			
165		5	012810292

1281PB

socket holder with 1/4" male drive



L mm			
175		5	012810293

1281LP

reversible screwdrivers for slotted head screws



1281LP/1	0,8x4-1,2x6,5 mm	5	012810302
1281LP/2	1x5,5-1,2x6,5 mm	5	012810304

1281PH

reversible screwdrivers for cross head Phillips® screws



PH 1-2	5	012810310
2-3	5	012810312

1281LPH

reversible screwdrivers for slotted and Phillips® head screws



1281LPH/1	PH0-0,8x4 mm	5	012810321
1281LPH/2	PH1-1x5,5 mm	5	012810322
1281LPH/3	PH2-1,2x6,5 mm	5	012810323

1281PZ

reversible screwdrivers for cross head Pozidriv®-Supadriv® screws

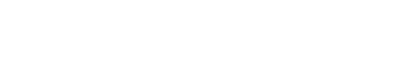

PZ 1-2	5	012810330
2-3	5	012810332

1281PE

reversible ball head hexagon screwdriver blades



mm 2,5	5	012810342
3	5	012810343
4	5	012810344
5	5	012810345
6	5	012810346

1281TX

reversible screwdrivers for Torx® head screws



1281TX/1	T6-T8	5	012810349
1281TX/2	T7-T9	5	012810350
1281TX/3	T10-T15	5	012810351
1281TX/4	T20-T25	5	012810352
1281TX/5	T30-T40	5	012810353

1281RTX

reversible screwdrivers for Tamper Resistant Torx® head screws



1281RTX/3	T10-T15	5	012810361
1281RTX/4	T20-T25	5	012810362
1281RTX/5	T30-T40	5	012810363

1281BG/A9

assortment of 9 reversible screwdrivers and 1 accessory in case



1281BG/A9	1	012810520
-----------	---	-----------

1281BG		
1281LPH/1	PH0-0,8x4 mm	
1281LPH/2	PH1-1x5,5 mm	
1281LPH/3	PH2-1,2x6,5 mm	
1281PZ/1	PZ1-PZ2	
1281PE	2,5 mm	
1281PE	3 mm	
1281PE	4 mm	
1281PE	5 mm	
1281PE	6 mm	

1281BG-TX/A8

assortment of 8 reversible screwdrivers and 1 accessory in case



1281BG-TX/A8	1	012810530
--------------	---	-----------

1281BG		
1281LPH/1	PH0-0,8x4 mm	
1281LPH/2	PH1-1x5,5 mm	
1281LPH/3	PH2-1,2x6,5 mm	
1281TX/1	T6-T8	
1281TX/2	T7-T9	
1281TX/3	T10-T15	
1281TX/4	T20-T25	
1281TX/5	T30-T40	

1281BG/B28A

set of 16 reversible screwdrivers,
9 1/4" drive sockets,
2 accessories and 1 handle, in wallet



1281BG/B28A

1 012810510

○ 900	4 - 4,5 - 5 - 5,5 6 - 7 - 8 - 9 - 10 mm
1281BG	
1281PB	■ 1/4
900/25	
● 1281LP/1	0,8x4 - 1,2x6,5 mm
● 1281LP/2	1,0x5,5 - 1,2x6,5 mm
⊕ 1281PH/1	PH1 - PH2
⊕ 1281PH/2	PH2 - PH3
⊕ 1281PZ/1	PZ1 - PZ2
⊕ 1281PZ/2	PZ2 - PZ3
○ 1281PE	2,5 - 3 - 4 - 5 - 6 mm
⊕ 1281TX/1	T6 - T8
⊕ 1281TX/2	T7 - T9
⊕ 1281RTX/3	T10 - T15
⊕ 1281RTX/4	T20 - T25
⊕ 1281RTX/5	T30 - T40

1281/BV

1 012810501

1290

screwdrivers for slotted head screws



ISO 2380

SxAxL mm	L1 mm	Ø mm	
0,4x2,5x50	146	2,5	5 012900003
0,4x2,5x75	171	2,5	5 012900006
0,5x3x75	171	3,0	10 012900009
0,5x3x100	196	3,0	10 012900012
0,6x3,5x75	171	3,5	10 012900018
0,6x3,5x100	196	3,5	10 012900021
0,8x4x100	196	4,0	10 012900030
0,8x4x125	221	4,0	10 012900033
0,8x4x150	246	4,0	10 012900036
1x5,5x100	209	5,0	10 012900039
1x5,5x150	259	5,0	10 012900042
1,2x6,5x100	220	6,0	10 012900048
1,2x6,5x150	270	6,0	10 012900051
1,2x8x150	282	7,0	3 012900057
1,2x8x200	332	7,0	3 012900060
1,6x10x200	332	8,0	3 012900066
2x12x250	382	10	2 012900069

Beta INOX

STAINLESS STEEL

258

1290/S

screwdriver set



1290/S5

1 012900305

1290 0,5x3x75-0,8x4x100 -1x5,5x150
1,2x6,5x150 -1,2x8x150 mm



1290/S9X

1 012900319

1290 0,4x2,5x75 - 0,5x3,5x100
0,8x4x125 - 1x5,5x150
1,2x6,5x150 - 1,2x8x200
1,6x10x200 mm
1290N 0,8x4x30 - 1,2x6,5x30 mm

1290N

screwdrivers for slotted head screws
extra short series



ISO 2380

SxAxL mm	L1 mm	Ø mm	
0,8x4x30	86	4	5 012900103
1,2x6,5x30	86	6	5 012900106

1292

screwdrivers for cross head
Phillips® screws



UNI/ISO 8764

PHxDxL mm	L1 mm	
0x3x60	156	10 012920003
0x3x100	196	5 012920006
1x4,5x80	189	10 012920009
1x4,5x120	229	10 012920012
2x6x100	220	10 012920018
2x6x150	270	10 012920021
3x8x150	282	3 012920024
4x10x200	332	3 012920027



1292/S4
PH0x3x60-PH1x4,5x80
PH2x6x100-PH3x8x150 mm

1 012920304

1292N

screwdrivers for cross head
Phillips® screws
extra short series



UNI/ISO 8764

PHxDxL mm	L1 mm	
1x4,5x30	86	5 012920103
2x6x30	86	5 012920106

1292L

screwdrivers for cross head
Phillips® screws, long series



UNI/ISO 8764-1

PHxDxL mm	L1 mm	
0x3x300	396	3 012920203
1x4,5x400	509	3 012920206
2x6x400	520	3 012920209

Beta INOX

STAINLESS STEEL

258

1293/D...

screwdriver set



1293/D6 1 012930401

1290 0,6x3,5x75-1x5,5x150
1,2x6,5x150 mm
1292 PH0x3x60 -PH1x4,5x80
PH2x6x100 mm

1293/D8 1 012930403

1290 0,5x3x75-0,8x4x100
1x5,5x150-1,2x6,5x150
1,2x8x150 mm
1292 PH0x3x60 -PH1x4,5x80
PH2x6x100 mm

1293/S...

screwdriver set

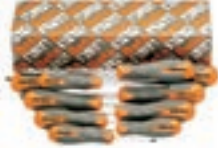

1293/S8 1 012930208

1290 2,5x50-3x75-4x100-5,5x150
6,5x150 mm
1292 PH0x3x60 -PH1x4,5x80
PH2x6x100 mm

1293/S10 1 012930201

1290 0,4x2,5x50 -0,6x3,5x100
1x5,5x100-1,2x6,5x150
1,2x8x150-1,6x10x200 mm
1292 PH0x3x60 -PH1x4,5x80
PH2x6x100-PH3x8x150 mm

1293/S12 1 012930203

1290 0,5x3x75-0,8x4x125
1x5,5x150-1,2x6,5x150
1,2x8x200 mm
1290N 0,8x4x30 mm
1292 PH0x3x60 -PH1x4,5x80
PH2x6x100-PH3x8x150 mm
1292N PH1x4,5x30-PH2x6x30 mm

1293/S7 1 012930207

1292 PH0x3x60 -PH1x4,5x80
PH2x6x100 mm
1294 0,5x2,5x60-0,6x3x75
0,8x4x100-1x5x125 mm

1293ES

hexagon drivers with handles



mm	L mm	L1 mm	Ø mm		
2	100	196	3	5	012930001
2,5	100	196	4	5	012930002
3	100	196	4	5	012930003
4	100	196	5	5	012930004
5	100	209	6	5	012930005
6	125	245	7	5	012930006
8	150	282	10	2	012930008



1293ES/S7 1 012930057
2-2,5-3-4-5-6-8 mm

1293BP

ball head hexagon drivers with handles



mm	L mm	L1 mm		
2	100	196	5	012930501
2,5	100	196	5	012930502
3	100	196	5	012930503
4	100	196	5	012930506
5	100	209	5	012930509
6	125	245	5	012930512
8	150	282	2	012930515



1293BP/S7 1 012930558
2-2,5-3-4-5-6-8 mm

1294

screwdrivers for headless slotted screws



SxDxL mm	L1 mm		
0,5x2,5x60	156	5	012940003
0,6x3x75	171	5	012940006
0,6x3x100	196	5	012940009
0,8x4x100	196	5	012940012
0,8x4x150	246	5	012940015
1x5x125	234	5	012940018
1,2x6,5x150	282	5	012940027



1294/S5 1 012940305
0,5x2,5x60-0,6x3x100
0,8x4x100-1x5x125
1,2x6,5x150 mm

1294L

screwdrivers for headless slotted screws long series



SxDxL mm	L1 mm		
0,6x3x300	396	3	012940206
0,8x4x400	496	3	012940209
1x5x400	509	3	012940215
1,2x6,5x400	532	3	012940218

1295

impact screwdriver



1295 1 012950001
L mm 130



1295/C14

impact screwdriver
with 14 insets and 1 socket holder



1295/C14 1 012950108

	866LP	1,2x6,5 - 1,6x10 mm
	866PH	PH2 - PH3
	866PZ	PZ2 - PZ3
	866PE	5 - 6 mm
	866TX	T27 - T30 - T40 - T45 - T50 - T55
	895/6	□ 1/2 - ○ 5/16
	1295	■ 1/2

170x100x35 mm - 1,3 kg

1297TX

drivers for Torx® head screws,
with handles



Drive	L mm	L1 mm	Ø mm	Quantity	Part No.
T6	50	146	3,0	5	012970006
T7	50	146	3,0	5	012970007
T8	60	156	3,0	5	012970008
T9	60	169	4,0	5	012970009
T10	80	189	4,0	5	012970010
T15	80	189	4,0	5	012970015
T20	100	209	4,5	5	012970020
T25	100	209	5,0	5	012970025
T27	115	235	6,0	5	012970027
T30	115	235	6,0	5	012970030
T40	130	262	7,0	2	012970040
T45	130	262	8,0	2	012970045



1297TX/S12 1 012970312
T6-T7-T8-T9-T10
T15-T20-T25-T27
T30-T40-T45



1297TX/D6 1 012970409
T10-T15-T20
T25-T27-T30

1297TX/L

drivers for Torx® head screws, long series



Drive	L mm	L1 mm	Ø mm	Quantity	Part No.
T15	210	319	4,0	2	012970115
T20	210	319	4,5	2	012970120
T25	210	319	5,0	2	012970125
T30	210	330	6,0	2	012970130
T45	210	342	8,0	2	012970145



1297TX/L-S5 1 012970325
TX/L15-TX/L20-TX/L25-
TX/L30-TX/L45

1298RTX

screwdrivers for Tamper Resistant Torx®
head screws, with handles



Drive	L mm	L1 mm	Ø mm	Quantity	Part No.
T9	60	169	4,0	5	012980009
T10	80	189	4,0	5	012980010
T15	80	189	4,0	5	012980015
T20	100	209	4,0	5	012980020
T25	100	209	4,5	5	012980025
T27	115	235	5,5	5	012980027
T30	115	235	6,0	5	012980030
T40	130	262	7,0	2	012980040



1298RTX/S8 1 012980308
T9-T10-T15-T20
T25-T27-T30-T40

1299PZ

screwdrivers for cross head
Pozidriv®-Supadriv® screws



UNI/ISO 8764

PZ	L mm	L1 mm	Quantity	Part No.
0	60	156	5	012990000
1	80	189	5	012990003
2	100	220	5	012990006
3	150	282	2	012990009
4	200	332	2	012990012



1299PZ/S6 1 012990306
1299PZ PZ0-PZ1-PZ2-PZ3
1299N/PZ PZ1-PZ2

1299N/PZ

screwdrivers for cross head
Pozidriv®-Supadriv® screws
extra short series



UNI/ISO 8764

PZ	L mm	L1 mm	Quantity	Part No.
1	30	86	5	012990021
2	30	86	5	012990024

1302

double end dolly, round,
convex pein head



1 013020001
770

1303
curved dolly



g 1350 1 013030001

1304
sole dolly



g 875 1 013040001

1305
toe dolly



g 1190 1 013050001

1305Z
milled toe dolly



g 1065 1 013050002

1306
heel dolly



g 1040 1 013060001

1307
regular dolly



g 1100 1 013070001

1308
egg dolly



g 1100 1 013080001

1309
hatchet dolly



g 460 1 013090001

1310
general purpose dolly



g 1225 1 013100001

1312
anvil dolly



g 1220 1 013120001

1313
buffer dolly



g 990 1 013130001

1314
double end dolly, convex, flat head



g 760 1 013140001

1326
curved angle spoon



g 560 1 013260001

1327
heavy-duty spoon



g 1075 1 013270001

1328
pry and bumping spoon

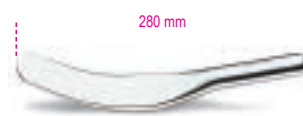

g 935 1 013280001

1329

double-ended spoon



435 mm

g 1800 1 013290001

1330

long double-ended spoon



510 mm

g 2125 1 013300001

1331

bending iron with leather face



410 mm

g 1100 1 013310001

1335BM

bumping blade with plastic handle



375 mm

g 500 2 013350010

1337/S5

set of 5 stopping knives for car repairers, made of stainless steel

Japanese type (25-50-75-100-125 mm)



L mm 25-50-75-100-125 1 013370015

1338A - 1338B

adjustable body blade holder with flexible flat blades



L

	mm/1"	L mm	
1338A	9	360	2 013380001
1338B	12	360	2 013380002

1338

body blade holder for item 1338R



1338 2 013380003

1338R9 - 1338R12

spare body blades for item 1338A-B



	mm/1"	
1338R9	9	2 013380004
1338R12	12	2 013380005

1342

extra flat chisel with straight cutter



L mm 235 5 013420001

1342PM

extra flat chisel with straight cutter with hand guard

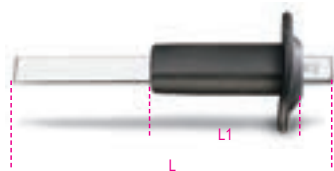

L mm 235 L1 mm 118 2 013420002

1342PMR

spare hand guard for item 1342



1342PMR 1 013420003

1343

flat chisel with side cutter



L mm 200 5 013430001

1344

feeler gauges for car body repair shops, pair, 10-bladed, with suction cup

suitable for:
• fitting rear windows
• maintaining position during installation



1344 1 013440010

1345

hammer with round, convex face and pein, wooden shaft



1345 2 013450010

1351

hammer with round, flat face and ball pein, wooden shaft



1351 2 013510010

1353

hammer with round, flat face and point pein, wooden shaft



1353 2 013530010

1357Z/45

hammers with flat, round, milled face and square, smooth face, wooden shafts



1357Z/45 2 013570045

1359T

hammer with round, flat face and horizontal pein, wooden shaft



1359 T 2 013590010

1360/K6

aluminium hammer with flat, round face, interchangeable plastic pins and punch

supplied with:
• 4 plastic pins
• 1 punch, adjustable in 2 different lengths, applicable to hammer



L mm 320
Ø mm 34
1 013600006

1360/KP3

hammers with ball heads and point peins/punches, made of plastic

Kit contents:
• 1 210 g hammer with head Ø 30 mm
• 1 290 g hammer with head Ø 40 mm
• 1 75 g punch with 5 mm pein



1360/KP3 1 013600503



1361/C12

set of Teflon® rods for body repair shops



1361/C12 1 013610012

275x160x57 mm

1362

dent reflector with suction cup

allows even the smallest bodywork imperfections to be detected



LxH mm 240 x200
1 013620010

1365/K13

oil pressure pump, 10 t, and bodywork accessories kit in trolley

Kit contents:
• oil pressure pump, 10 t, with 1.5-m-long hose, 1/2" coupling
• piston
• wing opening pliers; capacity: 500 kg
• baseplate, 150x90 mm
• L-shaped base, 50x50 mm
• 4-point punch
• round, knurled punch, Ø 50 mm
• wedge-shaped punch, 43 mm
• 240-mm-long extension
• 450-mm-long extension
• 475-mm-long extension
• rubber head
• male-to-male coupling for installing accessories



1365/K13 1 013650013

900x420x180 mm

1365P10

oil pressure pump
1.5-m-long hose, 1/2" coupling



1365P10 1 013650110

1366A

dent puller with kit of 19 plastic glue tabs

ideal for removing:
• hail dents
• dents caused by doors
• small dents in general



1366A 1 013660200

1366KF

kit of 19 plastic glue tabs for item 1366A



1366KF 1 013660205

1366/K5

pneumatic dent puller, with 1.1 kg hammer face

Kit contents:
• 1 suction cup Ø 75 mm
• 1 suction cup Ø 100 mm
• 1 suction cup Ø 125 mm
• 1 hook



1366/K5 1 013660010

610x240x90 mm

1366S

wheeled bodywork spotter

- microprocessor for managing welding parameters
- welding power and time adjustment
- adjustment range: 400÷2200 Ah
- single, pulsed, continuous point selector
- welding parameters table
- thermal protection indicator
- quick coupling gun
- voltage: 230 V

CE



1366S

1 013660000

1366S KIT

spotter accessory kit

- 10 slotted washers
- 10 90° slotted washers
- 100 threaded pins, 5x18 mm
- 100 self-threading pins, 5x18 mm
- 100 self-threading pins, 5x25 mm
- washer hook, Ø 8x16x1.5 mm
- electrode for M5-M6 screws
- electrode for slotted washers



1366S KIT

1 013660001

250x170x35

1366SL

pulling lever
for repairing dents on metal surfaces

articulated multihook head
for use with crimped wire



L
mm
700

1 013660002

1366ST

crossbar
for repairing dents on metal surfaces

articulated multihook head
for use with crimped wire



L
mm
850

1 013660003

1366S/R1

3-pointed washer mandrel



1366S/R1

1 013660501

1366S/R2

3-pointed washer
for pulling sheets



1366S/R2

1 013660502

1366S/R3

electrode for washers
Ø 8x16x1.5 mm



1366S/R3

1 013660503

1366S/R4

washer hook, Ø 8x16x1.5 mm



1366S/R4

1 013660504

1366S/R5

washers Ø 8x16x1.5mm



1366S/R5

1 013660505

1366S/R6

electrode for M5-M6 screws



1366S/R6

1 013660506

1366S/R7

100 self-threading pins, 5x18 mm



1366S/R7

1 013660507

1366S/R8

100 self-threading pins, 5x25 mm



1366S/R8

1 013660508

1366S/R9

100 threaded pins, M5 x 18 mm



1366S/R9

1 013660509

1366S/R10

10 slotted washers



1366S/R10

1 013660510

1366S/R11

electrode for slotted washers



1366S/R11

1 013660511

1366S/R12

10 90° slotted washers



1366S/R12

1 013660512

1366S/R13

sheet flattening electrode



1366S/R13

1 013660513

1366S/R14

wire spot welding electrode



1366S/R14

1 013660514

1366S/R21

crimped wires for use of pulling lever and crossbar



1366S/R21

1 013660551

1366S/R22

magnetic support for crimped wire



1366S/R22

1 013660552

1366S/R24

pull ring M4



1366S/R24

1 013660554

1366S/R25

pull ring M5



1366S/R25

1 013660555

1366S/R26

pull ring M6



1366S/R26

1 013660556

1367/S4

set of punches for installing parking sensors

sizes:
23 - 24 - 27 - 28



1367/S4

1 013670104

1367/S6

set of punches for installing parking sensors

sizes:
17 - 18 - 19 - 20 - 21 - 22 mm



1367/S6

1 013670100

1367

punches for installing parking sensors



Ø mm	○ mm	
17	13	1 013670117
18	13	1 013670118
19	13	1 013670119
20	13	1 013670120
21	13	1 013670121
22	13	1 013670122
23	13	1 013670123
24	13	1 013670124
27	13	1 013670127
28	13	1 013670128

1368

plastic repair kit

• Allows cracked and broken plastic parts to be quickly fixed

Power supply: 220÷240 V with Schuko socket
Heat gun cable length: 3.5 m
Power supply cable length: 1.35 m
2 power adjustments: 35-75 W
Heat gun with brass terminals, 2 staple insertion angles:
0°-90°
Input protection: thermal circuit breaker
Output protection: 10 A fuse
Metal gun pocket



1368

1 013680001

1368G/K400

assortment of 400 clips for item 1368



1368G/K400

1 013680140

1368G/OD

corrugated clips, straight, for item 1368



1368G/OD

1 013680100

1368G/SD

spiral clips, straight, for item 1368



1368G/SD

1 013680110

1368G/CV

convex angle clips for item 1368



1368G/CV

1 013680120

1368G/C2U

concave angle clips for item 1368



1368G/C2U 1 013680130

1369/C11

assortment of 11 tools



1369/C11 1 013690033

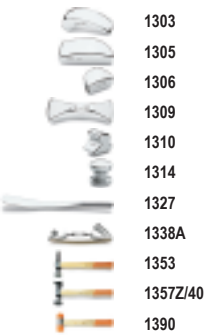

1303
1305
1306
1309
1310
1314
1327
1338A
1353
1357Z/40
1390

470x340x70 mm - 15.2 kg

1370

engineer's hammers, wooden shaft



UNI 7778 DIN 1041

HICKORY

g	A mm	L mm	L1 mm	
100	15	260	82	5 013700051
200	19	280	95	5 013700052
300	23	300	105	5 013700053
400	25	310	112	5 013700054
500	27	320	118	5 013700055
600	30	330	122	5 013700056
800	33	350	130	4 013700058
1000	36	360	135	4 013700060
1500	42	380	145	2 013700065
2000	47	400	155	1 013700070

1370/MR...

spare shafts for item 1370



1370MR 100	4	013700081
1370/100		
1370MR 200	4	013700082
1370/200		
1370MR 300	4	013700083
1370/300		
1370MR 400	4	013700084
1370/400		
1370MR 500	4	013700085
1370/500		
1370MR 600	4	013700086
1370/600		
1370MR 800	4	013700088
1370/800		
1370MR 1000	4	013700090
1370/1000		
1370MR 1500	4	013700095
1370/1500		
1370MR 2000	4	013700100
1370/2000		

1370T

mechanic's hammers
fibre shaft



g	A mm	L mm	L1 mm	
200	19	280	95	5 013700620
300	23	300	105	5 013700630
500	27	320	118	5 013700650
800	33	350	130	4 013700680
1000	36	360	135	4 013700700
1500	42	365	145	2 013700750

1370F

riveting hammers, wooden shaft



NF E 71.014

HICKORY

A mm	L mm	L1 mm	g	
24	260	77	280	2 013700424
26	260	80	310	2 013700426
28	280	86	400	2 013700428
30	280	92	450	2 013700430
32	300	100	550	2 013700432
36	300	104	720	2 013700436
40	330	110	1065	2 013700440
42	330	116	1080	2 013700442
50	380	138	1760	2 013700450
60	380	160	2585	2 013700460

1370F/MR...

spare shafts for item 1370F



1370F/MR 24	2	013700474
1370F/24-26		
1370F/MR 28	2	013700478
1370F/28-30		
1370F/MR 32	2	013700482
1370F/32-36		
1370F/MR 40	2	013700490
1370F/40-42		
1370F/MR 50	2	013700495
1370F/50		
1370F/MR 60	2	013700496
1370F/60		

1370FT

riveting hammers, fibre shafts



A mm	L mm	L1 mm	g	
28	280	86	530	1 013700528
30	280	92	625	1 013700530
32	300	100	750	1 013700532
36	300	104	930	1 013700536
40	330	110	1150	1 013700540
42	330	116	1250	1 013700542
50	380	138	2100	1 013700550
60	380	160	2750	1 013700560

1374F

carpenter's hammers, wooden shaft



NF E 71.012

HICKORY

A mm	L mm	L1 mm	g	
16	250	80	180	2 013740416
20	270	86	250	2 013740420
22	290	92	335	2 013740422
26	290	103	425	2 013740426
28	310	108	510	2 013740428
30	310	117	580	2 013740430

1374F/MR...

spare shafts for item 1374F



1374F/MR 16	2	013740456
1374F/16		
1374F/MR 20	2	013740460
1374F/20		
1374F/MR 22	2	013740462
1374F/22-26		
1374F/MR 28	2	013740468
1374F/28		
1374F/MR 30	2	013740470
1374F/30		

1375

claw hammer, wooden shaft



g	L1 mm	Ø mm	L mm	
300	95	25	300	3 013750000

1375/MR

spare shafts for item 1375



1375/MR	
	2 013750003

1375A

claw hammers, plastic shafts



oz	g	L mm	L1 mm	
16	450	330	130	3 013750016
20	570	330	130	3 013750020

1375B

claw hammers, steel shafts



oz	g	L mm	L1 mm	
16	450	330	130	3 013750026
20	570	330	130	3 013750030

1376X

claw hammers with square peins, magnets and nail holders
wooden shaft



g	A mm	L1 mm	L mm	
250	20	125	450	3 013760125
300	25	130	450	3 013760130
400	27	132	450	3 013760140

1376X/MR

spare shaft for item 1376X



1376X/MR	
	2 013760161

1376XT

claw hammers with square peins, magnets and nail holders
plastic shaft



g	A mm	L1 mm	L mm	
250	20	125	500	3 013760525
300	25	130	500	3 013760530
400	27	132	500	3 013760540

1376XT/MR

spare shaft for item 1376XT



1376MR/XT	
	2 013760585

1377

ball pein hammers, round heads, for coppersmiths and tinsmiths,
wooden shafts



HICKORY

g	L mm	L1 mm	
340	330	95	2 013770134
450	350	102	2 013770145
570	350	110	2 013770157
680	360	116	2 013770168
900	380	120	2 013770190

1377/MR...

spare shafts for item 1377



1377MR 340 1377/340	2 013770234
1377MR 450 1377/450	2 013770245
1377MR 570 1377/570	2 013770257
1377MR 680 1377/680	2 013770268
1377MR 900 1377/900	2 013770290

1377T

ball pein hammers, round heads, for coppersmiths and tinsmiths,
fibre shafts



g	L mm	L1 mm	
340	330	95	2 013770534
450	350	102	2 013770545
570	350	110	2 013770557
680	360	116	2 013770568
900	380	120	2 013770590

1378

joiner's hammers, round heads and peins, wooden shaft



HICKORY

g	L mm	L1 mm	Ø mm	
340	330	100	27	2 013780134
570	350	115	32	2 013780157

1378/MR...

spare shafts for item 1378



1378MR 340 1378/340	2 013780234
1378MR 570 1378/570	2 013780257

1379F

electrician's hammers, wooden shafts



NF E 71.011

HICKORY

A mm	L mm	L1 mm	
16	250	126	2 013790416
18	250	135	2 013790418
20	260	142	2 013790420

1379F/MR...

spare shafts for item 1379F



1379F/MR 16	2	013790426
1379F/16-18		
1379F/MR 20	2	013790430
1379F/20		

1380

lump hammers, wooden shafts



HICKORY

UNI 7777 DIN 6475

g	A mm	L mm	L1 mm		
800	38	260	90	2	013800208
1000	40	260	95	2	013800210
1250	43	260	100	2	013800212
1500	45	280	110	2	013800215
2000	50	300	120	2	013800220

1380/MR...

spare shafts for item 1380



1380MR 800	2	013800238
1380/800-1000-1250		
1380MR 1500	2	013800245
1380/1500		
1380MR 2000	2	013800250
1380/2000		

1380S

mason club hammers with security collars
wooden shafts



g	A mm	L mm	L1 mm		
800	36	260	90	2	013800400
1000	39	260	95	2	013800405
1250	43	260	100	2	013800410
1500	45	260	110	2	013800415

1380S/MR...

spare shafts for item 1380S



1380S/MR 800	2	013800417
1380S/800-1000-1250		
1380S/MR 1500	2	013800419
1380S/1500		

1380T

Mason club hammers,
fibre shafts



g	A mm	L mm	L1 mm		
800	35	260	85	2	013800308
1000	40	260	100	2	013800310
1250	42	260	110	2	013800312
1500	45	260	120	2	013800315

1381

sledge hammers, Hickory shafts



HICKORY

g	A mm	L mm	L1 mm		
3000	55	800	142	1	013810030
4000	60	900	152	1	013810040
5000	70	900	162	1	013810050
8000*	80	900	185	1	013810080

* = ash shaft

1381/MR...

spare shafts for item 1381



1381MR 3-4	2	013810730
1381/3000-4000		
1381MR 5	2	013810750
1381/5000		
1381MR 8	2	013810780
1381/8000		

1381T

sledge hammers,
fibre shafts



g	A mm	L mm	L1 mm		
3000	55	900	142	1	013810330
4000	60	900	152	1	013810340
5000	70	900	162	1	013810350

1385

copper head hammers, wooden shafts



g	A mm	L mm	L1 mm		
400	26	260	75	2	013850404
600	32	270	80	2	013850406
800	34	280	90	2	013850408
1000	37	280	100	2	013850410
1500	43	280	110	2	013850415
2000	48	300	120	1	013850420

1385/MR

spare shafts for item 1385



1385MR 400	2	013850464
1385 400		
1385MR 600	2	013850466
1385 600		
1385MR 800	2	013850468
1385 800		
1385MR 1000	2	013850470
1385 1000		
1385MR 1500	1	013850475
1385 1500		
1385MR 2000	1	013850480
1385 2000		

1390

soft face hammers, wooden shafts



UNI 7784

mm	L mm	L1 mm		
22	260	70	5	013900022
28	280	85	5	013900028
35	310	95	5	013900035
45	320	107	4	013900045
60	380	128	2	013900060

1390/MR...

spare shafts for item 1390



1390MR 22	2	013900222
1390/22		
1390MR 28	2	013900228
1390/28		
1390MR 35	2	013900235
1390/35		
1390MR 45	2	013900245
1390/45		
1390MR 60	2	013900260
1390/60		

1390R

spare faces for item 1390



∅ mm		
22	4	013900122
28	4	013900128
35	4	013900135
45	4	013900145
60	4	013900160

1390N

nylon face hammers, wooden shafts

Medium-hard faces: 75 Shore
Oil and wear resistant
Particularly suitable for working metal



UNI 7784

∅ mm	L mm	L1 mm		
22	260	70	3	013900522
28	280	85	3	013900528
35	310	95	3	013900535
45	320	107	2	013900545
60	380	128	2	013900560

1390NR

spare nylon faces for item 1390N



∅ mm		
22	4	013900622
28	4	013900628
35	4	013900635
45	4	013900645
60	4	013900660

1391

dead-blow hammers, entirely covered with rubber



∅ mm	L mm	L1 mm		
35	280	90	2	013910135
50	320	105	2	013910150
55	355	110	2	013910155
65	380	130	2	013910165

1391A

dead-blow hammers for tile workers, entirely covered with rubber



g	∅ mm	L mm	L1 mm		
500	45	290	100	2	013910205
1000	60	300	120	2	013910210

1392

dead-blow hammers, with interchangeable plastic faces, steel shafts



∅ mm	L mm	L1 mm		
30	300	105	2	013920030
35	305	115	2	013920035
40	310	125	2	013920040
50	325	135	2	013920050
60	385	155	2	013920060

1392R

spare faces for item 1392



∅ mm		
30	4	013920230
35	4	013920235
40	4	013920240
50	4	013920250
60	4	013920260

1393

hard rubber head hammers



∅ mm	L mm	L1 mm		
50	315	90	3	013930050
60	340	110	3	013930060
70	370	130	2	013930070

1410/M

spring pulling hook wrench



∅ mm		
3,5	2	014100051

1428

pullers for damaged nuts with square drive

3/8"

1/2"



∅ mm	□	L mm	○ mm		
8	3/8	36	17	2	014280008
10	3/8	36	17	2	014280010
11	3/8	36	17	2	014280011
12	3/8	36	19	2	014280012
13	3/8	36	19	2	014280013
14	3/8	36	19	2	014280014
15	1/2	38	21	2	014280015
16	1/2	38	21	2	014280016
17	1/2	38	21	2	014280017
18	1/2	38	26	2	014280018
19	1/2	38	26	2	014280019
20	1/2	38	26	2	014280020
21	1/2	38	26	2	014280021
22	1/2	38	26	2	014280022
24	1/2	38	26	2	014280024
27	1/2	38	26	2	014280027

1428L

socket pullers, long series, for damaged right-hand nuts, with square drive

1/2"



∅ mm		
17	1	014280217
19	1	014280219
21	1	014280221

1/2"



1428L/B3	1	014280303

3/8"

1/2"



1428/SB11	1	014280111
8-10-11-12-13-14		
15-16-17-18-19 mm		
1428/SB5	1	014280115
20-21-22-24-27 mm		

1429

pullers for damaged screws and stud bolts with square drive

3/8"

12"



mm	□	L mm		
2	3/8	60	3	014290002
3	3/8	60	3	014290003
4	3/8	60	3	014290004
5	3/8	60	2	014290005
6	3/8	60	2	014290006
8	1/2	70	2	014290008
10	1/2	70	2	014290010

3/8"

12"



1429/SB7
2-3-4-5-6-8-10 mm

1430/...

tapered extractors for broken screws and studs made from hardened and tempered steel

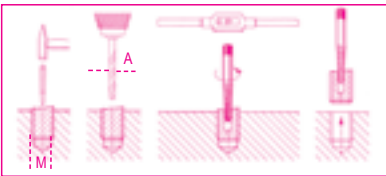

	M	A mm		
1430/1	3÷6	2,5	10	014300006
1430/2	6÷8	3,0	10	014300008
1430/3	8÷11	4,5	10	014300011
1430/4	11÷14	6,0	10	014300014
1430/5	14÷18	8,0	10	014300018
1430/6	18÷24	11,0	5	014300024
1430/7	24÷33	14,0	5	014300033
1430/8	33÷50	21,0	5	014300050



1430/S5	1	014300105
1430/1-1430/2-1430/3		
1430/4-1430/5		
1430/S6	1	014300106
1430/1-1430/2-1430/3		
1430/4-1430/5-1430/6		
1430/S8	1	014300108
1430/1-1430/2-1430/3		
1430/4-1430/5-1430/6		
1430/7-1430/8		

1431/C5

tapered extractors for broken screws and studs

Percussion mechanism



1431/C5	M mm	A mm		
	6÷18	3÷9	1	014310005

1433

roller stud extractors

3/8"

12"

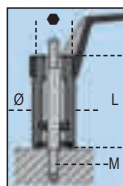

M mm	∅ mm	L mm	● mm	□		
5	21	60	19	3/8	2	014330005
6	24	60	21	1/2	2	014330006
7	24	60	21	1/2	2	014330007
8	24	60	21	1/2	2	014330008
9	28	70	21	1/2	2	014330009
10	28	70	21	1/2	2	014330010
10,5	28	70	21	1/2	2	014330021
11	28	70	21	1/2	2	014330011
12	28	70	21	1/2	2	014330012
14	36	72	24	-	2	014330014
16	36	72	24	-	2	014330016

1433/C11

roller stud extractors with 1/2" female square drives

3/8"

12"



1433/C11
M5 - M6 - M7 - M8 - M9 - M10 - M10,5
M11 - M12 - M14 - M16
340x135x56 mm - 3,0 kg

1435

eccentric stud extractor



∅ mm		
4÷20	1	014350001

1435R

spare wheel for item 1435



1435R 1 014350010

1435/1

eccentric stud extractor



∅
mm
19÷26 1 014350002

1435/1R

spare wheel for item 1435/1



1435/1R 1 014350011

1437/C12

assortment of 12 tools for removing air bags



1437/C12 1 014370001
260x160x55 mm - 1,0 kg

1438

universal clutch aligner complete with 3 expansion mandrels



1438 1 014380001

1438R

spare expansion mandrels
for item 1438



∅ mm	
14÷18	5 014380101
18÷21	5 014380102
22÷25	5 014380103

1438EVO

universal clutch aligning kit

Component parts made entirely from metal



1438EVO 1 014380011

290x200x60 mm - 2 kg

1438K/DSG

set of 13 tools for removing, installing and
adjusting VW 6- and 7- gear DSG clutches

Allows jobs on automatic and electronic dual clutch gearbox
transmissions.
Includes pliers for removing/installing snap ring of main shaft
and adjustment gauge for clutch system



1438K/DSG 1 014380250

1438DSG

lever for locking/unlocking DSG dual-clutch
gearbox
from VAG group



1438DSG 1 014380200

1438SAC

SAC clutch aligning kit

includes kit for applications without guide bearings
supplied with 3 and 4 arm plates



1438 SAC 1 014380050

480x380x130 mm - 9,5 kg

1439/K7

angular screwdriver (90°), long series,
with blades, in case

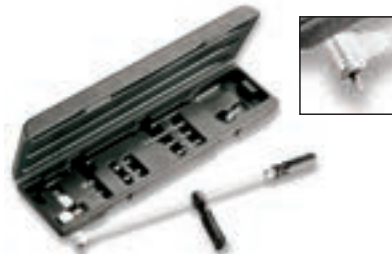

Case contents:
- Angular screwdriver
- 1 slotted screw head
- 1 1/4" bit head
- Special blade head
- 7 special blades

1439K7 1 014390101

500x120x60 mm 825 g

1440/...

piston ring compressors



	∅ mm	L mm	
1440/0	40÷75	50	1 014400000
1440/1	57÷125	80	1 014400010
1440/1A	57÷125	100	1 014400011
1440/2	90÷175	80	1 014400020
1440/2A	90÷175	100	1 014400021
1440/3	90÷175	165	1 014400030

1445/1 - 1445/2

piston ring expanders



	∅ mm	
1445/1	50÷100	1 014450001
1445/2	90÷150	1 014450002

1450GC

valve spring compressor
with straight and offset jaws



1450GC 1 014500005

1452K

valve spring compressor,
with three flanges

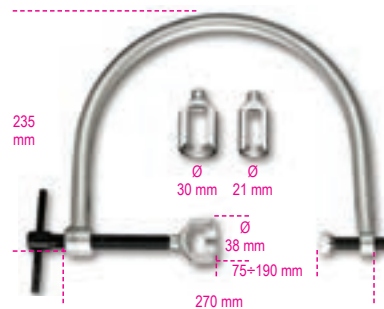

1452K 1 014520100

1452PN/K

pneumatic tool for engine valve springs

Thrust pressure: 1400 N



∅ mm	L mm	L1 mm	
16-19-23	230	185	1 014520110
25-30-42			

1455SVP

pneumatic valve grinder

• Pressure: 6 bars

CE



1455SVP 1 014550001

1455SVP/R...

spare parts for item 1455SVP



1455SVP/R1	5	014550501
1455SVP/R2	5	014550502
1455SVP/R3	5	014550503

1457/B4

tool set for releasing
Rilsan hose fittings

Sizes included in set:

- 6x8
- 10x12
- 15x16
- 18x1/2



1457/B4 1 014570024

1458

external butt-ended circlip pliers



DIN 5417

Ø mm	2	014580001
30÷100		

1460F

valve seat removing tool



1460F 1 014600010

1461/C3B

timing devices for
Fiat/Alfa/Lancia petrol engines

Engines: 1.2-1.4 16V



1461/C3B 1 014610032

280x245x75 mm 1,5 kg

1461/C5G

timing devices for Fiat/Alfa/Lancia/Opel/
Suzuki/Ford
diesel engines

Engines: 1.3 Multijet



1461/C5G 1 014610053

280x245x75 mm 2,6 kg

1461/C6B

timing devices for
Peugeot/Citroën petrol engines

Engines: 1.0-1.1-1.4-1.6-1.6 16v-1.6Gti-1.6 18V-1.8-1.8 16v-1.9-
2.0-2.0 16v-2.0T-2.0 Hpi-2.2 16v



1461/C6B 1 014610063

310x290x120 mm 3,5 kg

1461/C6G

timing devices for
Peugeot/Citroën diesel engines

Engines: 1.4-1.6-2.0D, 1.4-1.6TDci, 1.4-1.6-2.0-2.2Hdi,
1.5-1.9-2.5D



1461/C6G 1 014610064

385x290x100 mm 3,8 kg

1461/C7B

timing devices for
Renault/Nissan petrol engines

Engines: 1.4-1.6-1.8-2.0 16V



1461/C7B 1 014610072

280x245x75 mm 3,2 kg

1461/C8B

timing devices for Ford petrol engines

Engines: 1.25-1.4-1.6-1.6 SCTi-1.6 Ti-VCT-1.6 16V



1461/C8B 1 014610083

310x290x120 mm 1,8 kg

1461/C8G

timing devices for Ford/Mazda diesel engines

Engines: 1.4-1.6-1.8-2.0-2.2 TDCi, 1.6D 8/16V, 1.8D, 1.8D Turbo, 1.8 Tci, 1.8 TDDi, 2.5D, 2.5D Turbo



1461/C8G 1 014610084

280x245x75 mm 2,2 kg

1461/C9B

timing devices for Opel petrol engines

Engines: 1.0 12V, 1.0-1.2-1.4 16V



1461/C9B 1 014610092

335x145x60 mm 2 kg

1461/C10G

timing devices for Volkswagen/Audi/Seat and Skoda engines

Engines: 1.2-1.6-2.0 TDI CR (common rail)



1461/C10G 1 014610103

310x290x120 mm 2,8 kg

1461/C11A

timing devices for Renault engines

Engines: 2.0 dCi



1461/C11A 1 014610111

420x280x60 mm 1,2 kg

1461/C11G

timing devices for Renault engines

Engines: 1.5-1.9-2.2-2.5 DCI



1461/C11G 1 014610113

310x290x120 mm 3,8 kg

Beta

1461/C12A

timing devices for Fiat engines

Engines: 1.9-2.2 JTS and 1.9 JTD Euro 4



1461/C12A 1 014610123

280x245x75 mm 1,8 kg

1461/C12G

timing devices for Fiat/Alfa/Lancia diesel engines

Engines: 1.9 JTD, 1.6-1.9-2.0 Multijet



1461/C12G 1 014610124

280x245x75 mm 2 kg

1461/C13A

timing devices for Fiat 0.9 Twinair turbo engines



1461/C13A 1 014610133

240x210x50 mm 1,7 kg

Beta

1461/C13B

timing devices for Fiat 1.4 Multiair engines



1461/C13B  1 014610134

 240x210x50 mm  2,8 kg

1461/C17B

timing devices for Volkswagen/Audi/Seat and Skoda petrol engines

Engines: 1.2 TSI



1461/C17B  1 014610171

1461/C18B

timing devices for Volkswagen/Audi/Seat and Skoda petrol engines

Engines: 1.6-1.8-1.8T, 1.4-1.6-1.8-2.0 16V, 1.4-1.6-2.0 FSI



1461/C18B  1 014610182

 310x290x120 mm  2,5 kg

1461/C20G

timing devices for Fiat Iveco/Peugeot/Citroën/Ford diesel engines

Engines: 2.2-2.3-3.0 Multijet



1461/C20G  1 014610221

 385x290x100 mm  5,5 kg

1461/C21G

timing devices for Renault diesel engines

Engines: 1.6 dCi



1461/C21G  1 014610222

 310x290x120 mm  3 kg

1461/C22B

timing devices for Peugeot/Citroën petrol engines

Engines: 1.0-1.2 VTI



1461/C22B  1 014610223

 280x245x75 mm  2 kg



1461/C23B

timing devices for Opel petrol engines

Engines: 1.0 - 1.2 - 1.4 ecoflex



1461/C23B  1 014610224

 280x245x75 mm  2,5 kg



1461/C24B

timing devices for Mini-Peugeot/Citroën petrol engines

Engines: 1.4 - 1.6 (N12-N14)



1461/C24B  1 014610225

 280x245x75 mm  2,8 kg

1461/C25G

timing devices for Mini diesel engines

Engines: 1.6 diesel (W16D)



1461/C25G  1 014610226

 270x120x45 mm  1 kg



1461/C26B

timing devices for Fiat/Alfa Romeo/Lancia petrol engines

Engines: 1.2-1.4 8v



1461/C26B

1 014610227

280x245x75 mm - 1,7 kg

1461/C27G

timing devices for Bmw diesel engines

Engines: 1.6-2.0D (N47-N47S)



1461/C27G

1 014610228

280x245x75 mm - 2 kg

1461/C28B

timing devices for Volkswagen, Seat and Skoda petrol engines

engines: 1.0 - 1.0 Bluemotion Tech
1.0 Ecofuel/Ecomotive - 1.0 Green Tech



1461/C28B

1 014610229

280x245x75 mm - 1,7 kg

1461/C29B

timing devices for Ford petrol engines
engines: 1.0 EcoBoost



1461/C29B

1 014610209

280x245x75 mm - 2,6 kg

1461/C30G

timing devices for Volkswagen/Audi/Seat and Skoda diesel engines

engines: 1.6-2.0 CR TDI
for engines built as from 2012



1461/C30G

1 014610231

280x245x75 mm - 2 kg

1461/C31B

timing devices for Volkswagen/Audi/Seat and Skoda petrol engines

Engines: 1.0-1.2-1.4 TSI/TFSI



1461/C31B

1 014610232

270x230x80 mm - 2,1 kg

1461/C32G

timing devices for Opel diesel engines

Engines: 1.6 CDTi (B16)



1464/C32G

1 014610233

270x230x80 mm - 1,3 kg

1461/C33B

timing devices for Opel petrol engines

Engines: 1.0 - 1.0 Turbo SIDI Ecoflex



1461/C33B

1 014610234

1462CF/C6

set of 6 single-ended bi-hex wrenches for fuel injector connectors

sizes:
12-14-16-17-18-19 mm



1462CF/C6

1 014620006

260x145x60 mm - 1,2 kg

1462CF

single-ended bi-hex wrenches for fuel injector connectors



mm	
12	1 014620012
14	1 014620014
16	1 014620016
17	1 014620017
19	1 014620019
18	1 014620018

1462/KD

tool assortment for removing Denso injectors, complete with hammer





1462/KD  
1 014620060
335x210x80 mm - 4,8 kg

1462/KI

assortment of common rail diesel injector pullers

Allows DELPHI-BOSCH-SIEMENS-DENSO injectors to be removed





1462/KI  
1 014620235
530x470x140 mm - 20 kg

1462/KMRC

tool assortment for removing injectors from Mercedes 2.1L, 2.2L, 3.0 V6 and Chrysler engines

For Bosch (2.1 and 2.2L) and Delphi (3.0) injectors
Injectors can be removed without removing engine.
Particularly suitable for following car models:
Mercedes Vito, Vario, CLK, Sprinter, Viano,
M, GL, C, GLK, E, CLS, S, R, G Classes
Chrysler 300 C



1462/KMRC  
1 014620070
310x300x118 mm - 3,5 kg

1462/KU

universal tool assortment for removing diesel common rail injectors

Complete with pliers and hammer





1462/KU  
1 014620100
390x290x100 mm - 4,5 kg

1462AD/BSC

adapter for removing Bosch common rail injectors

For use with items Beta 960KI and Beta 1462/KU





1462AD/BSC  
1 014620435

1462AD/SMN

adapter kit for removing Siemens and Denso injectors

For use with item Beta 960KI/1462KI



1462AD/SMN  
1 014620436

1462/EI

universal vibration tool for injector removal

- Helps to fully remove jammed injectors from their housings, without damaging cylinder heads and without breaking injectors.
- Can be used with any injector removal set, with or without hammer face.
- Tool acts directly on removal tie rod, which is coupled with injector, through vibrations and pulses.
- Control valve allows vibration intensity to be adjusted to type of work to be carried out.





1462/EI  
1 014620240

1462PIM

injector maintenance plates, pair
vice locking
sections:
Ø 11-12-13-14-16-19-20 mm



1462PIM  
1 014620502

1463/KIT

valve timing system pulley locking kit



1463/KIT  
1 014630001
280x140x75 mm - 1,2 kg



1464T

digital pressure and compression tester

SPECIFICATIONS

- 5" touch screen display
- rechargeable polymer lithium battery
- complete with 80 bar sensor (for low pressure) and USB cable



1464T 1 014640050

960AD/TP2

set of adaptors for item 960TP
in plastic case



960AD/TP2 1 009600510

430x310x50 mm - 3,2 kg

1464IC

complete set of dummy injectors and dummy
glow plugs for item 1464T

Makes it possible to connect to the engine to check compression in
diesel engines with digital tester 1464T.

Contents:

- 22 dummy glow plugs
- 5 dummy injectors
- 1 universal dummy injector kit for cars, trucks, marine engines and agricultural machines



1464IC 1 014640350

559x312x50 mm - 4,5 kg

1464IC/RK

universal dummy injector kit for cars, trucks,
marine engines and agricultural machines
supplied with item 1464IC



1464IC/RK 1 014640377

200x110x30 mm - 885 g

1464AP

set for testing high pressure system in
common rail diesel engines,
with item 1464T

Complete with:

- high pressure pipe set
- fittings
- 2,000 bar sensor



1464AP 1 014640450

430x310x50 mm - 1,8 kg

1464AP T

high-pressure pipe
for items 1464AP and 960TAP



1464AP T12X12 1 014640453

1464AP T12X14 1 014640454

1464AP T14X12-M1,0 1 014640455

1464AP T16X12



1464AP T16X12 1 014640456

1464FG

set of dummy regulators
for testing diesel common rail system
(for use with Beta 1464T-1464AP)

Used with the tester and suitable adapters, it makes it possible to
determine whether the problem is the high pressure pump or the
regulator when there is no pressure in the high pressure circuit in
common rail engines.

Recommended for Bosch, Delphi, Denso and Siemens pressure
regulators



1464FG 1 014640470

350x250x80 mm - 1,8

1464FG/CP4

dummy regulator for Bosch CP4 pump,
not supplied with item 1464FG



1464FG/CP4 1 014640475

1464APB

set for testing high pressure
system in FSI petrol engines,
for use with item 1464T

comes with 200 bar sensor
and connectors



1464APB 1 014640500

240x210x50 mm - 0,5

 **Beta**

1464PB

set of 9 connectors for testing fuel low pressure (for use with item 1464T)

Quick connectors to tester 1464T allow fuel low pressure in diesel and petrol engines to be quickly checked



1464PB 1 014640700

530x440x120 mm - 3,8 kg

1464ADB

set for testing AdBlue® system pressure for item 1464T

Supplied with adaptors for use with 80-bar standard sensor supplied with item 1464T



1464ADB 1 014640620

240x210x50 mm - 0,5 kg

1464FAP

set for testing diesel particulate filter (DPF) pressure for item 1464T

Supplied with:
- 500 mbar sensor
- 8 mm adaptor with quick coupling and T fitting
- 3-m-long RJ45 cable



TECHNICAL DATA
Pressure test: 0+500 mbar
Resolution: 1 mbar

1464FAP 1 014640610

240x210x50 mm - 0,5 kg

1464PT

set for testing turbo pressure, for use with item 1464T

comes with sensor and connecting cable



1464PT 1 014640550

240x210x50 mm - 380 g

1464TDI

set for testing pump pressure in TDI engines, for use with item 1464T

comes with connector



1464TDI 1 014640600

240x210x50 mm - 400 g

1464VD

vacuum testing set for item 1464T

For measuring and storing maximum vacuum value
Supplied with:
- 800 mbar sensor
- 6 and 8 mm adaptors
- 3-m-long RJ45 cable

TECHNICAL DATA
Vacuum test: 0+800 mbar
Resolution: 1 mbar
Maximum value storage



1464VD 1 014640570

240x210x50 mm

1464PF

set for testing pressure in braking system, for use with item 1464T
comes with adaptors and connectors



1464PF 1 014640650

400x280x60 mm - 3 kg

1465

engine efficiency tester

Allows endothermic engine compression to be tested within just a few seconds, without requiring connection to engine, taking power from vehicle battery, through a dedicated software



CE



Step 1: calculating engine rpm
Step 2: testing battery voltage trend during each revolution
Step 3: displaying absorbed power and compression calculated through starter operation for each piston
Step 4: testing battery charge and efficiency

TECHNICAL DATA
Operating voltage: 12V DC (vehicle battery)
Dimensions: 140x75x30 mm
Clamp cable length: 1300 mm
Weight: 215 g

1465 1 014650010

1466/C5

kit of 5 brake
bleeding wrenches

kit contents:

- 5 wrenches sizes 7-8-9-10-11 mm
- 1 drain hose with check valve



1466/C5 1 014660100

260x170x50 mm - 600 g

1466L 11

brake bleeding wrench, 11 mm,
long version



1466L 11 11 60 1 014660211

1466TLF

brake oil recovery tank
capacity: 1.5 l

Quick coupler for bleeding pipe Ø 5.5 mm



1466TLF 1 014660201

1467

brake fluid extractor



Pressure: min 5 bar, max 11.5 bar

1467 1.5 1 014670001

1467/RK1

spare tube kit for item 1467



1467/RK1 1 014670501

1467/RK2

spare filler for item 1467



1467/RK2 1 014670502

1467LF

electric instrument for
brake fluid replacement

With "pulsating effect"



- Automatically stops when tank is empty, thereby preventing air from being let in
 - Maximum tank volume: 20 l
 - Operating pressure: 0.4+3.5 bar
 - Power supply: 230V
- Supplied with:
- Brake oil recovery tank
 - 1 universal cap + 1 standard cap E20

1467LF 1 014670100

1467LF/RC

vessel with recovery tube for item 1467LF



1467LF RC 1 014670125

1468N

valve depressors for disc removal

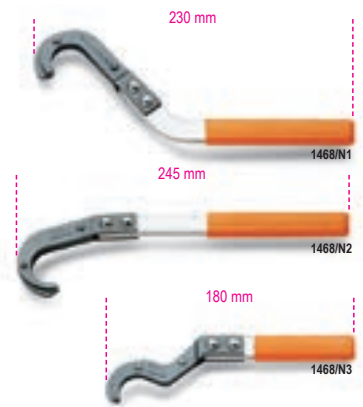

1468N/1 1 014680011
1468N/2 1 014680012
1468N/3 1 014680013

1470

drum brake spring pliers



L mm
210 1 014700001
330 1 014700002
540 1 014700010

1470FT

drum brake shoe spring clamp pliers

40° angled noses
Easy access to awkward spaces

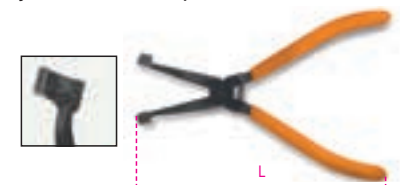

L mm
184 1 014700000

1471

drum brake spring pliers



L mm
330 1 014710001

1471A

handbrake wire pliers



A max mm 45 B mm 5 2 014710010

1471M/C22

pneumatic tool for pushing back and rotating right and left disc brake pistons with accessories



1471M/C22 1 014710101

350x310x85 mm - 3,5 kg

1471M/50

pneumatic tool for pushing back and rotating right and left disc brake pistons with accessories



50 mm 150 Kg 5÷8 Bar 1 014710069

1471M/P

worn pad and TRW-Mégane caliper adapters



1471M/P 1 014710080

1471M/W50

VW Passat handbrake adapter (≥ 2005)



1471M/W50 1 014710079

1471PN/B1

Ford handbrake adapter



1471PN/B1 1 014710081

1471PN/B2

Daily handbrake adapter



1471PN/B2 1 014710082

1471PN/B3

BMW handbrake adapter



1471PN/B3 1 014710083

1471PN/B4

BMW handbrake adapter

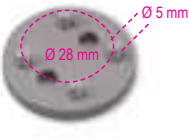

1471PN/B4 1 014710084

1471PN/B5

Mini/ BMW handbrake adapter

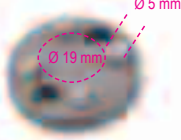

1471PN/B5 1 014710085

1471CF

pentagon hand sockets for brake caliper nuts



14 mm 19 mm 1 014710314 1 014710319

1471CM

pentagon socket driver for brake caliper screws



10 mm 1 014710360

1471CM/E11

hexagon socket driver, 11 mm, for Mercedes ML brake caliper screws (series 166)



11 mm 24 mm 75 mm 15,5 mm 1 014710361

1471D2

tool for pushing back front disc brake pistons, with closed callipers

Two pairs of plates for working on 2 and 4 piston callipers



10 mm 250x170x60 mm 1,5 kg 1 014710301

1472

hose clamp pliers



1472 1 014720001

1472AU

automatic hose clamp pliers



18-53 mm 1 014720100

1472R/AU

spare tips for pliers 1472AU



1472AU/R

1 014720101

1472AU/P

automatic hose ring pliers with extension



∅
mm
18+54

L
mm
630

1 014720105

1472AU/RP

spare cable for pliers 1472AU/P



1472AUP/R

1 014720106

1472FC

Clic® collar pliers with swivel heads



210 mm

1472FC

1 014720090

1472FC/GE

heavy-duty Clic® collar pliers

particularly suitable for large-size clippers



L
mm
230

1 014720093

1472FC/L

Clic® collar pliers with flexible extension



L
630 mm

1 014720095

1472FCL/RP

spare cable for pliers 1472FC/L



1472FCL/RP

1 014720096

1472FCA

collar removal pliers with Visa® type rack



140 mm

1472FCA

1 014720041

1472H

Henn clamp removal tool



L
1472H
100

1 014720000

1472MT/VW

pair of claws for disconnecting suction manifolds in VAG cars

Can be used on turbocharged petrol engines 1.0 - 1.2 - 1.4



1472MT/VW

1 014720500

1472TM

quick coupler pliers for multijet filters



230 mm

1472TM

1 014720200

1472VW

hose clamp pliers, with swivel heads
For Volkswagen and Mercedes cars



200 mm

1472VW

1 014720051

1473

OETIKER® collar pliers



275 mm

1473 275

1 014730001

1473A

slotholder pliers for OETIKER® collars



1473A 1 014730010

1473Q

OETIKER® collar pliers with drive

For use with:
• torque wrenches
• ratchets
• male drives



1473Q 1 014730005

1473P

clamp pliers for OETIKER® low-profile collars



1473P 53 1 014730020

1473FN

tool for tightening and cutting strap ties made of stainless steel

For use with Panduit® ties and the like



1473FN 4,7+9,5 1 014730501

1473T

steel collar cutting nippers

allows collars to be cut
without risking damaging guards, sleeves etc.



1473T 14 220 1 014730582

1474/C4

kit of 4 tools for removing Volkswagen spark plug coils



1474/C4 1 014740100

290x190x50 mm - 1 kg

1474E/VW

expansion puller for ignition coils,
Volkswagen group



1474E/VW 1 014740120

1474L

spark-plug pliers, curved long nose, 15°

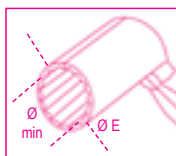

1474L 14 20 2 014740010

1474DL

spark-plug pliers, long nose,
double layer PVC coated handles



1474DL 170 mm 12 mm 275 mm 1 014740015

1474G

curved long nose pliers
for removing glow plug caps



1474G 1 014740200

1475U

combination pliers,
bright chrome-plated,
double layer PVC coated gun handles

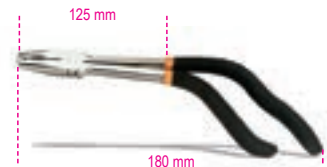

1475U 125 mm 180 mm 1 014750010

1476

adjustable self-locking pliers
for exhaust pipe cutting



1476 19 75 225 1 014760002

1476/RC

spare chain for item 1476



1476/RC 1 014760012

1476A

pliers for exhaust pipe cutting



Ø min mm	Ø max mm	1	014760005
30	95		

1476A/RC

spare chain for item 1476A



1476A/RC	1	014760015
----------	---	-----------

1476C/1

exhaust pipe expanders



1476C/1	1	014760101
Ø 30÷42 mm		
L = 131 mm		
L1 = 51 mm		

1476GT

pliers for removing rubber supports from exhaust pipes



L mm	A Max mm	± mm	1	014760050
280	58	3		

1476PSA

exhaust collar pliers with pin, PSA group
Nose shape and automatic rack locking make it possible to work without pulling out pin



L mm	A Max mm	S mm	1	014760060
309	60	12,2		

1476T

wrench for removing/installing turbines on Volkswagen Audi diesel engines



mm	1	014760200
12		

1477/C10

bent wrench with 9 bits for belt tightening nuts

1 bent wrench with bit drive
4 double bi-hex bits: 12x14 - 13x15 - 16x17 - 18x19 mm
5 bits for Torx(R) head screws: E10 - E12 - E14 - E16 - E18



1477/C10	1	014770310
530x110x55 mm		

1477D

ring wrenches for belt tightening nuts



mm	1	014770113
13		
15		014770115
16		014770116
17		014770117
19		014770119

1477D/S5

set of 5 ring wrenches for belt tightening nuts



1477D/S5	1	014770200
13-15-16-17-19 mm		
600x200x70 mm - 2,2 kg		

1477K/7

kit with bent reversible ratcheting wrench and bits



- 2 TORX T40-T45 bits
- 1 XZN 10 bit
- 1 hexagon bit, 8 mm
- 3 bi-hex bits, 10-12-13 mm

1477K/7	1	014770051
L mm		
250		

1478

pin removing pliers



1478	1	014780001
------	---	-----------

1478T

plastic pin removable pliers with swivel head and pressure clips

Head can be rotated 90°



1478T	1	014780101
S mm		
4,5		

1478/3P

plastic pin removal pliers with 3 release points



1478/3P	1	014780151
---------	---	-----------

1479

trim pin remover

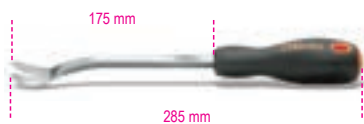

1479

2 014790001

1479/B27

kit of 27 nylon tools for removing pins and working on plastics and seals, hangable



1479/B27

1 014790407

1479L/S2

multipurpose wrecking bars, pair, made of Teflon®



1479L/S2

1 014790510

1479ML/S3

kit of 3 multipurpose wrecking bars, made of plastic
Particularly recommended for precision jobs



1479ML/S3

1 014790603

1479N/S5

kit of 5 nylon trim pin removers



1479N/S5

1 014790251

1479RB/1

straight putty knife scraper



1479RB/1

1 014790315

1479RB/2

bent putty knife scraper



1479RB/2

1 014790320

1479RB/3

flat putty knife scraper



1479RB/3

1 014790310

1479U/13

putty knife scrapers



1479U/13

2 014790010

1479U/32

trim pin remover, stainless steel blade



1479U/32

2 014790015

1480

Kit for filling diesel oil filters of cars without electric pumps

• Also for use with tyre inflators

Kit contents:

- GM quick couplings
- Renault, GM, Fiat quick couplings, inside Ø 6 mm
- Renault, GM, Fiat quick couplings, inside Ø 7 mm
- Ford quick couplings
- PSA quick couplings, inside Ø 6 mm
- PSA quick couplings, inside Ø 7 mm
- Ford quick couplings
- 2 cone-shaped adapters for cars without quick couplings



1480

1 014800010

410x320x70 mm

1481/C12

Kit of 6 pairs of hose pliers

Kit contents:

- 2 different pairs of pliers size 1/4"
- 2 different pairs of pliers size 3/8"
- 2 different pairs of pliers size 5/16"
- 3 pairs of rubber caps



1481/C12

1 014810312

370x270x59 mm

1481PL/A

plastic hose pliers

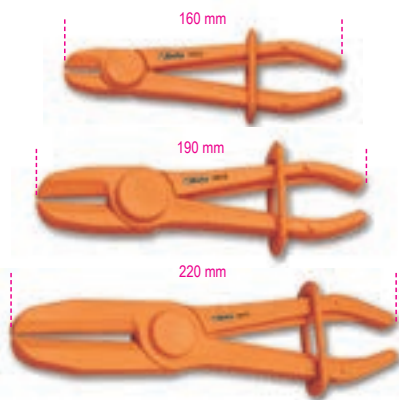

	∅ mm		
1481PL/A	8÷15	3	014810110
1481PL/B	15÷25	3	014810120
1481PL/C	25÷45	3	014810130

1481PL/S3

set of 3 plastic hose pliers



1481PL/S3		1	014810200
1481PL-A	∅ 8÷15 mm		
1481PL-B	∅ 15÷25 mm		
1481PL-C	∅ 25÷45 mm		

1482

adjustable self-locking wrench
for tank floating ring nuts



∅ mm		
89÷170	1	014820001

1482A/1

3-leg wrench for floating ring nuts,
tank with aluminium ring nut

For operating on aluminium ring nut installed on
Fiat, Volkswagen, Opel, Chevrolet, Mercedes and BMW cars
since 2011



∅ mm		
185	1	014820005

1482A/2

wrench for tank floating ring nuts,
12 sectors

For operating on ring nut with no side slots installed on
Fiat and Ford cars and vans



∅ mm		
132	1	014820006

1482A/3

wrench for tank floating ring nuts,
PSA group

So designed as to make it possible to operate on
decentralized axis
by removing ring nut, without damaging delicate fuel line



∅ mm		
157	1	014820007

1482A/4

wrench for tank floating ring nuts,
5 teeth

for use on FCA group cars,
including Freemont, 500L, 500X, Renegade



∅ mm		
145	1	014820014

1482A/5

wrench for tank floating ring nuts,
22 sectors

for use on plastic ring nuts
in VAG group cars



∅ mm		
180	1	014820015

1482/8 - 1482/10

quick coupler pliers for fuel pipes

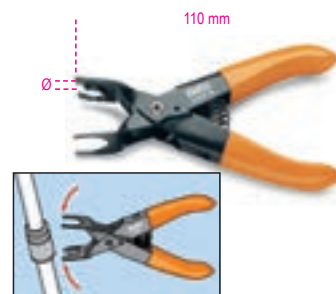

∅ mm		
1482/8	2	014820008
1482/10	2	014820010

1482B

quick coupler pliers
for fuel pipes



1482B	1	014820021

1482C

wedges (2 pairs) for releasing diesel fuel filter
fittings, Fiat, Volkswagen, Jeep, Chrysler
and Volvo groups

Quick filter replacement without
irreparably damaging fittings



1482C	1	014820022

1482D

quick coupler pliers for fuel pipes, with flexible extension



1482D

1 014820026

1483K/12

kit for removing valves from air-conditioning system with set of five-star head bits

Kit contents:

- 2 female octagon sockets, Ø 12 and 15 mm, for high-pressure valves
- 2 male open end sockets, section 2.2 and 3.2 mm, for throttle valves
- 1 set of five-star head bits: PT10, PT15, PT20, PT25, PT27, PT30, PT40



1483K/12

1 014830012

120x80x35 mm

1483KV-PT/S7

set of five-star head bits

Included sizes:

PT10 - PT15 - PT20 - PT25 - PT27 - PT30 - PT40



1483KV PT/S7

1 014830117

1483K/22

kit for separating couplers on air-conditioning, fuel supply and lubrication systems



1483K/22

1 014830022

300x230x55 mm - 1 kg

1484

set of 2 tools for removing and installing stretch belts

Allows stretch belt to be quickly removed and correctly installed, without risking damaging it



1484

1 014840010

1485BP

half-moon tool for locking toothed pulleys

can be adjusted through swivel handle, tightens and locks pulley from outside, preventing neighbouring sensors from getting damaged



A Max
mm
130

1 014850000

1485BPM

half-moon tool with aluminium jaws for locking multi-groove pulleys

can be adjusted through swivel handle; tightens and locks pulley from outside, preventing neighbouring sensors from getting damaged



A Max
mm
180

1 014850002

1485FCA/K2

tools for pre-loading timing belt bearings, pair, FCA group recommended for 1.2, 1.4 8/16 V and 1.4 Multiair engines

- 1 175-mm-long tool with 13.5-mm-deep push rods
- 1 305-mm-long articulated tool with 13.5-mm-deep push rods



1485FCA/K2

1 014850220

1485FCA/T

timing belt tensioner, long series, with 13.5 mm inserts



L mm
175
P mm
13,3

1 014850210

1485FCA/TS

timing belt tensioner, articulated, with 13.5 mm inserts



L mm
305
P mm
13,5

1 014850215

1485FRD/T

tensioning lever for service belts mounted on Ford engines

can be used to remove alternator pulleys



L mm
450
Q mm
12,80

1 014850310

1485/KIT

kit for controlling cam belt tension



1485/KIT

1 014850100

230x140x75 mm - 580 g

1485MJ

camshaft locking tool, for 1.3 16V Multijet engines

2 3-form heads for working on all 1.3 16V Multijet engines of FCA, Opel, Ford and Suzuki group vehicles



L mm
500

1 014850150

1485MTJ/1.3

distribution chain pulley locking tool for 1.3 Multijet engines

5 precise check pins allow totally safe jobs on chain



1485MTJ/1.3

1 014850160

1485PMTJ

driving shaft pulley release lever for Multijet engines

so designed as to lock driving shaft while removing pulley



L mm
450

1 014850190

1485R

universal tool for rotating camshaft pulleys made from forged steel with 2 pairs of tips



Ø mm 30÷120
Ø1 mm 10 - 17
L mm 500

1 014850025

1485R/P10

pairs of inserts



1485R/P10

1 014850035

1485R/P17

pairs of inserts



1485R/P17

1 014850038

1485TC

tensioning lever for service belts, mounted on Ford, PSA, FCA engines



L mm
475

1 014850330

1485VAG/K2

tools for pre-loading timing belt bearings, pair

- 3-position swivel head
- 1 tool with 12.5-mm-deep head
- 1 tool with 21.5-mm-deep head

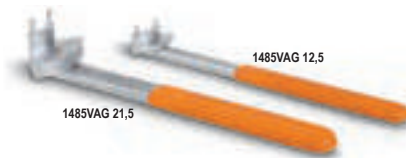

1485VAG/K2

1 014850080

1485VAG

tools for pre-loading timing belt bearings

- 3-position swivel head



	L mm	P mm
1485VAG/12,5	190	12,5
1485VAG/21,5	195	21,5

1 014850062
1 014850071

1486/10

wrench for natural gas cylinder valves

- VW group cars since 2008
- Panda from 2004 to 2012
- Grande Punto from 2005 to 2012
- Ducato since 2010
- new Doblò and Combo
- Cubo and Fiorino



36 mm

1486/10

1 014860110

1486/20

wrench for natural gas cylinder valves

- Multipla
- Ducato 1st and 2nd series until 2010
- Berlingo and Ranch
- C3 with iron cylinders
- Punto from 1999 to 2010
- Doblò 1st series
- Daily and Iveco group
- Dr5

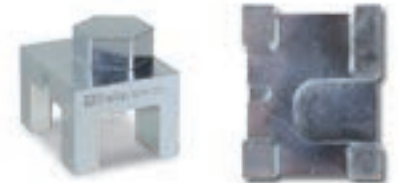

36 mm

1486/20

1 014860120

1486/30

wrench for natural gas cylinder valves

- Zafira 2nd series
- Combo 1st series

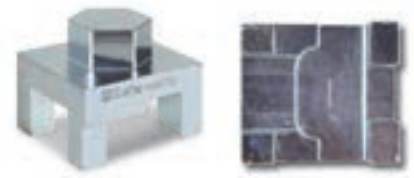

36 mm

1486/30

1 014860130

1486/40

wrench for natural gas cylinder valves

- Touran 1st series

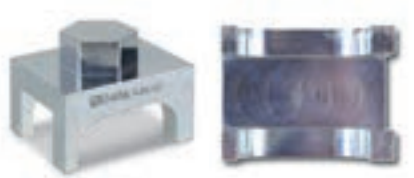

36 mm

1486/40

1 014860140

1486/50

wrench for natural gas cylinder valves

- Panda since 2012
- New Ypsilon



36 mm

1486/50

1 014860150

1486/60

wrench for natural gas cylinder valves

- C4 Picasso
- BRC systems



36 mm

1486/60 1 014860160

1486/70

wrenches for natural gas cylinder valves, pair

- C3 with composite cylinders

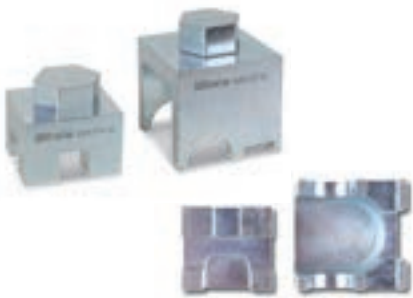

36 mm

1486/70 1 014860170

1486/80

wrench for natural gas cylinder valves

- B-Class
- Zafira 3rd series

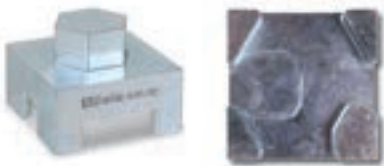

36 mm

1486/80 1 014860180

1486/90

wrench for natural gas cylinder valves

- Zafira 1st series
- Kangoo 1st series
- Sprinter



36 mm

1486/90 1 014860190

1488 - 1488L

oil-filter wrench with double chain



	∅ mm		
1488	60÷110	1	014880001
1488L	60÷160	1	014880050

1488/1

oil-filter wrench with thin double chain



	∅ mm		
1488/1	60÷110	1	014880010

1488R...

spare chain



1488RC	1488	1	014880101
1488R/L	1488/L	1	014880150
1488RC/1	1488/1	1	014880110

1489/31T

alternator pulley free wheel wrench



T50	15	31	1 014890016
-----	----	----	-------------

1489/33

alternator pulley free wheel wrench



1489/33	33	1	014890010
---------	----	---	-----------

1489/33P

alternator pulley free wheel wrench, for new Bosch FIAT Grande Punto alternators



	M	∅ mm		
1489/33P	10	15	31	1 014890015

1489/E

alternator pulley free wheel wrench

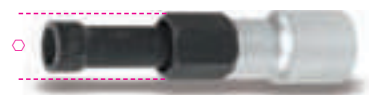

	∅ mm		
1489/E	10	15	1 014890025

1489R

alternator pulley free wheel wrench



1489/R	1	014890020
--------	---	-----------

1489/Y

alternator pulley free wheel wrench, for Nippondenso alternators



	∅ mm		
1489/Y	32	1	014890040

1489/C14

assortment of 14 tools for free alternator pulleys



1489/C14	1	014890100
----------	---	-----------

867PE	8 mm
867PE/L	8 mm
867XZ/N/L	M10
867TX/L	T50
867/2	1/2"
920B	10 mm
1489/33	
1489/33P	M10
1489R	
1489/Y	
1489/31T	T50
1489/E	10 mm
188	10 mm
188	15 mm

420x250x45 mm - 1,9 kg

1490

strap wrenches for oil filters

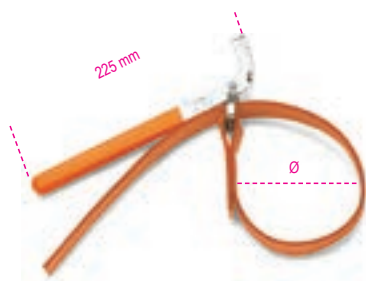

	Ø max mm		
1490/1	160	1	014900001
1490/2	240	1	014900002

1490/R1 - 1490/R2

spare fabric straps for item 1490



	Ø mm		
1490R/1	160	1	014900101
1490R/2	240	1	014900102

1490F

strap wrenches for filters

3/8"
1/2"



	Ø Max mm		
1490F	200	1	014900201

1491

adjustable oil filter wrench



	Ø mm		
1491	65÷110	2	014910001

1491R

spare metal band for item 1491



1491R		10	014910010

1491A

adjustable oil filter pliers

Precision adjustment through rack



L mm	Ø min - Max mm		
345	55 ÷ 140	1	014910040

1491T

adjustable truck oil filter pliers

Precision adjustment through rack
For use with drier filters

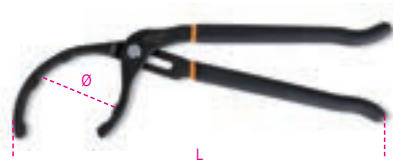

L mm	Ø min - Max mm		
500	70÷200	1	014910050

1492/1 - 1492/2

adjustable oil filter wrenches

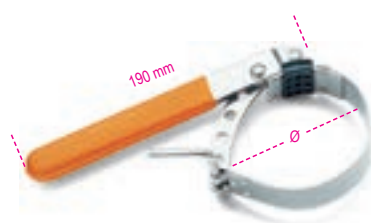

	Ø mm		
1492/1	60÷80	1	014920001
1492/2	80÷110	1	014920002

1492T

drier filter wrenches

1/2"



	Ø mm	H mm		
1492T 40	125÷145	40	1	014920540
1492T 75	120÷140	75	1	014920575

1493B

bi-hex wrenches
for hard-to-reach oil filter cartridges



mm	±0.1 mm		
24	8	1	014930524
27	8	1	014930527
32	8	1	014930532
36	8	1	014930536
38	8	1	014930538

1493B/S5

set of 5 bi-hex wrenches
for hard-to-reach oil filter cartridges

sizes:
24-27-32-36-38 mm



1493B/S5		1	014930599

1493

oil filter wrench

1/2"



Ø mm	N		
65	14	1	014930200
68	14	1	014930206
73	14	1	014930208
74	14	1	014930209
74	15	1	014930210
75-77	15	1	014930212
76	8	1	014930214
76	14	1	014930218
76-74	15	1	014930220
78	15	1	014930224
80	15	1	014930226
82-80	15	1	014930228
86	16	1	014930230
90	15	1	014930234
92	10	1	014930236
93	15	1	014930238
95	15	1	014930244
100	15	1	014930248
106	15	1	014930250
108	15	1	014930252
135	18	1	014930256

1493/PF

Purflux® oil-filter wrenches

12"



Ø mm	N		
66	6	1	014930202
76	12	1	014930216
76	30	1	014930222
86	18	1	014930232
93	36	1	014930240
93	45	1	014930242
96	9	1	014930070
96	18	1	014930246
108	18	1	014930254

1493/C30

set of 28 oil filter wrenches

12"



Sizes included in kit (Ø mm / n°. of sides)

1493:
 65/14 - 67/14 - 68/14 - 73/14 - 74/15
 76/15 - 75.77/15 - 76/14 - 76/8 - 78/15 - 80/15
 82/15 - 86/16 - 90/15 - 92/10 - 93/15 - 95/15
 100/15 - 106/15 - 108/15

1493PF (Purflux)

66/6 - 76/12 - 76/30 - 86/18
 93/36 - 93/45 - 96/18 - 108/18

- Includes 1 adjustable oil filter wrench
 Ø 65÷120 mm

1493/C30 1 014930000

530x400x110 mm - 4 kg

1493AL

oil filter wrenches

N= number of sides

38"

12"

38"



Ø mm	N		
64	14	27	1 014930310
66,5	14	27	1 014930315
74	14	27	1 014930320
79	15	27	1 014930325
84	14	27	1 014930330
87	16	27	1 014930335
92	15	27	1 014930340
94,5	15	27	1 014930345
100,5	15	27	1 014930350

1493AL 4S

oil filter wrenches
for Asian cars
4-hook profile

38"

38"

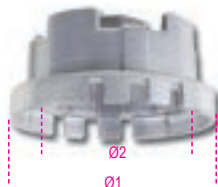

Ø1 mm	Ø2 mm		
70	64,5	27	1 014930304
80	64,5	27	1 014930305

1493AL CF

hexagon socket wrenches
for oil filter cartridges

12"

12"

12"



Ø mm	H mm		
24	34	27	1 014930424
27	34	27	1 014930427
30	34	27	1 014930430
32,5	34	27	1 014930432
36	34	27	1 014930436
38	34	27	1 014930438

1493/C19

set of 18 oil filter wrenches,
particularly suitable for Asian cars

Ø mm	N°. of sides
63-64	14
66.5	14
74	14
79	15
84	14
87	16
92	15
94.5	15
100.5	15

64.5 14 hook wrench for Toyota cars
 64.5 14 hook wrench for Lexus cars

6 hexagon sockets, sizes 24-27-30-32.5-36-38 mm, for filter cartridges

Kit includes 1 universal adjustable wrench Ø 58÷93 mm

12"

38"



1493/C19 1 014930019

490x450x60 mm - 4 kg

1493DSG

wrench for removing/installing
DSG oil filter

12"

12"



12" 1 014930800

1493FF

wrench for removing/installing plastic seats of
Ford Peugeot Citroën oil filters
engines: TDCi-HDi

Allows plastic seat to be correctly tightened
at 25 Nm by means of a torque wrench

12"

12"



12" 1 014930127

1493FT

wrench for Ford Transit Diesel oil filters

Can be used for all
Transit, Transit Custom and Tourneo Custom versions
manufactured since 2012

12"

12"



12" 1 014930085

1493J

wrench for MultiJet

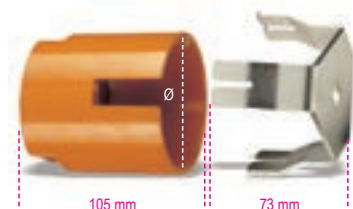

12" 1 014930080

1493VW

diesel oil filter wrench,
for VAG and Volvo cars

12"



∅
mm
82,5

1 014930086

1493/C7

self-adjusting oil filter wrench with three arms
for right- and left-hand tightening,
with interchangeable arms

antislip diamond finish

2 sets of arms:

- 1 set with 20 mm working length
- 1 set with 38 mm working length

38"



∅ mm ∅ mm
1493/C7 50÷100 16

1 014930079

210x150x50 mm

1493H

self-adjusting oil filter wrench with 3 arms,
for right and left hand tightening

Knurled jaws

38"

12"

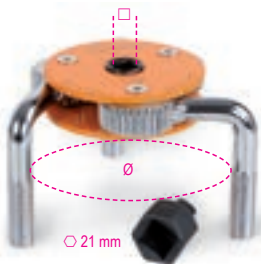

∅ mm
1493H 72÷127

1 014930077

1493/S-U

self-adjusting oil filter wrench with 3 arms,
for right and left hand tightening

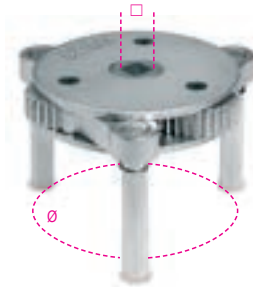

	∅ mm	
1493/S	3/8-1/2	80-115
1493/U	1/2	105-165

1493X

self-locking oil filter wrenches,
for left-hand tightening

38"



	∅ mm	± mm
1493X/1	60÷80	2,9
1493X/2	80÷98	2,9

1493Y

self-locking oil filter wrenches,
for right- and left-hand tightening,
heavy-duty version

item 1493Y/2 can also be used
for drier filters

12"



	∅ mm	± mm
1493Y/1	80÷110	7,3
1493Y/2	104÷145	7,3

1494

square oil drain plug socket

12"



mm
10 1 014940280

1494BMW

special socket for plastic oil drain plugs,
for BMW engines

38"



1494BMW 1 014940315

1494FPC

special socket for plastic oil drain plugs,
for Ford, Peugeot and Citroën engines

38"



1494FPC 1 014940320

1494E

male hexagon oil drain plug sockets

12"



mm	
8	1 014940208
9	1 014940209
10	1 014940210
11	1 014940211
12	1 014940212
14	1 014940214
17	1 014940217

1494Q

male square oil drain plug sockets

12"



mm	
8	1 014940258
9,5	1 014940259
12	1 014940262
13	1 014940263

1494T

male triangular oil drain plug socket

12"



mm
9,5 1 014940289

Beta

1494XZN

male oil drain plug socket with XZN® profile



M 16 1 014940296

1494VW

special socket for plastic oil drain plugs, Volkswagen engines

Allows plastic plug to be removed and installed from oil sump.
Specially designed for Volkswagen cars with TFSI and TDI engines



1494VW 1 014940305

1494VW/K

engine oil replacement kit, for VAG cars



Kit contents:
• 1 special socket for plastic oil drain plugs
• 6 plastic oil sump plugs

1494VW/K 1 014940310

1494/C14A

assortment of 14 oil change tools



1494/C14A 1 014940150

- 1494E 8-9-10-11-12-14-17
- 1494Q 8-9,5(3/8")-12-13
- 1494 10
- △ 1494T 9,5(3/8")
- 1494XZN M16

380x305x40 mm - 1,7 kg

1494M

tool for hexagon oil drain plugs, magnetic, flexible

Allows plug to be unscrewed without risking getting burnt or dirty

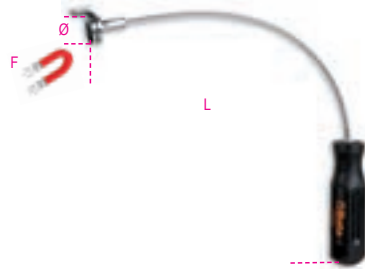

L mm 293 F kg 2,5 Ø mm 19 1 014940401

1495/C6

assortment of tools for repairing oil sump threads



- Damaged thread is removed by screw tap and enlarged by one size
 - Allows repairs and avoids replacing oil sump
- Contents:
- 1 screw tap M13x1.25 + 6 screws + 12 washers
 - 1 screw tap M13x1.5 + 6 screws + 12 washers
 - 1 screw tap M15x1.5 + 6 screws + 12 washers
 - 1 screw tap M17x1.5 + 6 screws + 12 washers
 - 1 screw tap M20x1.5 + 6 screws + 12 washers
 - 1 screw tap M22x1.5 + 6 screws + 12 washers

1495/C6 1 014950500

420x185x60 mm - 2,1 kg

1495M

screw tap for oil drain plug threads



M	
13x1,25	1 014950553
13x1,50	1 014950563
15x1,50	1 014950565
17x1,50	1 014950567
20x1,50	1 014950570
22x1,50	1 014950572

1495T

kit with 6 oil drain plugs and washers



M	
13x1,25	1 014950503
13x1,50	1 014950513
15x1,50	1 014950515
17x1,50	1 014950517
20x1,50	1 014950520
22x1,50	1 014950522

1496/C

oil plug wrench



8 x 10 mm 3 014960010

1497CEL

tool for removing electrical connectors from VAG group vehicles

allows connectors to be quickly disconnected, without getting damaged.



1497CEL 1 014970170

Beta

1497D

relay removal pliers, straight pattern



A
min+Max
mm
1497D 15+50 1 014970150

1497P

relay removal pliers, bent pattern, 60°



A
min+Max
mm
1497P 15+50 1 014970160

1497/C23

assortment of 23 tools for releasing electrical connectors



1497/C23 1 014970200
440x250x70 mm - 1,7 kg

1497/C94

assortment of 94 car testing connectors for use with main diagnostic tools

- 2 t-taps
- 2 potentiometers
- 2 warning lights
- 2 SRS connectors
- 2 alligator clips
- 2 acicular probes
- 2 prods
- 2 dual banana connectors
- 4 single banana connectors
- 24 flat male terminals 0.6+6 mm
- 12 round male terminals 1.6+3.9 mm
- 24 flat female terminals 0.6+6 mm
- 12 round female terminals 1.6+3.9 mm



1497/C94 1 014970300
430x390x100 mm - 3 kg

1497RC

t-taps, pair

- cable section: 1.5+3.5 mm
- voltage: 0+330V
- max. current: 5A



1497RC 1 014970351

1498

voltage tester

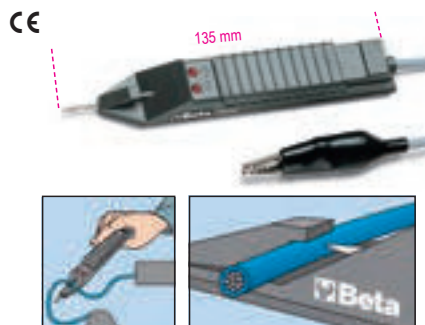

3+48V 2 014980100

1498CM/12

portable motorcycle emergency starter

3 functions in 1:

- starter
- additional battery for electronic devices (tablets, smartphones etc.)
- high-brightness LED torch



Equipment:

- Starting cable with insulated clamps and protection diode
- Mains battery charger
- Car battery charger
- USB cable with charge adapters

TECHNICAL DATA

Starting current: 200A
Peak current: 400A
USB outlet: 5V 2,1A
Dimensions: 130x50x15 mm
Weight: approximately 300 g

1498CM/12 1 014980030

1498MN/12

multipurpose portable starter

- Motor vehicle starting with 12-volt battery (diesel and petrol engines up to 2,000 cc)
- Charging of tablets, mobile phones and electronic devices in general
- Multi-use LED torch



STANDARD ACCESSORIES

- lithium-cobalt battery
- starting cables with insulated clamps and device protecting against polarity reversal and short circuits
- USB outlet for charging electronic devices
- digital display and battery charge indicator
- USB cable with charge adapters
- mains and car power supplier

TECHNICAL DATA

Pickup current: 600A
Battery type: LiCoO2
Starting output: 12 volts

1498MN/12 1 014980000

Beta

1498MN/12-C

booster cable with clamps for item 1498MN/12



1498MN/12-C

1 014980005

1498MN/12-R

mains power supplies for mini starter LT/12-R



1498MN/12-R

1 014980003

1498MN/12-P

car socket power supply for mini starters LT/12-P



1498MN/12-P

1 014980004

1498MN/12-U

USB cables with universal U adapters



1498MN/12-U

1 014980009

Beta

1498LT/12

portable high-performance starter, ultralightweight



CE

The microprocessor provides full protection against:

- polarity reversal
- short circuits
- incorrect voltage
- overloads
- underdischarge
- overcharge
- overtemperature

TECHNICAL DATA

Operating voltage: 12 V
 Continuous amperage: 800 A
 Maximum pickup amperage: 2000 A
 Peak amperage: 4000 A
 Cable length: 500 mm
 Battery type: 4-cell LifePo4
 Memory saving function: YES
 Dimensions: 260 x 135 x 72 mm
 Net weight: 2.5 kg
 Complete with charging power supply 12 V 1.3A

1498LT/12

1 014980012

1498LT/12-SF

wall fixing bracket for starter 1498LT/12



1498LT/12-SF

1 014980013

1498LT/12-R7

mains power supply for starter 1498LT/12



1498LT/12-R7

1 014980657

1498/12

Portable car starter, 12V



CE

TECHNICAL DATA:

- Pickup current: 2200A
- Shoulder strap included
- Sealed lead acid battery, solid electrolyte (AGM) type

1498/12

1 014980480

13 kg

1498/24

portable car and commercial vehicle starter, 12-24V



CE

TECHNICAL DATA:

- Pickup current: 4200A (12V) - 2100A (24V)
- Shoulder strap included
- Sealed lead acid battery, solid electrolyte (AGM) type

1498/24

1 014980490

17 kg

Beta

1498B12/R02

12V spare battery
for starters 12-24V



1498B12-R02

1 014980502

1498/12-24 R20

mains power supply for starters items 1498/12
and 1498/24



1498/12-24 R20

1 014980520

1498C/24

wheeled starter, 24V



CE

- Wheeled frame for easier movements and minimized effort
- Outstanding performance for numerous starts, including particularly demanding ones
- Electronic battery charger included
- LED and sound alarms in case of polarity reversal
- Protection against voltage peaks
- Battery charge indicator
- Solid electrolyte lead-acid battery (AGM)

Continuous amperage	1700 A
Operating voltage	24 V
Pickup amperage	4000 A
Cable length	2000 mm
Cable section	70 mm
Charging voltage	230 V
Automatic battery charger	24 V - 10 A

1498C/24

1 014980244

1498/2A

electronic motorcycle battery charger, 12V

allows charging of all
Pb Wet, Agm, Gel, MF and Vrla battery types
and LiFePo4 lithium batteries



CE

- Two different types of charge, for lithium and lead acid batteries respectively
- Automatic multi-stage charge cycle
- Reverse polarity and short-circuit protection
- IP65 degree of protection
- Complete with cable with clamps and cable with eyelets
- Power supply voltage: 220-240V

TECHNICAL DATA

- Charging current: 1A
- Charging capacity: 2Ah-40Ah
- Frequency: 50-60 Hz
- Battery voltage: 12V
- Dimensions: 180x80x40 mm
- Weight: 0.5 kg

1498/2A

1 014980102

1498/4A

Electronic car/motorcycle battery charger, 6-12
V



CE

- Protected against polarity reversal and short circuits
- Automatic 6 V or 12 V selection
- Automatic battery type selection
- Digital backlit display
- Pull-back fixing hook

TECHNICAL DATA

- Power supply voltage: 220V-240V
- Frequency: 50-60 Hz
- Rated current (min-max): 1-4 Amp
- Battery voltage: 6V/12V
- Battery capacity: 4Ah-80Ah
- Charging time: 12 hours
- Degree of protection: IP65

1498/4A

1 014980104

1498SA/2A-4A

cable with cigarette lighter plug
for items 1498/2A and 1498/4A



1498SA/2A-4A

1 014980120

1498/8A

Electronic car / commercial vehicle battery
charger, 12 V



CE

- Slow and quick charge (2A-8A)
- Flat battery recovery function
- Power supply function 13.8V-5A
- Protected against polarity reversal and short circuits
- Manual battery type selection
- Digital backlit display
- Pull-back fixing hook

TECHNICAL DATA

- Power supply voltage: 220V - 240V
- Frequency: 50-60 Hz
- Rated current (min-max): 2-8 Amp
- Battery voltage: 12V
- Battery capacity: 5Ah-160Ah
- Memory saving feature: 13.8V - 5A
- Degree of protection: IP65

1498/8A

1 014980108

1498/4A-8A CO

eyelet cable for items 1498/4A and 8A



1498/4A-8A-CO

1 014980114

1498/4A-8A CP

cable with clamps for items 1498/4A and 8A



1498/4A-8A-CP

1 014980118

Beta

1498/2A-8A-PR

extension for item 1498/2A/4A/8A



1498/2A-8A-PR

1 014980119

1498/16A

electronic multipurpose battery charger, 12-24V



- backlit graphic display
- max. charging current: 16A, continuous
- charging and charge maintenance
- protected against polarity reversal and short circuits
- 9 charging steps
- floating system
- SHOW ROOM function (13.8V - 12A)
- SUPPLY function (14V - 12A)
- memory saving function (13.8V - 12A)
- battery recovery function
- clamp holder
- reclining hook fastening
- supplied accessories: cable with clamp, cable with eyelets

TECHNICAL DATA

Power supply: 220-240V
 Power: 390W
 Charging current: 4-16A
 Battery types: Agm - Wet - Lithium (LiFePo4)
 Charging capacity: 5-360Ah
 Maintenance capacity: 5-550Ah
 Output voltage: 12-24V
 Minimum battery voltage: 0.8V
 Degree of protection: IP34

1498/16A

1 014980126

Beta

1498/30A

electronic multipurpose battery charger, 6-12-24V

Allows batteries to be charged and powers motor vehicles during diagnostic operations



- maximum continuous charging current: 30A
- charging and maintenance
- battery recovery
- reprogramming and power supply
- protected against polarity reversal, short circuits, incorrect voltage and overload

TECHNICAL DATA

Power supply: 220-240V
 Power: 500W
 Charging current: 5-30A
 Battery types: Agm - Wet - Lithium (LiFePo4)
 Charging capacity: 5-300Ah
 Maintenance capacity: 5-900Ah
 Output voltage: 6-12-24 Volt

1498/30A

1 014980130

1498/50A

electronic multipurpose battery charger, 12V

For charging and powering vehicles while reprogramming and self-diagnosing



SPECIFICATIONS

- Max. charging/power supply current: 50 Amp
- charging
- battery recovery
- power supply for ECU diagnostic protocols
- electronic management through microprocessor
- protected against polarity reversal and short circuits

TECHNICAL DATA

Cable length: 3m
 Section: 10 mm²
 Charging capacity: 5-500Ah
 Maintenance capacity: 5-1500Ah
 Voltage: 12V

1498/50A

1 014980050

150x100x250 mm

1498/120A

electronic multipurpose battery charger, 12V

Allows batteries to be charged and powers motor vehicles while reprogramming and self-diagnosing



- maximum continuous charging current: 120A
- charging and maintenance with CPU microprocessor
- battery recovery function
- reprogramming and power supply for ECU
- protected against polarity reversal, short circuits, incorrect voltage and overload

TECHNICAL DATA

Power supply: 90-260V
 Power: 1500W
 Charging current: 10-120A
 Battery type: Agm - Wet - Lithium (LifePo4)
 Charging capacity: 10-1200Ah
 Maintenance capacity: 5-3600Ah
 Output voltage: 12 Volt
 Cable length, with clamps: 2700 mm
 Dimensions: 310 x 150 x 350 mm
 Weight: 8.5 kg

1498/120A

1 014980142

1498/40A

multipurpose battery charger / starter, 12-24V wheeled

Since no internal battery is available, the start function (max. 350A) does not replace that of a specific starter type 1498LT/12 (2000A).



CE



- 3 programmed charging cycles and 1 manual cycle
- electronic adjusting potentiometer
- specific WET-SPIRAL/GEL-AGM charging cycles
- electronic control and protection system
- 10-stage charging process
- battery desulfurization and recovery function
- supply function
- dual voltage, 12-24V
- also suitable for Start&Stop batteries
- professional rubber-insulated brass clamps

TECHNICAL DATA

Power supply: 230V
Output voltage: 12-24V
Charging current: 1-40A
Starting current: 350A max cc
Charging capacity: 4-450Ah

1498/40A



1 014980140

330x250x792

1498SM

memory saver, 12 V

prevents data stored by computer on board cars from getting lost during maintenance jobs or battery replacement.



CE



Technical specifications:

- self-supplied
- internal battery Pb 5 Ah
- 12 volts
- professional connection with OBD socket

1498SM



1 014980020

1498SM-C

OBD II car memory saver connectors, 12V, for item 1498SM/C



1498SM-C



1 014980021

1498SM-CP

car memory saver connectors, 12V clamp, for item 1498SM/CP



1498SM-CP



1 014980022

1498SM-A

memory saver power supplies for item 1498SM/A



1498SM-A



1 014980023

1498TB/12-24

digital battery tester, 12V, and starting/charging system analyzer, 12-24V

- allows the following to be tested: battery, alternator (smart and normal) and starter, diode ripple and chassis test
- fitted with software for printing test from PC
- backlit display
- compact, shockproof frame
- 10 language software
- complete with input for connecting a removable mini printer (optional accessory, Beta 1498ST/TB)



TECHNICAL DATA:

- applications: 12V battery test - Alternator charge test, 12-24V - Starter test
- operating range: 100-2000 CCA
- reference standards: CCA, SAE, DIN, EN, IEC, JIS
- supported batteries: PB, WET, GEL, AGM, AGM FLAT, EFB
- voltmeter: 9V-36V
- cable length: 1600 mm
- languages: Italian, English, French, German, Spanish, Polish, Romanian, Dutch, Swedish and Finnish
- accessories included: USB cable and software

1498TB/12-24



1 014980401

1498ST/TB

mini thermal printer for tester item 1498TB/12

- Mini printer can be directly connected to tester
- Allows test results to be printed



CE

1498ST/TB



1 014980410

1498ST/TB ROT

paper refill for printer 1498ST/TB



1498ST/TB ROT



2 014980411

1498PC

voltage stabilizer, 12-24 V

Protects control units in welding and starting processes



1498PC



1 014980801

1498TC

digital glow plug tester

- Quick, accurate glow plug testing
- Suitable for all types of glow plugs, 4.4-5-7-8.5-10-11 Volts
- Digital backlit display
- Suitable for steel and ceramic glow plugs
- Short circuit and polarity reversal protection
- Turns off automatically when not in use
- With buzzer
- With SMD LED torch
- Compact, shockproof frame



CE

- Measurement range: 0.00÷25.0Ω
- Tolerance: ± 2%
- Resolution: 0.01
- Led Display: 1.8"
- Operating temperature: 0°C÷50°C
- Power supply: 1 9V battery (not included)

1498TC

1 014980450

1499

sonoscope probe



1499

1 014990001

1500/...

two-leg universal pullers

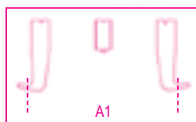

	L mm		
1500/1	100	1	015000301
1500/2	100	1	015000302
1500/3	150	1	015000303
1500/4	150	1	015000304
1500/5	205	1	015000305
1500/6	205	1	015000306
1500/7	205	1	015000307
1500/8	230	1	015000308

	A min+Max mm	A1 min+Max mm
1500/1	25÷80	70÷130
1500/2	25÷130	80÷180
1500/3	50÷160	105÷220
1500/4	60÷200	120÷270
1500/5	80÷250	160÷330
1500/6	80÷350	160÷420
1500/7	110÷520	195÷600
1500/8	170÷640	260÷715



1500/SP5	1	015000325
1500/1-1500/2-1500/3		
1500/4-1500/5		
1500/SPV	1	015000001

1500G/...

legs, pair, standard series,
for items 1500 and 1580/81



	mm	1500	
1500G/1	35	/1-2	1 015000311
1500G/3	35	/3-4	1 015000313
1500G/5	35	/5-6-7	1 015000315
1500G/8	50	/8	1 015000317
		1580/81	

1500N/...

universal pullers with 2 sliding legs

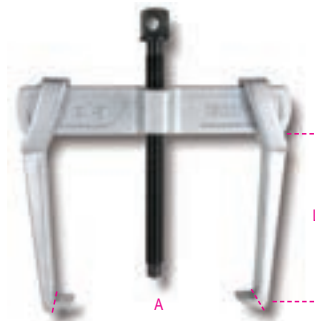

	A min+Max mm	L mm	
1500N/0	18÷65	70	1 015000600
1500N/1	23÷70	100	1 015000601
1500N/2	23÷100	100	1 015000602
1500N/3	35÷140	150	1 015000603
1500N/4	35÷190	150	1 015000604
1500N/5	43÷250	205	1 015000605
1500N/6	43÷320	205	1 015000606



1500N/SP6	1	015000626
1500N/0-1500N/1-1500N/2-1500N/3		
1500N/4-1500N/5		
1500N/SPV	1	015000006

1500N/G...

loose legs for pullers 1500N



	mm	1500N	
1500N/G0	10	/0	2 015000650
1500N/G1-2	12	/1-2	2 015000651
1500N/G3-4	17	/3-4	2 015000653
1500N/G5-6	23	/5-6	2 015000655

1501/1 - 2 - 3

thin leg pullers

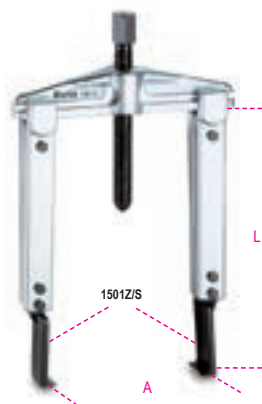

	L mm		
1501/1	100	1	015010101
1501/2	200	1	015010102
1501/3	250	1	015010103

	A min=Max mm
1501/1	25÷130
1501/2	25÷130
1501/3	25÷130

1501G/1 - 2 - 3

legs for item 1501



	L mm		
1501G/1	100	1	015010111
1501G/2	200	1	015010112
1501G/3	250	1	015010113

1501Z/S - P - R

leg ends for item 1501G



	\pm mm	D mm		
1501ZS	2.0	27	2	015010211
1501ZP	3.6	27	2	015010212
1501ZR	3.6	14	2	015010213

1505V

windshield and rear window wiper arm remover

Removable perforated brass tip for arm removal, with built-in washer jet

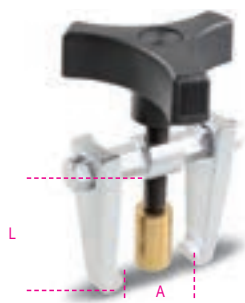

	A Max mm	L mm		
1505V	43	37	1	015050001

1505/C5

windshield wiper removal kit

1 two-leg puller, Ø 25÷40 mm
4 half-moon tools, Ø 25 mm, Ø 30 mm, Ø 35 mm, Ø 41 mm



mm	12	1	015050300

320x150x60 mm - 1,2 kg

1506

two-leg self-locking puller

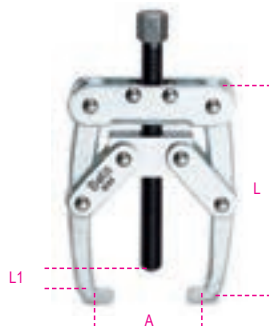

	A min=Max mm	L mm	L1 mm		
1506	10÷50	80	40	1	015060001

Beta

1508/1 - 1508/2

two-leg pullers, light series



	L mm		
1508/1	105	1	015080001
1508/2	130	1	015080002

	A min=Max mm	L1 mm
1508/1	6÷100	105
1508/2	10÷140	130

1511/1 - 2 - 3

external pullers with two reversible legs

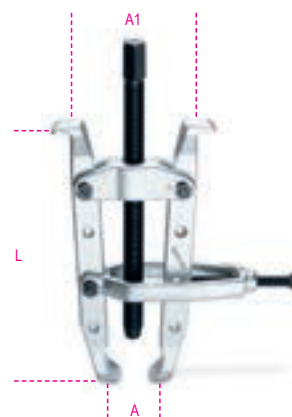

	L mm		
1511/1	235	1	015110001
1511/2	330	1	015110002
1511/3	405	1	015110003

	A min=Max mm	A1 min=Max mm
1511/1	20÷100	65÷95
1511/2	40÷150	103÷190
1511/3	40÷150	103÷175

Beta

1515/1 - 2 - 3

pullers with two floating legs

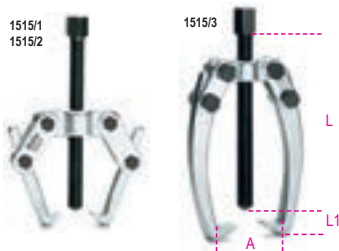

	L mm		
1515/1	85	1	015150101
1515/2	85	1	015150102
1515/3	105	1	015150103

	A Max mm	L1 mm
1515/1	60	105
1515/2	70	105
1515/3	90	105

1516/1 - 2 - 3

pullers with three floating legs



	L mm		
1516/1	85	1	015160001
1516/2	85	1	015160002
1516/3	105	1	015160003

	A Max mm	L1 mm
1516/1	60	85
1516/2	70	85
1516/3	90	105

1517

three-leg self-locking pullers

- For major pulling loads.
- Self-locking effect.



	L mm	L1 mm	Ø mm		
1517/90	182	60	22	1	015170000
1517/150	242	115	22	1	015170010
1517/200	307	150	22	1	015170020
1517/260	395	180	30	1	015170030

	● mm	A mm	kg	N
1517/90	19	18÷90	6000	59000
1517/150	19	25÷150	6000	59000
1517/200	19	40÷200	6000	59000
1517/260	27	50÷260	8000	78500

1518/...

three-leg pullers



	L mm		
1518/1	105	1	015180001
1518/2	135	1	015180002
1518/3	235	1	015180003
1518/4	270	1	015180004
1518/5	270	1	015180005
1518/6	270	1	015180006

	A min÷Max mm	L1 mm
1518/1	24÷100	105
1518/2	32÷160	150
1518/3	40÷220	220
1518/4	80÷250	240
1518/5	80÷300	350
1518/6	80÷350	400

1520/1 - 1520/2

pullers with two reversible legs

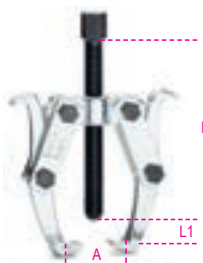

	L mm		
1520/1	135	1	015200101
1520/2	235	1	015200102

	A Max mm	L1 mm
1520/1	110	85
1520/2	160	140

1521/1 - 1521/2

pullers with three reversible legs

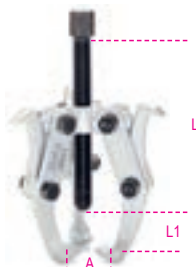

	L mm		
1521/1	135	1	015210101
1521/2	235	1	015210102

	A Max mm	L1 mm
1521/1	110	90
1521/2	160	140

1529

multi-step cone pulley puller

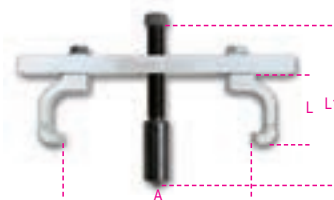

	A min÷Max mm	L min÷Max mm	L1 min÷Max mm		
1529	24÷240	60÷95	90÷135	1	015290000

260x210x60 mm - 2,6 kg

1529/C7

pulley puller

Kit contents:

- 2 legs with two 4.7-mm-thick feet
- 2 legs with one 4.3-mm-thick foot
- 1 leg with two 2.3-mm-thick feet
- 1 leg with one 2.3-mm-thick foot

The pair of legs can be made up according to one's operating requirements



	L mm	L1 mm	A min÷Max mm		
1529/C7	50	72,5	53÷114	1	015290100

285x155x50 mm - 2 kg

1529PI

universal injection pump pulley puller

- Allows fuel injection pump pulley to be quickly and accurately removed.
- Particularly suitable for Fiat, Ford, Volkswagen, Citroën and Peugeot vehicles.

Includes 3 pairs of screws for tightening puller to pulley:

- M6 x 1.0 x 49 mm
- M7 x 1.0 x 75 mm
- M8 x 1.25 x 76 mm



1529PI	1	015290051	

1530/C5

wheel hub and bearing pulling kit,
3, 4, 5 holes

Kit contents:

- 1 universal flange (96÷138 mm)
- 1 hydraulic screw (12 t)
- 1 hammer face (2.8 kg), required for hubs without central fixing bolts



1530/C5 1 015300300

760x320x120 mm - 11,5 kg

1530/C16

hammer face kit with spacing studs,
for pulling wheel hubs and bearings
3, 4, 5 holes

Ideal for hubs with projecting centre rings

Kit contents:

- 1 universal flange (90÷130 mm)
- 1 hammer face (5 kg)
- 4 M12 coupling studs
- 4 M14 coupling studs



1530/C16 1 015300316

760x310x100 mm - 13,5 kg

1532

packing and oil seal removal tool



1532 2 015320001

1533/...

pullers for separators 1534

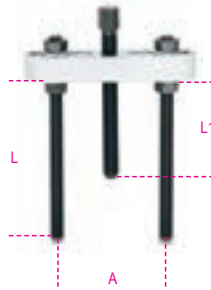

	L mm		
1533/2	150	1	015330002
1533/3	210	1	015330003
1533/4	315	1	015330004
1533/5	305	1	015330005

	A min+Max mm	L1 mm
1533/2	45÷140	110
1533/3	55÷205	175
1533/4	90÷260	175
1533/5	100÷360	235

1533PR/1 - 2 - 3

extensions for pullers 1533



1533PR/1	1	015330011
1533/2		
1533PR/2	1	015330012
1533/3		
1533PR/3	1	015330013
1533/4-5		

1534/...

separators

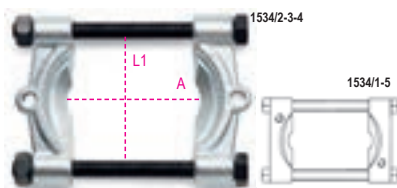

1534/1	1533/2	1	015340001
1534/2	1533/2	1	015340002
1534/3	1533/3	1	015340003
1534/4	1533/4	1	015340004
1534/5	1533/5	1	015340005

	A min+Max mm	L1 mm
1534/1	5÷60	63
1534/2	12÷75	75
1534/3	22÷115	118
1534/4	25÷155	154
1534/5	30÷220	230

1535/C...

puller kits



1535/C1 1 015350001

1533/2		
1533PR/1		
1534/1		

260x180x40 mm - 2,5 kg

1535/C2 1 015350002

1533/2		
1533PR/1		
1534/2		

260x180x40 mm - 2,8 kg

1535/C3 1 015350003

1533/3		
1533PR/2		
1534/3		

380x280x55 mm - 8,0 kg

1535/C4 1 015350004

1533/4		
1533PR/3		
1534/4		

420x380x65 mm - 14,8 kg

1535/C5 1 015350005

1533/5		
1533PR/3		
1534/5		

530x510x85 mm - 27,4 kg

1539

sheet sliding hammer



1539 1 015390001

1540

sliding hammer

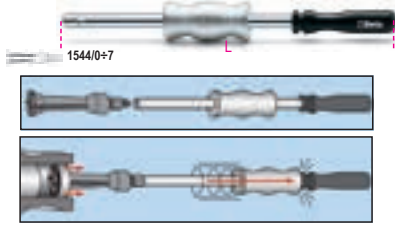

1540	390	M10	0÷7	1	015400001
------	-----	-----	-----	---	-----------

1542/1 - 1542/2

two-leg pullers for extractors



	A	min+Max	1544		
		mm			
1542/1	35÷75	0÷7		1	015420001
1542/2	60÷130	9C-10C		1	015420002

	A	min+Max	A1		
		mm	mm		
1542/1	35÷75	105			
1542/2	60÷130	160			

1544/...

internal extractors

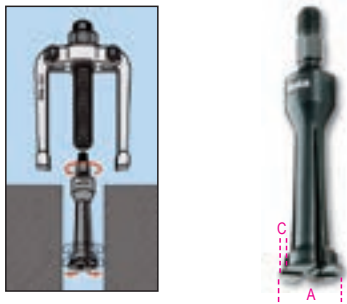

	C	mm	M		
1544/0	0,25	M10		1	015440100
A= 5÷7					
1544/A	0,80	M10		1	015440105
A= 7÷9					
1544/1	0,80	M10		1	015440110
A= 9÷12					
1544/2	1,15	M10		1	015440120
A= 13÷17					
1544/2B	1,00	M10		1	015440121
A= 14÷19					
1544/3	1,70	M10		1	015440130
A= 16÷21					
1544/4	1,65	M10		1	015440140
A= 20÷25					
1544/5	2,00	M10		1	015440150
A= 25÷30					
1544/6	3,00	M10		1	015440160
A= 30÷37					
1544/7	3,80	M10		1	015440170
A= 38÷45					
1544/9C	2,60	G 3/8"		1	015440189
A= 40÷75					
1544/10C	7,30	G 3/8"		1	015440199
A= 70÷115					

1545/C5M

puller 1542/1 with 5 extractors 1544



1545/C5M	1	015450011
----------	---	-----------

1542/1	● 24 mm
1544/1	9÷12 mm
1544/2	13÷17 mm
1544/3	16÷21 mm
1544/4	20÷25 mm
1544/5	25÷30 mm

265x180x45 mm - 2,4 kg

1547/C6

dummy ball bearing extractors



1547/C6	1	015470006
---------	---	-----------

420x185x60 mm - 3 kg

1547KP

set of 3 pairs of dummy ball terminals



	∅	mm			
1547KP/1	9-11-12,5			1	015470106
1547KP/2	5-6-8			1	015470206

1547P

hexagonal extensions



	L	mm	fit		
1547P/1	205	1547/1		1	015470101
1547P/2	102	1547/2		1	015470201

1547PC/2

round extensions, short series



	L	mm	fit		
1547PC/2	42	1547/2		1	015470202

1547PL/2

round extensions, long series



	L	mm	fit		
1547PL/2	106	1547/2		1	015470203

1548/C8

internal gearbox bearing puller for FCA and Opel group vehicles

comes with 2 pairs of legs and 4 different supports to adjust to different models manufactured since 2007



1548/C8	1	015480800
---------	---	-----------

1549

kit for removing and installing double effect shock absorbers with gas return allows stem to be kept straightened while springs are being installed



1549	1	015490001
------	---	-----------

310x270x110 mm - 3 kg

1550U

pneumatic shock absorber removal tool for cars, SUVs and commercial vehicles

CE

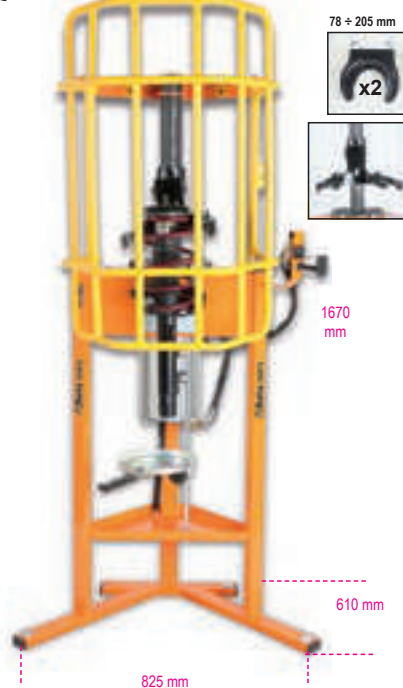

INCREASED POWER: maximum thrust 2 tons (10 bars)
UPPER UNIVERSAL HOLD SYSTEM: allows all left/right-hand spring diameters to be compressed with one upper adaptable plate.
ACTIVE SAFETY SYSTEM ON SPRING: safety hook and 3 locking valves allow spring to be properly positioned/seated, maintaining such position throughout compression.
If spring is not positioned properly, system will stop machine.
PROTECTIVE "FULL BODY" GRILLE: provides maximum safety and working area coverage
CONTROL LEVER OPERATION: increased accuracy and sensitivity during compression stage
WORKING POSITION: working height on rear fork raised up to 875 mm

Supplied with 2 lower forks for diameters 78-205 mm

TECHNICAL DATA

Maximum thrust: 2 tons (10 bars) - 1.6 tons (8 bars) - 1.2 tons (6 bars)
 Spring compression stroke: 335 mm

1550U 1 015500010

1550U/CGS-R

lowered upper jaws, pair, for item 1550U



1550U CGS-R 1 015500035

1550U/MRC-ABE

special forks for item 1550U, specially designed for Mercedes A-B-E Class cars



1550U/MRC-ABE 1 015500031

1550U/MRC-C

special forks for item 1550U, specially designed for Mercedes C class cars



1550U/MRC-C 1 015500032

1550U/S...

lower fork for item 1550U



	Ø mm		
1550U/S 130	78±130 mm	1	015500014
1550U/S 182	105±182 mm	1	015500015
1550U/S 205	125±205 mm	1	015500016

1550U/SS187

left-hand fork for item 1550U

Particularly suitable for left-hand springs, e.g. Nissan Qashqai and Renault Koleos



1550U/SS 187 1 015500018

1550U/M

vice for shock absorber removal tool item 1550U

Allows shock absorber stem to be locked



1550U/M 1 015500021

1555/Q

compressor for MacPherson and equivalent shock absorber springs

Maximum thrust: 1500 kg

CE

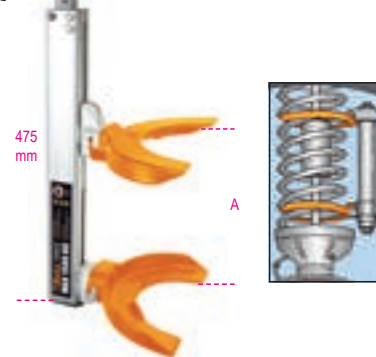

A	Ø		
min+Max mm	min+Max mm		
65±354	80±195	1	015550006

1555/QS

compressor for MacPherson and equivalent shock absorber springs

CE

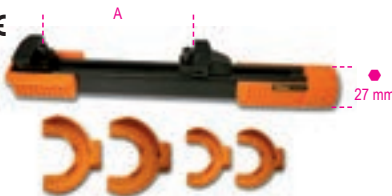

A	Ø		
min+Max mm	min+Max mm		
70±300	80±200	1	015550005

1555S/BMW-RNT

fork for BMW E39, E46 and Renault Mégane II shock absorbers, for items 1555Q and 1555/QS



1555S/BMW-RNT 1 015550303

1555C

telescopic compressor for shock absorber springs with 4 forks and torsion bar

12"



A	Ø	N	t		
min+Max mm	min+Max mm				
80±225	90±160	25000	8,5	1	015550202

1556/1A

compressor for shock absorber springs

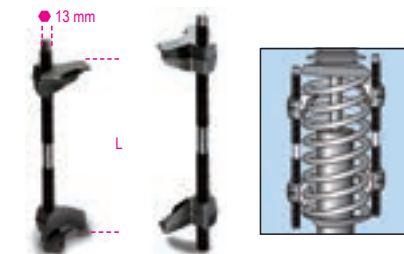

min L	Max		
mm	mm		
65	320	1	015560101

1556/2A

compressor for shock absorber springs

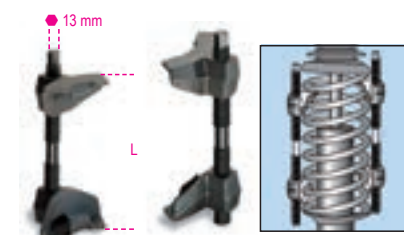

min L	Max		
mm	mm		
65	200	1	015560102

1557

impact sockets for truck leaf springs



L	L1		
mm	mm		
37	28	1	015570137
46	34	1	015570146
56	34	1	015570156

1557V

impact sockets for Volvo leaf springs



mm			
27		1	015570299

1557/S3

set of 3 sockets for shock absorber nuts

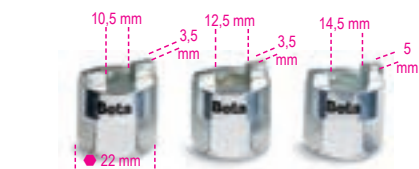

1557/S3		1	015570010
---------	--	---	-----------

1558/C4

internal and external snap ring tool, screw-operated

square drive allows a high force to be applied in both operating conditions
Supplied tips: Ø 2.5-3-3.5 mm



1558/C4	5,5 ÷ 77	5,5 ÷ 77	1	015580100
---------	----------	----------	---	-----------

330x220x50 mm - 900 g

1558P

snap ring tips, pair, for item 1558



Ø			
mm			
2,5		1	015580125
3,0		1	015580130
3,5		1	015580135

1559

ball joint puller, light series

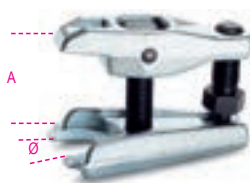

	A Max	Ø		
	mm	mm		
1559/22	50	18÷22	1	015590001
1559/36	90	36	1	015590036
1559/45	115	45	1	015590045

1559V/8T

hydraulic screw for ball joint pullers 1559/36 and 1559/45



Nm	t		
80000	8	1	015590145

1560/1 - 1560/2

ball joint pullers, professional type



	A	Ø		
	min+Max	mm		
1560/1	12÷50	20	1	015600001
1560/2	60÷85	20	1	015600002

1560A

ball joint puller



1560A		1	015600601
-------	--	---	-----------

1561/...

ball joint pullers

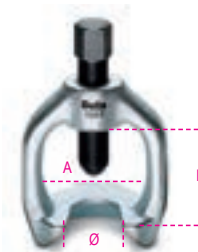

	L	A	Ø	
	mm	mm	mm	
1561/1	39	36,6	18	1 015610001
1561/2	47	45,7	25	1 015610002
1561/3	63	62	30	1 015610003
1561/4	75	63	40	1 015610004

1562D

ball joint puller

Supplied with 2 screws for pulling suspension and steering joints

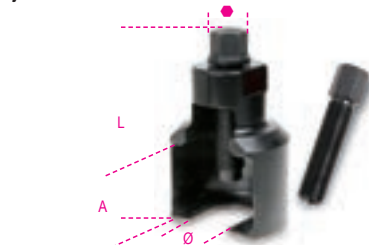

A max	Ø	●	L	
mm	mm	mm	mm	
50	39	26	155	1 015620239

1565/1 - 2 - 3

fork separators for ball joints



	Ø	L1		
	mm	mm		
1565/1	18	65	1	015650001
1565/2	23	65	1	015650002
1565/3	30	88	1	015650003

1566N

tool for removing/installing steering arms



Ø x L mm	mm	mm			
28÷35 x 400	27	12"		1	015660005
35÷45 x 190	27	-		1	015660008
35÷45 x 400	27	12"		1	015660010

1566/G01

homokinetic joint puller

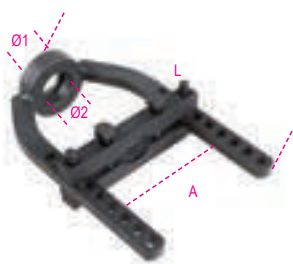

L mm	A mm	Ø1 mm	Ø2 mm		
250	115	29	36	1	015660052

1566P

ribbed axle shaft
circlip pliers

Pliers compress circlip, making it easier to fix axle shaft into homokinetic joint



L mm	A Max mm		
280	36	1	015660091

1567

lever for removing wishbone heads
and shock absorbers from pillar

Can be used by one operator



A mm	B min+Max mm		
1060	100÷300	1	015670001

1569/A

assortment of tools for removing and installing
rear axle silent blocks,
driving shaft oil seals and wheel bearings

- Bushings can be used both on vehicle and on hydraulic press
- Kit contents:
4 threaded bars: M10-M12-M14-M16
4 washers
bushings for diameters ranging from 44 mm to 82 mm



1569/A 1 015690011

530x415x115 mm

1569/B

assortment of tools for removing and installing
silent blocks, oil seals and wheel bearings

diameter: 14÷32 mm



1569/B 1 015690015

1569/F

tool assortment for removing and inserting
Fiat Panda, Fiat 500 and Ford Ka silentblocks



1569/F 1 015690021

1569CP

striking tools
for installing conical bearings and oil seals

Quick adjustment



	Ø min+Max mm	L mm		
1569CP/50	9,5÷50	130	1	015690750
1569CP/90	18÷90	145	1	015690790

1570/3

hydraulic presses for pullers



t	L mm	L1 mm	mm		
30	243	36	19	1	015700003

1580/8I

two-leg hydraulic puller

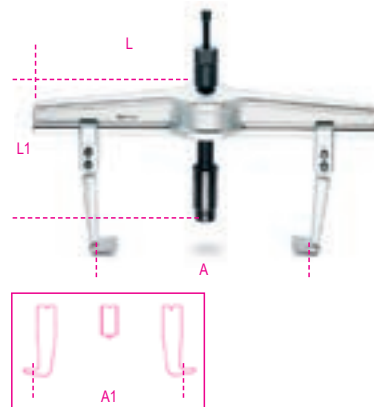

1580/8I 1 015800008

	A min+Max mm	L mm	L1 mm	A1 min+Max mm	N Max
1580/8I	170÷640	715	280	260÷715	180000

1580GL

loose legs, long series, for pullers item 1580/8I



	L mm		
1580GL/8A	300	1	015800227
1580GL/8B	400	1	015800228
1580GL/8C	500	1	015800229

1585/5I - 6I - 7I

three-leg pullers for hydraulic use

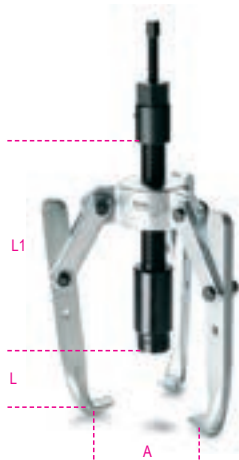

1585/5I	1	015850005
1585/6I	1	015850006
1585/7I	1	015850007

	A min+Max mm	L1 mm	L mm	N Max
1585/5I	50=350	135	280	150000
1585/6I	50=350	235	280	150000
1585/7I	50=350	335	280	150000

1585GI/5 - 6 - 7

legs for hydraulic puller
1585/I-1585/6I-1585/7I

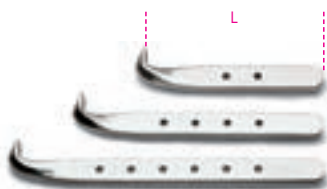

	L mm		
1585GI/5	135	1	015850205
1585GI/6	235	1	015850206
1585GI/7	335	1	015850207

1589VI

hydraulic screw for pullers
1580/8I and 1585/5I - 1585/6I - 1585/7I

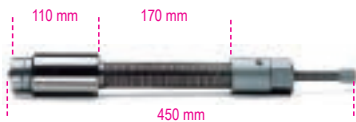

1589VI	1	015890001
--------	---	-----------

1589PI/50 - 100 - 150

extension sockets for hydraulic screw

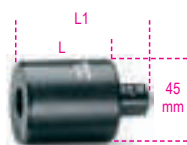

	L mm	L1 mm		
1589PI/50	50	70	1	015890005
1589PI/100	100	120	1	015890010
1589PI/150	150	170	1	015890015

1590

standard clamps



A max mm	L1 mm		
60	55	2	015900305
80	65	2	015900307
100	65	2	015900310
120	85	2	015900312
150	95	2	015900315

1591

screw clamps



A	A max mm	L1 mm		
200	200	80	2	015910020
300	310	85	2	015910030
400	410	85	2	015910040
500	500	95	2	015910050
600	600	95	2	015910060
800	800	95	2	015910080
1000	1000	110	2	015910100

1593

screw clamps

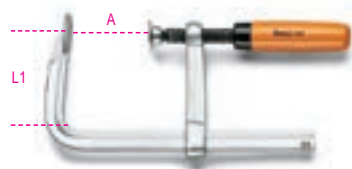

A	A max mm	L1 mm		
160	170	80	2	015930016
200	240	100	2	015930020
300	320	145	2	015930030

1594

lever bar clamps



A	A max mm	L1 mm		
200	240	145	1	015940020
250	290	145	1	015940025
300	340	145	1	015940030
400	430	150	1	015940040
500	530	150	1	015940050
600	630	150	1	015940060

1595

screw clamps

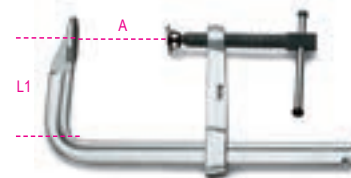

A	A max mm	L1 mm		
200	230	100	2	015950020
250	270	120	2	015950025
300	330	120	2	015950030
400	420	120	2	015950040
500	520	125	2	015950050
600	620	125	2	015950060
800	820	125	1	015950080
1000	1030	125	1	015950100

1599F

parallel bench vices

with hardened top and slides

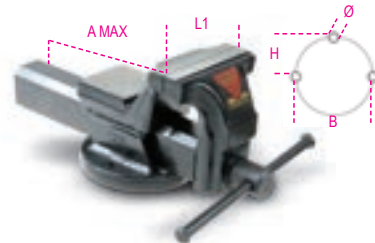

L1 mm	BxH mm	Ø mm	A MAX mm		
100	92x46	11	125	1	015990100
125	108x54	13	150	1	015990125
150	125x62	13	200	1	015990150
175	140x70	15	220	1	015990175

1599P

parallel bench vices

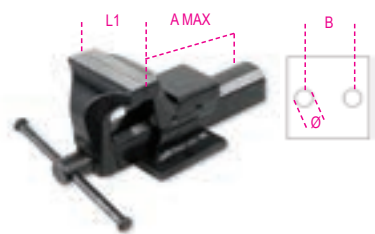

L1 mm	B mm	Ø mm	A MAX mm		
100	92	11	111	1	015990000
125	108	13	130	1	015990025
150	130	15	170	1	015990050

1599B

revolving bases for vices item 1599P



	1599P		
1599B 100	100	1	015990810
1599B 125	125	1	015990812
1599B 150	150	1	015990815

1599T

parallel drill vices

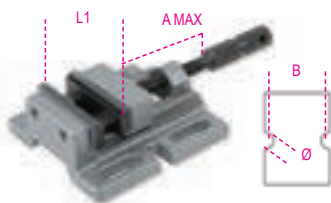

L1 mm	B mm	Ø mm	A MAX mm		
80	111	11	65	1	015990480
100	120	13	87	1	015990500

1599G

pairs of aluminium jaw covers



A mm		
100	1	015990910
125	1	015990912
150	1	015990915
180	1	015990917

1601/PC

ratchet crimping pliers for telephone terminals and data transmission

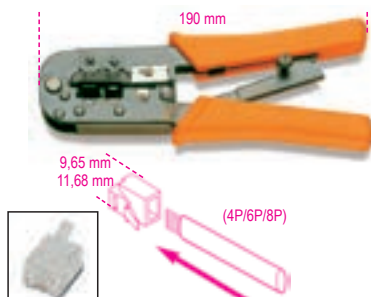

RJ11-RJ12-RJ45	2	016010011

1602

crimping pliers for insulated terminals, light series



mm ²		
0,75÷6	5	016020001

1602/C9

crimping pliers, light series, with assortment of 900 terminals



1602/C9	1	016020045

1602		n.
BM00180	R/6,3	1
BM00280	B/6,3	50
BM00380	G/6,3	50
BM00191	R/6,3	50
BM00291	B/6,3	50
BM00392	G/6,3	50
BM00160	R/1,6	50
BM00260	B/2,3	50
BM00360	G/3,6	50

420x350x35 mm - 1,5 kg

1602A

crimping pliers for insulated terminals, standard model

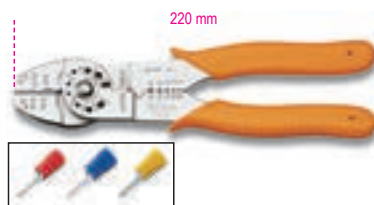

mm ²		
0÷6	2	016020005

1603

crimping pliers for non-insulated terminals, light series

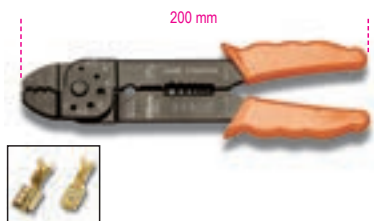

mm ²		
1,25÷5,5	5	016030001

1603A

crimping pliers for non-insulated closed terminals, standard model

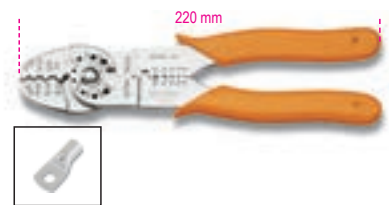

mm ²		
0÷8	2	016030005

1603B

crimping pliers for non-insulated open terminals, standard model

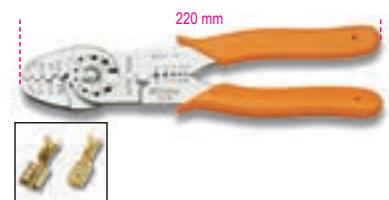

mm ²		
0÷8	2	016030010

1604

self-locking pliers for insulated terminals



mm ²		
0,5÷6	1	016040001

1604/C9

self-locking pliers with assortment of 900 terminals



1604/C9	1	016040045

1604		n.
BM00180	R/6,3	1
BM00280	B/6,3	50
BM00380	G/6,3	50
BM00191	R/6,3	50
BM00291	B/6,3	50
BM00392	G/6,3	50
BM00160	R/1,6	50
BM00260	B/2,3	50
BM00360	G/3,6	50

420x350x35 mm - 2 kg



1605

self-adjusting pliers
for non-insulated terminals

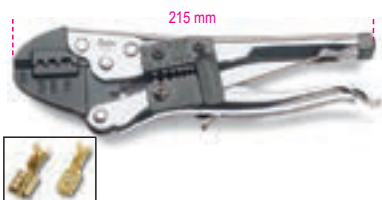

mm²
0,5÷6

1 016050001

1606

heavy duty crimping pliers
for cylindrical terminals



mm²
0,5÷6

1 016060001

1606A

crimping pliers for tubular terminals



1606A6 0,5÷6 1 016060010
1606A16 6÷16 1 016060016

1606A/C9

crimping pliers for tubular terminals
with assortment of 450 terminals, 0,5÷6 mm²



1606A/C9 1 016060045

1606A6	n.
BM00601 W/0,5	50
BM00604 N/1,5	100
BM00506 B/2,5	100
BM00508 G/4	100
BM00610 Y/6	100

420x350x35 mm - 2,5 kg

1606T

crimping pliers for tubular terminals, 4-sided
crimping
reduced lever stress



mm²
0,1÷10

1 016060005

1607

heavy duty crimping pliers
for BNC coaxial wires RG 58, RG 59,
RG 62, RG 71

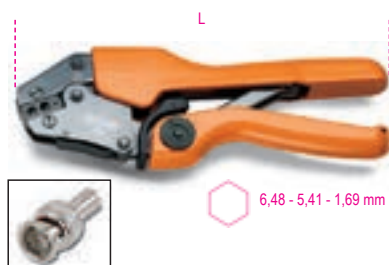

1607	L mm	A mm	B mm
	220	73	19

1 016070001

1608

crimping pliers for insulated terminals,
with pressure regulator

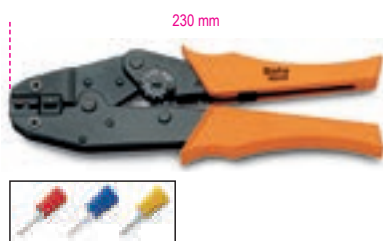

mm²
0,5÷6

1 016080001

1608/C9

pliers
with assortment of 900 terminals



1608/C9 1 016080045

1608	n.
BM00180 R/6,3	50
BM00280 B/6,3	50
BM00380 G/6,3	50
BM00191 R/6,3	50
BM00291 B/6,3	50
BM00392 G/6,3	50
BM00160 R/1,6	50
BM00260 B/2,3	50
BM00360 G/3,6	50

420x350x35 mm - 2 kg

1608A

heavy duty crimping pliers
for insulated terminals



mm²
0,75÷6

1 016080005

1609

crimping pliers for non-insulated
terminals, professional model
fast performance



mm²
0,5÷2,5

1 016090001

Beta

1609A

heavy duty crimping pliers
for non-insulated terminals



255 mm



mm ²		
0,5÷6	1	016090005

1609B

crimping pliers for noninsulated terminals

punch crimps,
10 mm² ÷ 120 mm²



L



L mm	mm ²	
600	10÷120	1 016090101

1609C/C5

oil-pressure crimping pliers
with 5 pairs of dies

hexagonal crimps,
25 mm² ÷ 240 mm²



mm ²		
50÷240	1	016090210

500x300x110 mm - 4 kg

1609M

dies for item 1609C

hexagonal crimps



	mm ²	
1609M/16	10-16	1 016090221
1609M/35	25-35	1 016090223
1609M/70	50-70	1 016090225
1609M/120	95-120	1 016090227
1609M/150	150	1 016090229
1609M/185	185	1 016090231
1609M/240	240	1 016090233

1639S

nylon wire puller

with interchangeable heads



L m	∅ mm	
10	4	1 016390010

1640K

oil-pressure punching machine with 4 punches

round punches
22.5-25.5-32.5-55.5 mm



1640K	1	016400001
-------	---	-----------

470x400x100 mm

1640

sheet metal punch press



340 mm

1640	1	016400100
------	---	-----------

1640A

adapter for item 1640



1640A	1	016400080
-------	---	-----------

1640P

threaded pin for item 1640



	∅ mm	
1640P/9	9,5	1 016400088
1640P/19	19	1 016400089

1640Q

square punches for item 1640



	mm	
1640Q 45	45x45	1 016400065

1640T

round punches for item 1640

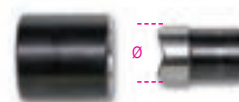

	∅ mm	
1640T 22,5	22,5	1 016400022
1640T 25,5	25,5	1 016400025
1640T 32,5	32,5	1 016400032
1640T 55,5	55,5	1 016400055

1650

sliding gauge
reading to 0.05 mm



UNI EN ISO 13385-1DIN 862

A max mm	L mm	
150	235	1 016500001
200	290	1 016500002

1650FD

sliding gauge for brake discs
reading to 0.1 mm

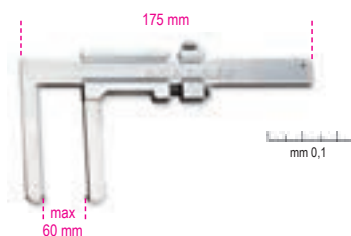

1650FD	1	016500050
--------	---	-----------

1650FT

sliding gauge for brake drums
made from stainless steel
reading to 0.05 mm



	A max mm	L mm		
1650FT/1	350	438	1	016500060
1650FT/2	500	550	1	016500070

1651DGT

digital vernier
reading to 0.01 mm

- Reading to 0.01 mm
- Screw slider locking
- mm/inch conversion



UNI EN ISO 13385-1DIN 862CE

A Max mm	L mm		
150	225	1	016510111
200	285	1	016510112

1651DGT/IP

digital vernier,
reading to 0.01 mm, degree of protection IP67

Total protection against dust and liquids; it also works when it is completely immersed.



UNI EN ISO 13385-1 DIN 862CE

1651DGT/IP		
270x115x35 mm - 450 g	1	016510611

1652

analogue vernier,
analogue reading to 0.02 mm



UNI EN ISO 13385-1DIN 862

1652	1	016520016
------	---	-----------

1654

workshop verniers,
reading to 0.02 mm



UNI EN ISO 13385-1DIN 862

A max mm	L mm		
200	330	1	016540020
300	410	1	016540030

1654DGT

digital vernier,
reading to 0.01 mm
reading to 0.0005"

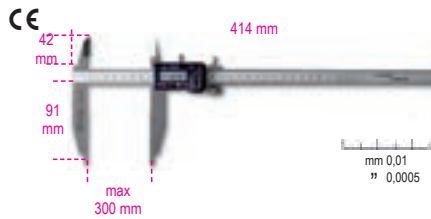

UNI EN ISO 13385-1DIN 862CE

1654DGT	1	016540111
---------	---	-----------

1656

depth gauge, reading to 0.02 mm



UNI EN ISO 13385-2DIN 862

A max mm	L mm		
200	260	1	016560020
300	360	1	016560030

Beta

1657DGT/2

digital depth gauge
reading to 0.01 mm
reading to 0,0005"

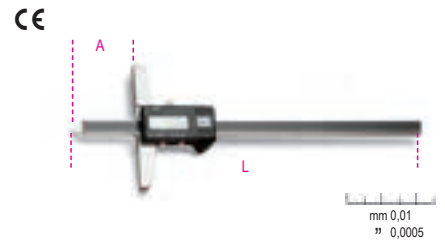

UNI EN ISO 13385-2DIN 862CE

1657DGT/2	A max mm	L mm		
	200	270	1	016570002

1658/...

outside micrometers,
reading to 0.01 mm



DIN 863/II

	A mm		
1658/25	0÷25	1	016580025
1658/50	25÷50	1	016580050
1658/75	50÷75	1	016580075
1658/100	75÷100	1	016580100

1658/C4

assortment of 4 micrometers
item 1658



DIN 863

1658/C4	1	016580001
---------	---	-----------

1658/25	0÷25 mm
1658/50	25÷50 mm
1658/75	50÷75 mm
1658/100	75÷100 mm

365x245x35 mm - 2,5 kg

Beta

1658DGT

outside micrometers,
reading to 0.001 mm

CE



DIN 863CE

	A mm		
1658DGT25	0÷25	1	016580325
1658DGT50	25÷50	1	016580350

1658SP/1

base for micrometer



1658SP/1	1	016580910
----------	---	-----------

1659

thickness gauge with dial indicator,
reading to 0.01 mm.

C=dial field



	C mm		
1659	0÷10	1	016590001

1662/1 - 1662/2

dial indicator, reading to 0.01 mm

C=dial field



	C mm		
1662/1	0÷5	1	016620001
1662/2	0÷10	1	016620010

1662DGT/A

digital dial indicator,
reading to 0.01 mm
C = Dial field

CE



	C mm		
1662DGT/A	0-12,5	1	016620311

1662AN

adjustable stylus dial indicator,
reading to 0.01 mm

C=Dial field



	C mm		
1662AN	0÷0,8	1	016620200

1662SP0

magnetic base



1662SP0	1	016620800
---------	---	-----------

1662SP2

magnetic base, rotating



1662SP2	1	016620910
---------	---	-----------

1666

precision squares
made from stainless steel ground
and lapped



DIN 875/0			
L mm	L1 mm		
100	70	1	016660210
150	100	1	016660215
200	130	1	016660220
250	165	1	016660225
300	200	1	016660230

1666A

flanged precision squares
made from stainless steel ground
and lapped



DIN 875/0			
L mm	L1 mm		
100	70	1	016660110
150	100	1	016660115
200	130	1	016660120
250	170	1	016660125
300	200	1	016660130

1668

squares
made from normalized,
ground steel



DIN 875/2

L mm	L1 mm		
100	70	2	016680210
150	100	2	016680215
200	130	2	016680220
250	165	1	016680225
300	174	1	016680230

1668A

flanged precision squares
made from normalised, ground steel



DIN 875/2

L mm	L1 mm		
100	70	2	016680110
150	100	2	016680115
200	130	2	016680120
250	165	1	016680125
300	176	1	016680130

1670

squares
made from ground steel



L mm	L1 mm		
100	70	3	016700010
150	100	3	016700015
200	130	3	016700020
250	160	3	016700025
300	175	3	016700030
400	230	2	016700040
500	280	2	016700050
600	330	2	016700060
800	420	1	016700080
1000	500	1	016700099

1670A

flanged precision squares
made from ground steel



L mm	L1 mm		
100	70	3	016700110
150	100	3	016700115
200	130	3	016700120
250	165	3	016700125
300	175	3	016700130
400	230	2	016700140
500	280	2	016700150
600	330	2	016700160
700	375	1	016700180
1000	500	1	016700199

1672

mitre square, adjustable sliding blade,
base and blade made from steel

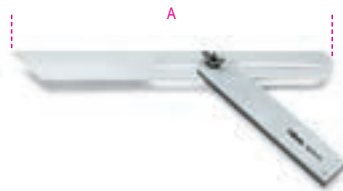

A mm			
300	2	016720030	

1672A

mitre square, adjustable,
sliding blade, aluminium base,
blades made from chrome-plated steel

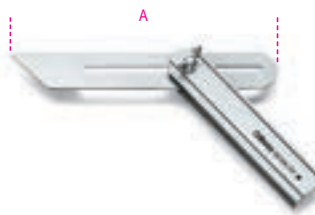

A mm			
200	3	016720120	
300	3	016720130	

Beta

1674A

carpenter's squares blades
made from stainless steel,
with aluminium bases, double metric scale



L mm	L1 mm		
300	169	2	016740130
400	214	2	016740140

1676

protractors made from stainless steel

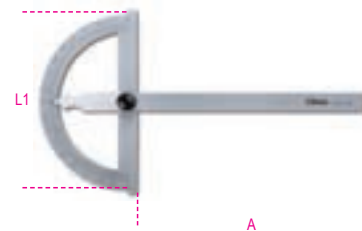

A mm	A mm	L1 mm	G mm		
120	120	80	1°	2	016760012
150	165	120	1°	2	016760015
200	210	150	1°	2	016760020
300	310	200	1°	1	016760030

1678/C3

bevel protractor
made from stainless steel

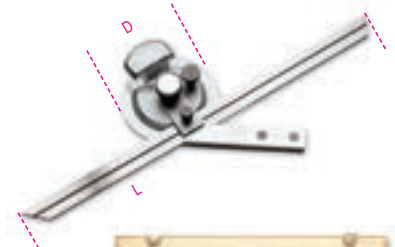

L Max mm	D mm		
300	70	1	016780030

1679

universal gauge with contact-roll, made from stainless steel, reading to 0.1 mm

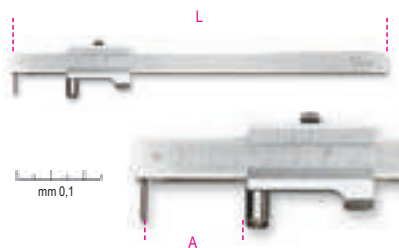

L mm	A Max mm		
235	200	1	016790020

1679/PR

spare tip for universal gauge 1679



1679/PR	1	016790021
---------	---	-----------

1680

trammels, hardened steel body and tips

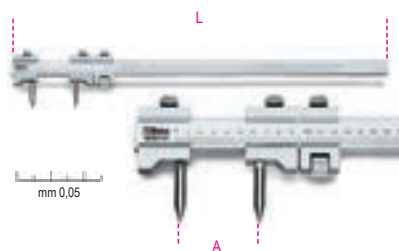

L mm	A Max mm		
660	500	1	016800050

1680A

inside callipers



L mm	A Max mm		
150	144	2	016800115
200	200	2	016800120
250	245	1	016800125
300	300	1	016800130

1680B

outside callipers



L mm	A Max mm		
150	155	2	016800215
200	190	2	016800220
250	235	1	016800225
300	280	1	016800230

1680C

precision dividers, hardened steel straight tips



L mm	A Max mm		
150	138	2	016800315
200	190	2	016800320
250	235	1	016800325
300	280	1	016800330

1682

flexible graduated rules made from stainless steel

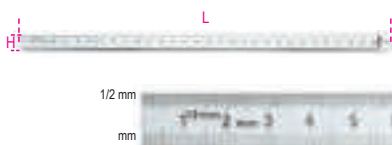

L mm	H mm	$\pm \frac{\Delta}{\Delta}$ mm		
150	13	0,5	5	016820015
200	13	0,5	5	016820020
250	13	0,5	5	016820025
300	13	0,5	5	016820030
500	13	0,5	2	016820050
1000	13	0,5	2	016820100

1683

semi-rigid graduated rules made from stainless steel



L mm	H mm	$\pm \frac{\Delta}{\Delta}$ mm		
300	30	1	5	016830030
500	30	1	2	016830050
1000	30	1	2	016830100
1500	30	1	1	016830150

1685/C7

assortment of 7 measuring and marking tools



1685/C7

1 016850110

1650	160 mm
1658/25	0÷25 mm
1670	100 mm
1680C	150 mm
1682	150 mm
1688BC	165 mm
1688BC/R	

320x210x37 mm - 1,2 kg

1687A

engineer's precision scribe, tip bent at 90°, with handle

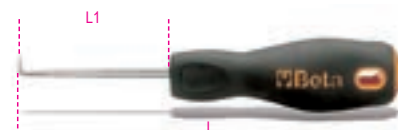

1687A	L mm	L1 mm		
	153	80	1	016870120

1687AC

engineer's precision scribe, short tip bent at 90°, with handle

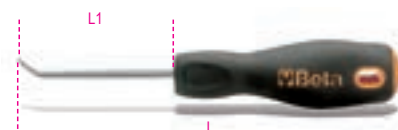

1687AC	L mm	L1 mm		
	153	80	1	016870125

1687D

engineer's precision scribe, straight tip, with handle

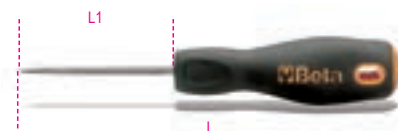

1687D	L mm	L1 mm		
	153	80	1	016870110

1687U

engineer's precision scriber,
hook tip, with handle

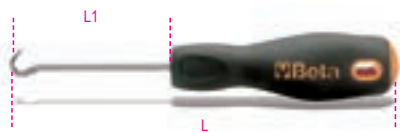

	L mm	L1 mm		
1687U	153	80	1	016870115

1687/S4

set of 4 engineer's precision scribers,
with handles



1687S4	1	016870150
1687A-1687AC		
1687D-1687U		

1688

engineer's scriber
made from hardened steel



	L mm	∅ mm		
1688	250	2	5	016880020

1688A

engineer's scriber
made from hardened steel



	L mm	∅ mm		
1688A	200	4	5	016880120

1688PC

engineer's scriber
made of chrome-plated, hardened steel



	L mm	∅ mm		
1688PC	150	1	1	016880300

1688PC/R

spare tip for item 1688PC



1688PC/R	1	016880310
----------	---	-----------

1688M

carpenter's pencil



	L mm		
1688M	180	50	016880880

1690F

folding ruler made of fibreglass
precision class III

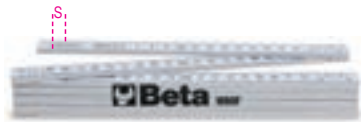

	L m	S mm		
1690F/2	2	17	5	016900220

1690L

folding ruler made of birch
precision class III



	L m	S mm		
1690L/2	2	17	5	016900200

1691BM

measuring tapes
shock-resistant bimaterial ABS casings,
steel tapes,
precision class: II

CE



	L m	S mm		
1691BM/5	5	25	1	016910205
1691BM/8	8	32	1	016910208
1691BM/10	10	32	1	016910210

1692

measuring tapes,
shock-resistant bi-material ABS casings,
steel tapes,
precision class II

CE



	L m	S mm		
1692/2	2	16	5	016920052
1692/3	3	16	5	016920053
1692/5	5	19	5	016920055
1692/8	8	25	5	016920058

1694/L

measuring tapes shock-resistant
ABS casings, PVC-coated fibreglass tapes,
precision class III

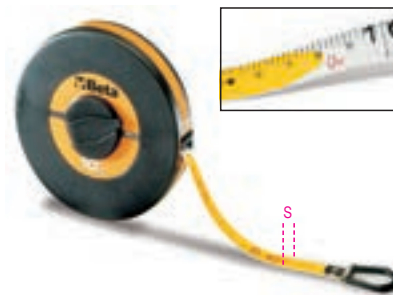

	L m	S mm		
1694L10	10	13	1	016940110
1694L20	20	13	1	016940120

1694A/L

measuring tapes with handles,
shock-resistant ABS casings,
PVC-coated fibreglass tapes,
precision class III



	L m	S mm		
1694A/L30	30	13	1	016940230
1694A/L50	50	13	1	016940250

1694B/L

measuring tape with handle,
aluminium casing, varnished steel tape,
precision class II



	L m	S mm		
1694B/L50	50	12,5	1	016940350

Beta

1695XS

pocket spirit level with magnetic V-shaped base
made from profiled aluminium
2 unbreakable vials
accuracy: 1mm/m

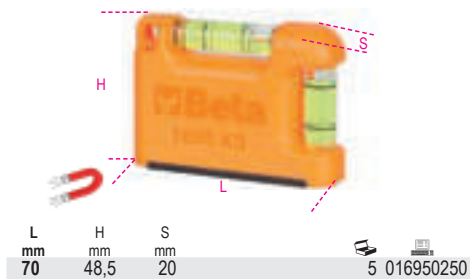

1696

spirit levels made from anodized profile aluminium, with 2 unbreakable vials,
accuracy: 1 mm/m

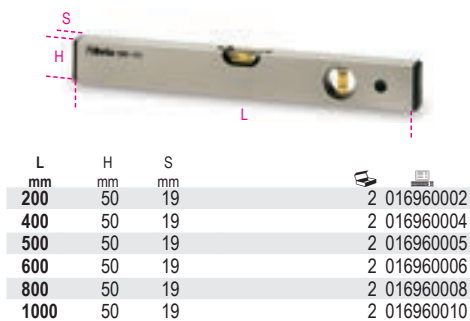

1696A

spirit levels made from die-cast aluminium, with 1 ground base
and 2 unbreakable vials, accuracy: 1 mm/m

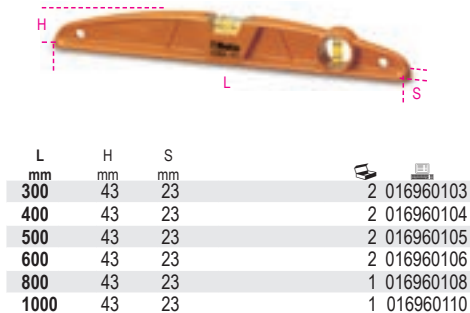

1696B

spirit levels with magnetic bases
made from anodized profiled aluminium,
2 unbreakable vials accuracy: 1 mm/m

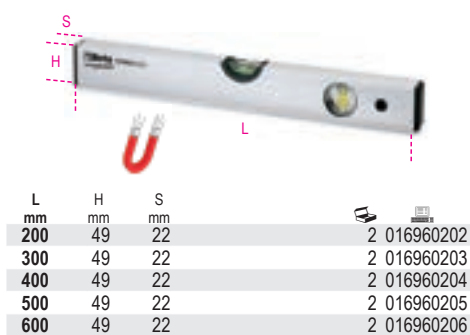

1696D

spirit levels made of die-cast aluminium with
handles,
4 ground bases and 3 unbreakable vials,
accuracy: 1 mm/m

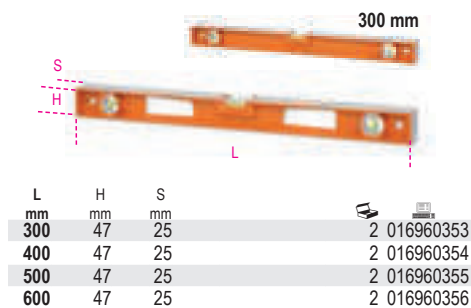

1696S

levelling staffs made from aluminium, with 2
unbreakable vials

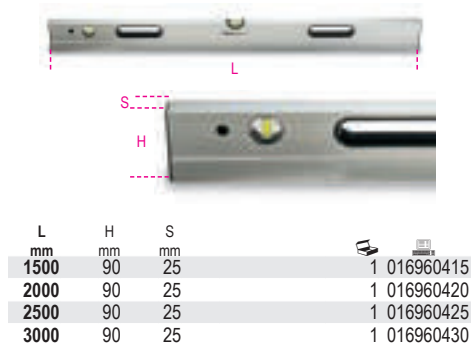

1699L

precision surface level made from
die-cast iron with ground prismatic
base, 2 unbreakable vials,
accuracy: 0.05 mm/m



1699L/1

precision surface level made
from die-cast iron with ground prismatic
base, 2 unbreakable vials,
accuracy: 0.02 mm/m



1699Q

precision square levels made from
die-cast iron with 2 prismatic bases
and 2 ground flat bases, 2 unbreakable vials,
accuracy: 0.05 mm/m

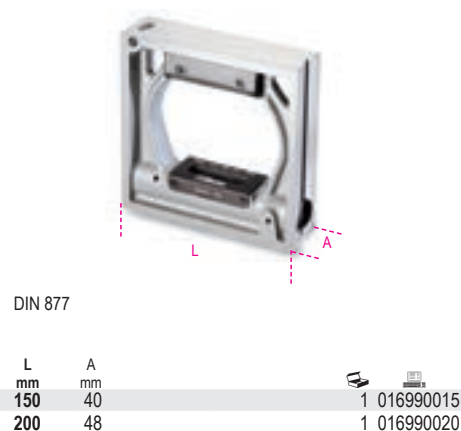

1700N

masonry points



1700N/PM

masonry points
with hand guards



1701N

masonry chisels

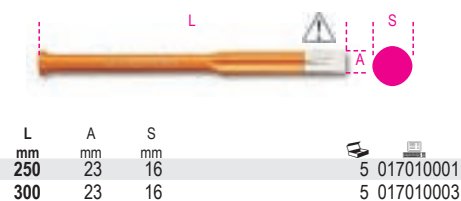

1701N/PM

masonry chisels
with hand guards

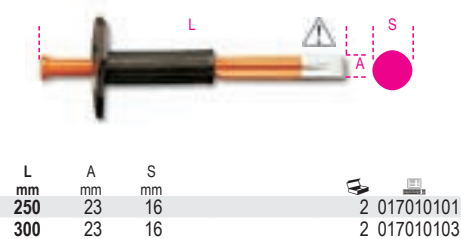

1701PMR

hand guards for items 1700N and 1701N

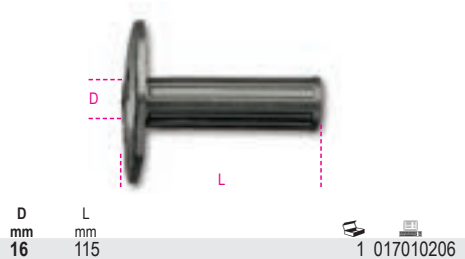

1701NE/...

electrician's chisels

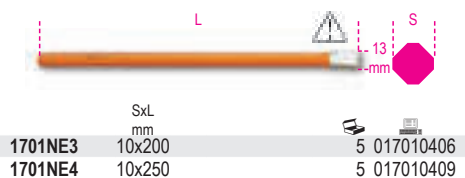

1702N

extra-wide chisels

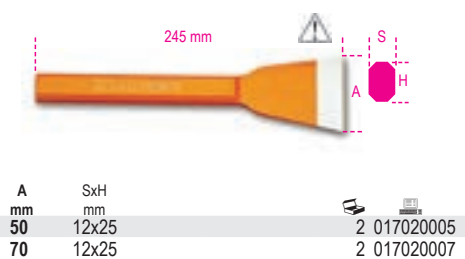

1702N/PM

extra-wide chisels with hand guards

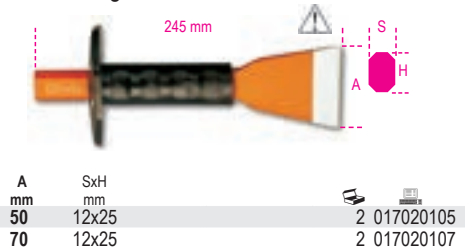

We recommend frequent cooling of the tool while regrinding it.

1702PMR

hand guard for item 1702N



1704

carpenter's wrenching bars

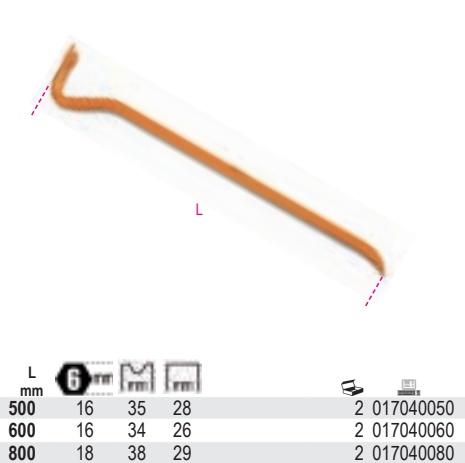

1704A

crow bars with open and pointed edges

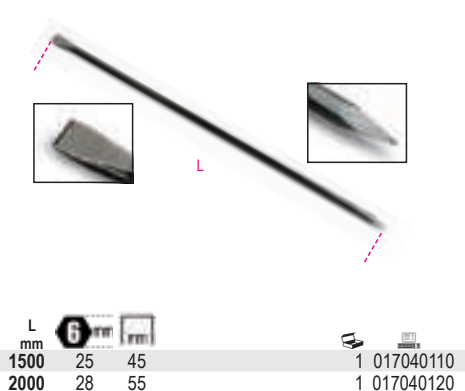

1704C

crow bars with closed and pointed edges



1705

chalk line reel made from aluminium



1705PT

chalk powder



1706DGT

digital depth gauge for tyre threads



1707

screw pitch gauge

For ISO 60° metric and Whitworth 55° threads



1707A/1 - 2 - 3

radius gauges, concave and convex steel blades

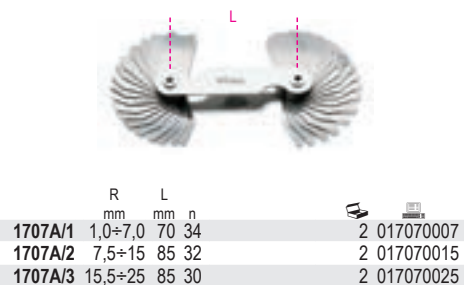

1708/8 - 13 - 20

metric feeler gauges



1708/8	S = 0,05±0,50 mm	5	017080008
1708/13	S = 0,05±1,00 mm	5	017080013
1708/20	S = 0,05±1,00 mm	5	017080020

1709/10 - 1709/18

nut splitters



	L mm	A max mm	
1709/10	90	17 (M10)	1 017090010
1709/18	108	25 (M16)	1 017090018

1710

hydraulic nut splitters



	C min mm	C max mm	
7(M4)	7	22(M14)	1 017100001

1712E/1 - 2 - 3

flexible magnetic pick up tools

F = magnetic power



	L mm	D mm	F kg	
1712E/1	420	7,5	0,5	2 017120011
1712E/2	530	15	1,8	2 017120012
1712E/3	532	19	3,0	2 017120013

1712E/L1

flexible magnetic pick-up tool with LED light

F = magnetic force
Battery: 2xLR48

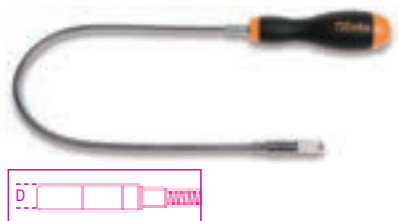

	L mm	D mm	F kg	
1712E/L1	500	11	0,75	2 017120111

1712E/R-L1

spare heads for item 1712E/L1, with LED and magnet

1712E/R-L1	1	017120611
------------	---	-----------

1712TF

telescopic magnet with flexible head

• With washer jet cleaner
F = magnetic force



	L mm	D mm	F kg	
150÷590	11	1	1 017120600	

1713M

flexible pickup tools



	L mm	D mm	
500	7	2 017130011	
1000	7	1 017130015	

1714

inspection mirror made from plastic



	L mm	D mm	
1714	155	25	5 017140001

1715

telescopic joint inspection mirror
chrome-plated metal body



	L mm	D mm	
1715	180÷540	30	1 017150001

1715FL/A

square flexible inspection mirror



	L mm	A mm	B mm	
1715FL/A	600	53	90	1 017150110

1715R/FL

kit of 2 inspection mirrors for items 1715FL/A and 1715FL/B

1715R/FL	1	017150151
----------	---	-----------

1715FL/B

rectangular flexible inspection mirror
with light

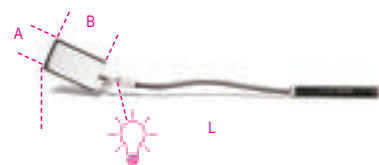

	L mm	A mm	B mm	
1715FL/B	553	53	90	1 017150115

1715B/R5L

kit of 5 spare light bulbs for item 1715FL/B

1715B/R5L	1	017150152
-----------	---	-----------

1716A

angled bit for general use



	L mm	L1 mm	mm	
1716A	240	125	6	3 017160040

1716P

packing scraper



	L mm	L1 mm	mm	
1716P	250	125	6	3 017160020

1716Q

square bit reamer

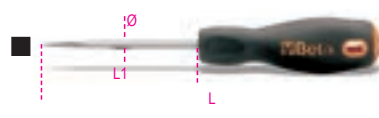

	L mm	L1 mm	∅ mm	
1716Q	215	100	6	5 017160010

1716R

round bit reamer

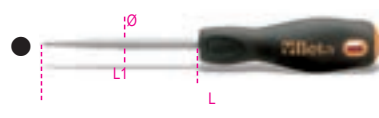

	L mm	L1 mm	∅ mm	
1716R	215	100	6	5 017160001

1716U

hook bit for general use



	L mm	L1 mm	∅ mm	
1716U	195	80	6	3 017160025

1717A

scrapers, two cutting edges



L mm	L1 mm	L2 mm		
150	70	260	2	017170015
200	75	310	2	017170020
250	100	360	2	017170025

1717B

scrapers, three cutting edges



L mm	L1 mm	L2 mm		
150	75	260	2	017170115
200	85	310	2	017170120
250	100	360	2	017170125

1717C

flat scrapers, varnished

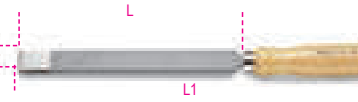

L mm	S mm	L1 mm		
150	18	270	2	017170215
200	20	320	2	017170220
250	25	370	2	017170225

1717D

flat scraper, front cut



L mm	S mm	L1 mm		
1717D 150	150	23 240	2	017170320

1718D...Q

rough square files, without handles

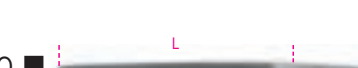

	L mm	L "		
1718D6/Q	150	6	5	017180121
1718D8/Q	200	8	5	017180131
1718D10/Q	250	10	5	017180141

1718A...Q

second-cut square files, without handles



	L mm	L "		
1718A6/Q	150	6	5	017180021
1718A8/Q	200	8	5	017180031
1718A10/Q	250	10	5	017180041

1718D...T

rough triangular files, without handles



	L mm	L "		
1718D6/T	150	6	5	017180123
1718D8/T	200	8	5	017180133
1718D10/T	250	10	5	017180143

1718A...T

second-cut triangular files, without handles



	L mm	L "		
1718A6/T	150	6	5	017180023
1718A8/T	200	8	5	017180033
1718A10/T	250	10	5	017180043

1718D...P

rough flat files, without handles



	L mm	L "		
1718D6/P	150	6	5	017180125
1718D8/P	200	8	5	017180135
1718D10/P	250	10	5	017180145

1718A...P

second-cut flat files, without handles



	L mm	L "		
1718A6/P	150	6	5	017180025
1718A8/P	200	8	5	017180035
1718A10/P	250	10	5	017180045

1718D...M

rough half-round files, without handles



	L mm	L "		
1718D6/M	150	6	5	017180127
1718D8/M	200	8	5	017180137
1718D10/M	250	10	5	017180147

1718A...M

rough half-round files, without handles



	L mm	L "		
1718A6/M	150	6	5	017180027
1718A8/M	200	8	5	017180037
1718A10/M	250	10	5	017180047

1718D...R

rough round files, without handles



	L mm	L "		
1718D6/R	150	6	5	017180129
1718D8/R	200	8	5	017180139
1718D10/R	250	10	5	017180149

1718A...R

second-cut round files, without handles



	L mm	L "		
1718A6/R	150	6	5	017180029
1718A8/R	200	8	5	017180039
1718A10/R	250	10	5	017180049

1718D...S5

set of 5 rough files, without handles



	L mm	L "		
1718D6/S5	150	6	1	017180130
1718D8/S5	200	8	1	017180140
1718D10/S5	250	10	1	017180150

1718A...S5

set of 5 second-cut files, without handles



	L mm	L "		
1718A6/S5	150	6	1	017180030
1718A8/S5	200	8	1	017180040
1718A10/S5	250	10	1	017180050

1719BMD...Q

rough square files, with handles



	L mm	L "		
1719BMD6/Q	150	6	5	017190191
1719BMD8/Q	200	8	5	017190221
1719BMD10/Q	250	10	5	017190241
1719BMD12/Q	300	12	3	017190325

1719BMA...Q

second-cut square files, with handles



	L mm	L "		
1719BMA6/Q	150	6	5	017190021
1719BMA8/Q	200	8	5	017190052
1719BMA10/Q	250	10	5	017190071
1719BMA12/Q	300	12	3	017190311

1719BMX...Q

smooth square files, with handles



	L mm	L "		
1719BMX6/Q	150	6	5	017190022
1719BMX8/Q	200	8	5	017190053
1719BMX10/Q	250	10	5	017190072

1719BMD...T

rough triangular files, with handles



	L mm	L "		
1719BMD6/T	150	6	5	017190193
1719BMD8/T	200	8	5	017190223
1719BMD10/T	250	10	5	017190243
1719BMD12/T	300	12	3	017190326

1719BMA...T

second-cut triangular files, with handles



	L mm	L "		
1719BMA6/T	150	6	5	017190023
1719BMA8/T	200	8	5	017190054
1719BMA10/T	250	10	5	017190073
1719BMA12/T	300	12	3	017190313

1719BMX...T

smooth triangular files, with handles



	L mm	L "		
1719BMX6/T	150	6	5	017190024
1719BMX8/T	200	8	5	017190055
1719BMX10/T	250	10	5	017190074

1719BMD...P

rough flat files, with handles



	L mm	L "		
1719BMD6/P	150	6	5	017190195
1719BMD8/P	200	8	5	017190225
1719BMD10/P	250	10	5	017190245
1719BMD12/P	300	12	3	017190327

1719BMA...P

second-cut flat files, with handles



	L mm	L "		
1719BMA6/P	150	6	5	017190025
1719BMA8/P	200	8	5	017190056
1719BMA10/P	250	10	5	017190075
1719BMA12/P	300	12	3	017190315

1719BMX...P

smooth flat files, with handles



	L mm	L "		
1719BMX6/P	150	6	5	017190026
1719BMX8/P	200	8	5	017190057
1719BMX10/P	250	10	5	017190076

1719BMD...M

rough half-round files, with handles



	L mm	L "		
1719BMD6/M	150	6	5	017190197
1719BMD8/M	200	8	5	017190227
1719BMD10/M	250	10	5	017190247
1719BMD12/M	300	12	3	017190328

1719BMA...M

second-cut half-round files, with handles



	L mm	L "		
1719BMA6/M	150	6	5	017190027
1719BMA8/M	200	8	5	017190058
1719BMA10/M	250	10	5	017190077
1719BMA12/M	300	12	3	017190317

1719BMX...M

smooth half-round files, with handles



	L mm	L "		
1719BMX6/M	150	6	5	017190028
1719BMX8/M	200	8	5	017190059
1719BMX10/M	250	10	5	017190078

1719BMD...R

rough round files, with handles



	L mm	L "		
1719BMD6/R	150	6	5	017190199
1719BMD8/R	200	8	5	017190229
1719BMD10/R	250	10	5	017190249
1719BMD12/R	300	12	3	017190329

1719BMA...R

second-cut round files, with handles



	L mm	L "		
1719BMA6/R	150	6	5	017190029
1719BMA8/R	200	8	5	017190060
1719BMA10/R	250	10	5	017190079
1719BMA12/R	300	12	3	017190319

1719BMX...R

smooth round files, with handles



	L mm	L "		
1719BMX6/R	150	6	5	017190031
1719BMX8/R	200	8	5	017190061
1719BMX10/R	250	10	5	017190081

1719BMD...S5

set of 5 rough files, with handles

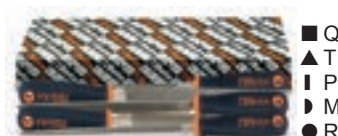

	L mm	L "		
1719BMD6/S5	150	6	1	017190200
1719BMD8/S5	200	8	1	017190230
1719BMD10/S5	250	10	1	017190250
1719BMD12/S5	300	12	1	017190363

1719BMA...S5

set of 5 second-cut files, with handles

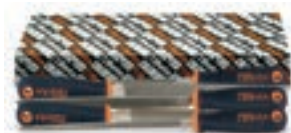

	L mm	L "		
1719BMA6/S5	150	6	1	017190030
1719BMA8/S5	200	8	1	017190070
1719BMA10/S5	250	10	1	017190080
1719BMA12/S5	300	12	1	017190361

1719BMX...S5

set of 5 smooth files, with handles

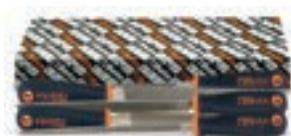

	L mm	L "		
1719BMX6/S5	150	6	1	017190032
1719BMX8/S5	200	8	1	017190069
1719BMX10/S5	250	10	1	017190082

1719BMB/P

universal cut flat files,
plastic handles

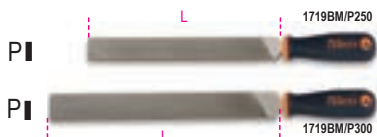

L mm	L "		
250	10	5	017190152
300	12	5	017190153

1719BMC

half-round and flat files,
plastic handles

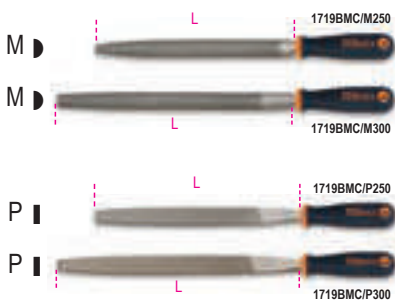

UNI 5569 - UNI 5568

	L mm	L "		
1719BMC/M 250	250	10	6	017190252
1719BMC/M 300	300	12	4	017190253
1719BMC/P 250	250	10	6	017190262
1719BMC/P 300	300	12	4	017190263

1719BM/RR

round rasp,
plastic handle



	L mm	L "		
1719BM/RR	200	8	5	017190351

1719BM/RL

flat rasp file,
plastic handle



	L mm	L "		
1719BM/RL	200	8	5	017190360

1719BMR

handles for files



	L mm	A mm		
1719BMR/0	95	25	10	017190950
1719BMR/0B	110	29	10	017190955
1719BMR/1	110	29	10	017190951
1719BMR/1B	110	29	10	017190953
1719BMR/2	123	31	10	017190952
1719BMR/2B	123	31	10	017190954

	mm		
1719BMR/0	100/150	4/6	▲▶
1719BMR/0B	100/150	4/6	●●
1719BMR/1	150/200	6/8	▲▶
1719BMR/1B	150/200	6/8	●●
1719BMR/2	250/300	10/12	▲▶
1719BMR/2B	250/300	10/12	●●

1720/...

needle files

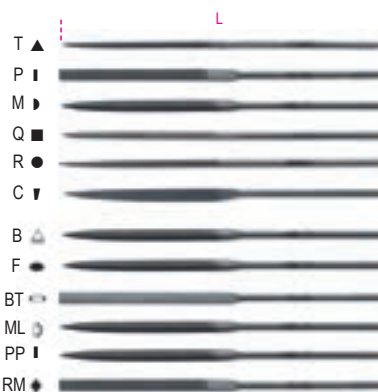

UNI 5569 UNI 5670

	L mm		
1720T	160	5	017200004
1720P	160	5	017200006
1720M	160	5	017200008
1720Q	160	5	017200009
1720R	160	5	017200010
1720C	160	5	017200012
1720B	160	5	017200005
1720ML	160	5	017200007
1720BT	160	5	017200011
1720F	160	5	017200013
1720PP	160	5	017200014
1720RM	160	5	017200015



1720/S3		1	017200000

1720/B

set of 6 needle files in plastic wallet



1720/B6	1	017200002
1720/B12	1	017200003

1720D/...

diamond needle files



	L mm		
1720D/T	160	2	017200104
1720D/P	160	2	017200106
1720D/M	160	2	017200108
1720D/Q	160	2	017200109
1720D/R	160	2	017200110
1720D/C	160	2	017200112



1720D/B6	1	017200120
----------	---	-----------

1721/B6

set of 6 files for ignition contacts
in plastic wallet



1721/B6	1	017210010
---------	---	-----------

1723

spring puller



	L mm		
1723	210	5	017230001

1725

hacksaw frame



	L mm	L1 mm		
1725	420	300	4	017250001

1725CR

mini hacksaw frame

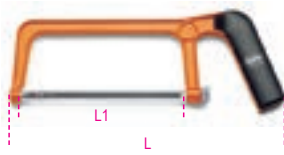

1725CR	L mm 250	L1 mm 150	5	017250010
--------	----------------	-----------------	---	-----------

1726

hacksaw frame, blade attachment system in the handle

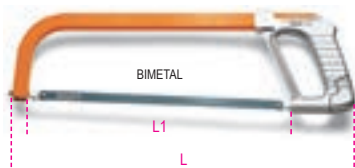

1726	L mm 440	L1 mm 300	4	017260001
------	----------------	-----------------	---	-----------

1726BM

Hacksaw frame with quick release blade attachment system

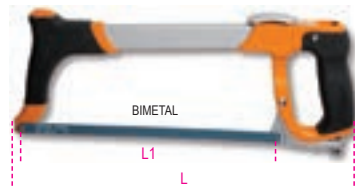

1726BM	L mm 400	L1 mm 300	1	017260050
--------	----------------	-----------------	---	-----------

1727

hacksaw frame, heavy series

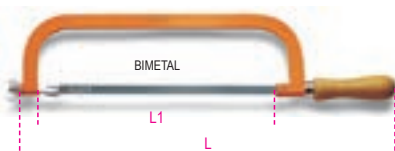

1727	L mm 515	L1 mm 300	4	017270001
------	----------------	-----------------	---	-----------

1727BM

hacksaw frame, one hand grip



1727BM	L mm 315	L1 mm 300	5	017270020
--------	----------------	-----------------	---	-----------

1728...

blades for hacksaw frames



1728LA	100	017280001
1725CR		
1725MQ		
1728BM	100	017280010
1725-1726		
1727-1727M		
1728CO	50	017280030
1725-1726		
1727-1727M		

1729

fixed frame hacksaw

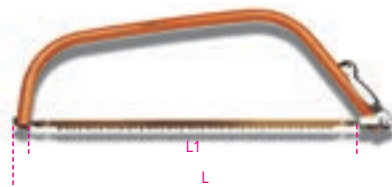

1729	L mm 710	L1 mm 610	5	017290001
------	----------------	-----------------	---	-----------

1729LR

spare blade for item 1729

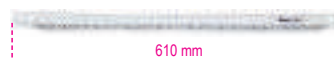

1729LR	10	017290010
--------	----	-----------

1729CG

plasterboard saw



1729CG	L mm 310	L1 mm 160	2	017290200
--------	----------------	-----------------	---	-----------

1729DM 450

wood rip saw

medium tothing, 12 teeth/inch



1729DM 450	L mm 450	L1 mm 400	4	017290450
------------	----------------	-----------------	---	-----------

1736A

file brush



1736A	L mm 240	10	017360010
-------	----------------	----	-----------

1737

brush, brass wires



1737	L mm 145	10	017370001
------	----------------	----	-----------

1737NX

brake shoe cleaning brush
plastic handle steel wires



1737NX	L mm 270	5	017370010
--------	----------------	---	-----------

1737AC

steel wire brush



1737AC	L mm 275	5	017370020
--------	----------------	---	-----------

1737B

pairs of battery lug and post cleaner steel brushes



1737B	1	017370050
-------	---	-----------

1738

bristle brush



1738	L mm 210	H mm 30	10	017380001
------	----------------	---------------	----	-----------

1739B

lazy tongs riveter, supplied with 5 interchangeable nozzles



max 830 mm

Ø mm	3,2	4	4,8	5	6	6,4
Aluminium	•	•	•	•	•	•
Stainless steel	•	•	•	•		

1739B 1 017390151

1740A

heavy duty riveting pliers supplied with 5 interchangeable nozzles



525 mm

Ø mm	3,2	4	4,8	5	6	6,4
aluminium	•	•	•	•	•	•
stainless steel	•	•	•	•		

1740A 1 017400101

1740B

compact heavy-duty riveting pliers, supplied with 5 interchangeable nozzles



L

Ø mm	2,4	3	3,2	3,2	4,8
aluminium	•	•	•	•	•
steel	•	•	•	•	•
stainless steel	•	•	•	•	•

1740B 280 1 017400280

Ø mm	3,2	4	4,8	5	6	6,4
aluminium	•	•	•	•	•	•
steel	•	•	•	•	•	•
stainless steel	•	•	•	•		

1740B 330 1 017400330

1741B

riveting pliers supplied with 4 interchangeable nozzles



250 mm

Ø mm	2,4	3,2	4	4,8	5
Aluminium	•	•	•	•	•
Steel	•	•	•	•	•
Stainless steel	•	•	•		

1741B 1 017410000

1741B/C5

riveting pliers item 1741B with assortment of 700 aluminium rivets



1741B/C5 1 017410025

	Ø mm	L mm	n.
1741RV2,9K	3,0	6	200
1741RV3,2K	3,2	8	200
1741RV3,8K	4,0	10	100
1741RV4K	4,0	12	100
1741RV4,8K	4,8	12	100

415x155x60 mm - 3,1 Kg

1741BP

riveting pliers supplied with 4 interchangeable nozzles



260 mm

Ø mm	2,4	3,2	4	4,8	5
Aluminium	•	•	•	•	•
Steel	•	•	•	•	•
Stainless steel	•	•	•		

1741BP 1 017410350

1741U

ultra compact riveting pliers with adjustable force with 4 interchangeable nozzles 3 legs: enhanced rivet hold



200 mm

Ø mm	2,4	3	3,2	4	4,8
Aluminium	•	•	•	•	•
Steel	•	•	•	•	•
Stainless steel	•	•	•	•	•

1741U 1 017410450

1741RV...K

aluminium rivets



1741RV 2,9K	1 017410191
ØxL = 3x6 mm	
1741RV 3,2K	1 017410192
ØxL = 3,2x8 mm	
1741RV 3,8K	1 017410193
ØxL = 4x10 mm	
1741RV 4K	1 017410194
ØxL = 4x12 mm	
1741RV 4,8K	1 017410195
ØxL = 4,8x12 mm	

1742

riveting pliers for threaded rivets, with 4 interchangeable mandrels



250 mm

1742 1 017420001

M	Ø mm	L mm
3	5	11
4	6	11
5	7	13
6	9	17



1742KR

spare mandrels for item 1742



M3	1	017420043
M4	1	017420044
M5	1	017420045
M6	1	017420046

1742R-AL/M...

aluminium threaded rivets for items 1742-1742A-1946KF



1742R-AL M3	1	017420023
ØxL = 5x10 mm M = 3		
1742R-AL M4	1	017420024
ØxL = 6x12 mm M = 4		
1742R-AL M5	1	017420025
ØxL = 7x13 mm M = 5		
1742R-AL M6	1	017420026
ØxL = 9x15 mm M = 6		

1742R-A/M...

steel threaded rivets for items 1742-1742A-1946KF



1742R-A M3	1	017420013
ØxL = 5x11 mm M = 3		
1742R-A M4	1	017420014
ØxL = 6x11 mm M = 4		
1742R-A M5	1	017420015
ØxL = 7x13 mm M = 5		
1742R-A M6	1	017420016
ØxL = 9x17 mm M = 6		
• 1742R-A M8	1	017420018
ØxL = 11x17 mm M = 8		
• 1742R-A M10	1	017420020
ØxL = 13x24 mm M = 10		

1742/C4

riveting pliers item 1742 with assortment of 400 threaded steel insets



1742/C4 1 017420005

	M	Ø mm	n.
1742R-A/M3	3	5	100
1742R-A/M4	4	6	100
1742R-A/M5	5	7	100
1742R-A/M6	6	9	100

415x155x60 mm - 2,9 kg

1742A

heavy duty riveting pliers for threaded insets, with 4 interchangeable mandrels



1742A 1 017420100

M	Ø mm	L mm
5	7	13
6	9	17
8	11	17
10	13	24

1742A/KR

spare pins for item 1742A



1742A/KR M5	M5	1	017420143
1742A/KR M6	M6	1	017420144
1742A/KR M8	M8	1	017420145
1742A/KR M10	M10	1	017420146

1742A/C

riveting pliers item 1742A with assortment of 60 threaded steel insets



1742A/C 1 017420105

	M	Ø mm	n.
1742R-A/M5	5	7	20
1742R-A/M6	6	9	20
1742R-A/M8	8	11	10
1742R-A/M10	10	13	10

536x310x80 mm - 2,1 kg

1743

fitting tool for nylon ties

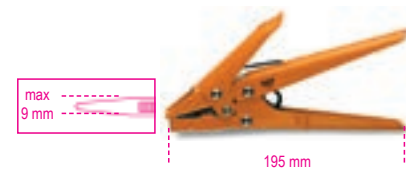

1743 1 017430001

1743T

cable tie cutting tool

• Also suitable for cutting small cables (3x1.5mm²; 1x17mm²)



1743T 1 017430100

1749

bonding gun varnished metal sheet



1749 2 017490001



1749A

bonding gun, professional model
aluminium tube



1749A	L min mm		
	360	1	017490010

1749A/RB

spare spouts for item 1749A

1749A/RB			
	2	017490051	

1749A/RT

front screw plugs for item 1749A

1749A/RT			
	1	017490052	

1749AC

high thrust gun for chemical binders



1749AC	L min mm		
	360	1	017490005

1750

lever operated grease guns



1 g, 550 bar Max

cc	L mm		
500	380	1	017500500
750	450	1	017500750

1750R/1 - 1750R/2

spare flexible hose made from nylon



1750R/1	L mm		
	310	2	017500030
1750R/2	410	2	017500040

1750RC

curved rigid hose



1750RC	L mm	M mm		
	150	10x1	2	017500050

1750RT

4-jaw grease fitting "Hydraulic" type



1750RT	M mm		
	10x1	5	017500110

1750RP/1 - 1750RP/2

heads for flat nozzles

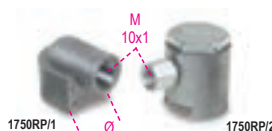

	Ø mm	M mm		
1750RP/1	16	10x1	2	017500115
1750RP/2	22	10x1	2	017500120

1750CG

grease cartridges for item 1750



cc			
400	18	017500140	
600	18	017500160	

1750KG10

lever-operated grease gun, 10 kg,
with high-pressure hose, 2 m

complete with swivel fitting, to avoid choking hose
die-cast aluminium pump body with check valve

3 different pressure levels available:

- 4 g at 275 bar
- 7 g at 206 bar
- 9 g at 137 bar



1750KG10			
	1	017500100	

1750TA

high-pressure, self-locking 6-pin grease nozzle

Once positioned, it remains on axis and connected to nipple;
it does not have to be held like common nozzles
Easy to disconnect, even when with pressurized nozzle
Thread M10x1: suitable for all types of grease guns: electric,
pneumatic, manual etc.
Deformation-free up to 550 bar



1750TA			
	1	017500111	

1750M

mini grease gun

- With micro nozzle
- Particularly suitable for pneumatic tools



1750M	cc	D mm	L mm		
	100	43	145	1	017500025

1751

metal pressure oil cans flexible spout



cc	D mm	L mm		
200	62	140	4	017510002
300	75	140	4	017510003
500	85	140	4	017510005
750	100	140	2	017510007
1000	100	140	2	017510011

1751R

spare spout for item 1751



200÷1000			
	5	017510010	

1752

plastic pressure cans rigid spouts



cc	D mm	L mm		
200	67	140	4	017520002
300	77	140	4	017520003
500	95	140	4	017520005
700	95	140	2	017520007

1752R

spare spout for item 1752



cc			
200=700			5 017520020

1753

plastic pressure oil cans flexible spouts



cc	D mm	L mm		
200	65	190	4	017530002
300	80	190	4	017530003
500	95	190	4	017530005
700	95	190	2	017530007

1753R

spare spout for item 1753



cc			
200=700			5 017530020

1754

plastic pressure oil cans flexible plastic spouts



cc	D mm	L mm		
150	60	130	5	017540015
250	65	130	5	017540025

1755

plastic oil bottles retractable spouts



cc	L mm	A mm		
30	160	30	5	017550003
80	170	47	5	017550008
150	230	58	5	017550015

1756

pen oiler



cc	L mm		
5	140	2	017560001

1756B

pen oiler



cc	L mm		
500	280	2	017560220

1756C

suction gun, 200 ml, made of polypropylene

- Also suitable for braking system fluid
- Double EPDM gasket
- Operating temperature: +0 - +50 °C
- NOT suitable for fuel



1756C	1	017560502
-------	---	-----------

1756D

suction gun, 1500 ml, made of polypropylene

- Double NBR gasket
- Operating temperature: +0 - +50 °C
- NOT suitable for fuel

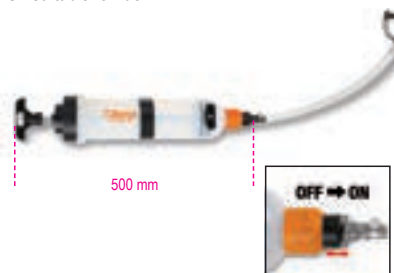

1756D	1	017560515
-------	---	-----------

1756G

diesel oil gun capacity: 1.5 l

- Can be used to:
- fill diesel oil filters
 - fill Cerina tank



- Kit contents:
- 2 pipes with female quick couplings for connecting diesel oil pipes
 - 2 male quick couplings, made of metal
 - 1 cone-shaped adapter for rubber pipes

1756G	1	017560615
-------	---	-----------

1756C-20R

O-rings (pair) for suction guns 1756C

1756C-20R	1	017560503
-----------	---	-----------

1756D-20R

O-rings (pair) for suction guns 1756D

1756D-20R	1	017560516
-----------	---	-----------

Beta

1757
battery fillers



cc	D mm		
250	60	4	017570002
500	75	4	017570004
1000	90	2	017570006

1757A
battery filler



cc			
2000		1	017570020

1758
self-adapting funnel

particularly useful for cars
with no depth in
inlet plugs



1758		1	017580020

1758A
non-return funnel
with quick coupling, Ø 38 mm
For Volkswagen group cars



1758A		1	017580010



1758B

non-return funnel
with quick couplings
Particularly suitable
for VAG cars



1758B		1	017580030

1758LG

formable, rubber-covered aluminium foil,
for canalizing liquids



L mm	H mm		
365	168	1	017580006

1758M
funnel



	L mm		
1758M	350	1	017580000

1758R
liquid containers

Convenient, removable, flexible spout



	lt		
1758R 3	3	1	017580203
1758R 5	5	1	017580205

1758VT

cylinder head testing kit

Quickly indicates whether expansion tank contains any
carbon dioxide.



1758VT		1	017580100

290x190x50 mm - 1 kg

1758VT/L

contrast liquid for testing cylinder heads



1758VT/L		1	017580101



1759

optical analyzer for coolant, battery, windscreen and AdBlue® fluids
Supplied in a hard case

Automatic temperature compensation
Battery acid: measurement range:
1.1±1.3 kg/l
Propylene coolant: -25 °C ÷ +50 °C
Ethylene coolant: -25 °C ÷ -50 °C
Windscreen fluid: -25 °C ÷ -40 °C
AdBlue: Urea percent measurement: 30% ÷ 45%



1759 1 017590251

1759A

antifreeze densimeter, glass body



1759A 340 mm 1 017590001

1759B

acid densimeter, glass body



1759B 280 mm 1 017590005

1759HD/3

cooling system seal testing and circuit filling tools

• Make it possible to check circuit (pipes, joints, pumps, radiators) for leaks under pressure and quickly fill circuit, avoiding air bubble formation



1759HD/3 1 017590063

600x500x140 mm - 6,5 kg

1759HD/RR

cooling system filling tool



1759HD/RR 1 017590064

450x310x110 mm - 2,2 kg

1759HD/TRUCK

truck cooling system testing and sealing tool



1759HD/TRUCK 1 017590065

440x330x100 mm - 3 kg

1759TT

Kit of 4 pairs of turbo circuit testing caps, for use with tyre inflators



1759TT 1 017590300

400x160x100 mm - 1,8 kg

1760DGT

digital automotive multimeter



TECHNICAL DATA
RPM (tachometer):
For 2 and 4 cylinder engines
RPM4 600 - 4000 RPM
RPM4 600 - 12000 RPM (x10 RPM)
RPM2/DIS 300 - 4000 RPM
RPM2/DIS 300 - 6000 RPM (x10 RPM)
Dwell angle: 4-8 CYL
DC voltage: 400mV-4/40/400/1000V
AC voltage: 4/40/400/700V
DC current: 40/400mA-4/20A
AC current: 40/400mA-4/20A
Resistance: 400Ω-4/40/400kΩ-4/40MΩ
Capacity: 40/400nF-4/40/100μF
Frequency: 5/50/500Hz-50/500-10MHz
Duty cycle: 0.1 % - 99.9%
Pulse amplitude: 1 - 10ms
Diode test: Test current 0.3mA
Continuity: <150Ω - Test current <0.3mA
Display: High-contrast, backlit 4-digit LCD
Overvoltage: Category II 1000V
Auto power off: 30 minutes
Power supply: 1.9V battery (included)
Inductive clamp (included)
2 tips (included)
Soft cloth case (included)
Operating manual

1760DGT 1 017600005

1760B

digital multimeter



CE



SPECIFICATIONS

DC voltage: 200 mV-2/20/200/1000V
 AC voltage: 2-20/200/700V
 DC current: 2/20/200 mA-20 A
 AC current: 2/200 mA- 20 A
 Resistance: 200Ω - 2/20/200 kΩ - 2/20 MΩ
 Capacity: 2/20/200 nF - 2/200 μF
 Temperature: -20° + 1000°C/ -4 °F ~ +2000°F
 Frequency: 20kHz
 Power supply: 1 9V battery (included)

1760B

1 017600012

1760/OHM

Multimeter/megohmmeter for high voltage insulation testing.
 TRUE RMS indicator



CE

CAT. IV
 600V
 CAT. III
 1000V



Measuring range	Base accuracy
AC/DC voltage: 50mV - 1000V	±0.06% - ±0.1% rdg
AC/DC current: 0.01μA - 10A	±0.5% - ±1% rdg
Resistance: 0.01Ω - 50MΩ	±0.2% - ±2% rdg
Meg OHM: 0.01 - 5000MΩ	±4% rdg. max current 1mA
Capacity: 5nF - 10mF	±1.5% - ±3% rdg
Frequency: 50Hz - 100 MHz	±0.02% - ±0.1% rdg
Temperature: -50 °C - +1350 °C	±0.5% rdg
Diode test: 3V dc	
Continuity test: <30 Ω	

1760/OHM

1 017600025

1760/RMS

industrial digital multimeter
 accurate and sturdy, in a 6-mm co-moulded shell, with antislip, shockproof outer rubber part



CE

Measuring range	Base accuracy
AC/DC voltage	110mV - 600V ±0.8% - ±2% rdg
AC/DC current	110μA - 10A ±1.5% - ±2% rdg
Resistance	110Ω - 40MΩ ±1.2% - ±2.5% rdg
Capacity	11nF - 40mF ±5% - ±10% rdg (up to 11mF)
Frequency	1100Hz - 110 MHz ±1.2% - ±1.5% rdg
Temperature	-32°C - +1000°C ±3% - ±5% rdg
Diode test, 3V DC ±10%	rdg
Continuity test	<30 Ω -

1760/RMS

1 017600020

1760PA/80

AC/DC amperometric clamp, 80A

Designed to measure low current leakage or absorption values on vehicles



CE

- Range: 1mA-80A AC/DC
- Torch function with white LED
- Backlit LCD display
- Zero setting function
- Hold function
- Auto power off
- Power supply: 2 1.5V AAA-type batteries

1760PA/80

1 017600002

1760PA/AC

amperometric clamp and digital multi-meter

A: AC
 V: AC/DC



CE



SPECIFICATIONS

DC voltage 400 mV - 4/40/400/600 V
 AC voltage 400 mV - 4/40/400/600 V
 AC current 40/400/1000 A
 Resistance 400Ω - 4/40/400 kΩ - 4/40 MΩ
 Frequency 5/50/500 Hz - 5/50/500 kHz - 5/10 MHz
 Capacity 40/400 nF - 4/40/100 μF
 Temperature - 20 °C + 1000 °C / -4 °F + 1832 °F
 Power supply: 1 9V battery (included)

1760PA/AC

L
mm
190

1 017600050

1760PA/AC-DC

amperometric clamp and digital multimeter

A: AC/DC
 V: AC/DC



CE



A: AC/DC
 V: AC/DC

SPECIFICATIONS

DC voltage: 0.1mV + 600V
 AC voltage: 0.1mV + 600V
 AC current: 0.01A + 1000A
 DC current: 0.01A + 1000A
 Resistance: 0.1Ω + 40MΩ
 Capacity: 0.001nF + 40 μF
 Frequency: 0.001kHz + 4kHz
 Temperature: -40°C + 1000 °C
 -40°F + 1832°F

1760PA/AC-DC

1 017600000

1760DGT-R3

spare leads for digital multimeters and amperometric clamps



1760DGT-R3

1 017600603

1760/RSE

signal detector

Allows power supply of parts to be tested, including common rail electro-injectors, petrol/LPG electro-injectors, piezoelectric injectors, flow regulating solenoid valves, EGR solenoid valves and coils



CE

Performing diagnosis of individual parts of electric system only requires probe to be brought near part being tested. In systems with electromechanical/electronic parts controlled by a control unit, this tool makes it possible to check whether:

- control unit is being supplied with power and is performing its control function
- cables connecting control unit to part is efficient
- part being tested has not being disconnected
- part has not short-circuited
- part is operating electronically

1760/RSE

1 017600170

1760/TC2

combination contact/non-contact digital tachometer



CE

TECHNICAL DATA

- For measuring:
 - non-contact rotational speed (rpm)
 - contact rotational (rpm)
 - and linear surface speed (m/min or ft/min).
- 5-digit LCD display.
- Scale:
 - non-contact speed 2.5÷99,999 rpm
 - contact speed 0.5÷19,999 rpm
 - linear surface speed 0.05÷1,999.9 m/min.
- Frequency: 0.8 sec.
- Power supply: 4 1.5V batteries, AA size, or 6V power supply unit (not included).
- Supplied with the following:
 - adaptor for contact tip measurement;
 - male (contact) rubber tip (2 pcs.);
 - female (contact) rubber tip (1 pcs.);
 - linear measurement tape (1 pcs.);
 - reflecting tapes;
 - instruction manual;
 - plastic case.

1760/TC2 L H
mm mm
230 74 1 017600161

1760R/TC2

set of reflecting tapes for item 1760/TC2



1760R/TC2

1 017600561

1760K

non-contact AC voltage detector with LED mini-torch

Testing range: 200-1000Vac 50/60Hz
CAT III-1000V
Requires 2 AAA batteries (included)



CE
CAT III-
1000V

1760K

1 017600140

1760PT

combination voltage and continuity tester, 12-690V AC/DC

Functions:

- continuity
- phase rotation
- mains testing
- LED torch

CE



IP64
CATIV
- 600V ;
CATIII -
1000V

1760PT

1 017600150

1760/IR500

digital infrared thermometer with dual laser aiming system



CE

TECHNICAL DATA

Temperature range: -50 ÷ 500 °C (-22 ÷ +932 °F)
Display resolution: 0.1 °C (0.1 °F)
Emissivity: 0.1 ÷ 1 adjustable
Accuracy: -50 °C ÷ +20 °C (+/- 3 °C); 20 ÷ 500 °C (+/-2% or 2 °C)
Optical resolution (D:S): 12:1
Auto power off: ca. 10 seconds
Operating temperature: 0 °C ÷ 50 °C
Storage temperature: -20 °C ÷ 60 °C
Power supply: 1 9V battery

1760/IR500

1 017600350

Beta

Beta

1760/IR1000

digital infrared thermometer with dual laser aiming system

CE



TECHNICAL DATA

Temperature range: $-50\text{ }^{\circ}\text{C} + ^{\circ}\text{A}1000\text{ }^{\circ}\text{C}$ ($-58\text{ }^{\circ}\text{F} + ^{\circ}\text{A}1832\text{ }^{\circ}\text{F}$)
Display resolution: $0.1\text{ }^{\circ}\text{C}$ ($0.1\text{ }^{\circ}\text{F}$)
Emissivity: 0.1 ± 1 adjustable
Accuracy: $-50\text{ }^{\circ}\text{C} + 20\text{ }^{\circ}\text{C}$ ($\pm 3.5\text{ }^{\circ}\text{C}$); $20\text{ }^{\circ}\text{C} + 300\text{ }^{\circ}\text{C}$ ($\pm 1\%$ or $1\text{ }^{\circ}\text{C}$); $300\text{ }^{\circ}\text{C} + 1000\text{ }^{\circ}\text{C}$ ($\pm 1.5\%$)
Optical resolution (D:S): 20:1
Operating temperature: $0\text{ }^{\circ}\text{C} + 50\text{ }^{\circ}\text{C}$
Storage temperature: $-10\text{ }^{\circ}\text{C} + 60\text{ }^{\circ}\text{C}$
Power supply: 2 1.5V (AAA type batteries)

1760/IR1000 1 017600400

1760/IR1600

digital infrared thermometer with laser aiming system

CE



TECHNICAL DATA

Range: da $-50\text{ }^{\circ}\text{C}$ to $+1600\text{ }^{\circ}\text{C}$ / $-58\text{ }^{\circ}\text{F}$ to $+2912\text{ }^{\circ}\text{F}$
Scale selection: $^{\circ}\text{C}/^{\circ}\text{F}$
Accuracy: $\pm 1.5\%$ or $\pm 2\text{ }^{\circ}\text{C}$ to $20\text{ }^{\circ}\text{C}$
Laser power: $< 1\text{mW}$
Response: 1sec
Emissivity: 0.10-1.0 adjustable
Distance ratio: (D:S) 50:1
Operating temperature: $0\text{ }^{\circ}\text{C} + 50\text{ }^{\circ}\text{C}$ / $32\text{ }^{\circ}\text{F} + 122\text{ }^{\circ}\text{F}$
Operating humidity: 10% to 90% RH
Backlit LCD display
Data storage function
Auto power off
Power supply: 1 9V battery (included)
Hard case with aluminium tripod
Operating manual

1760/IR1600 200 mm 115 mm 1 017600461

1761

wire twisting pliers with automatic return



L mm 255 1 017610101

1761RS/1

reversible wire twisting pliers with automatic return



L mm 220 1 017610130

1762

revolving punch pliers



\emptyset mm 2-2,5-3 3,5-4-4,5 L mm 210 2 017620001

1763

Car upholstery clip pliers



1763 1 017630001

1763G/S500

500 car upholstery clips



1763G/S500 1 017630105

1765/C24

cases with 24 tools for pulling out car radios



1765/C24 1 017650001

1766

double suction lifter

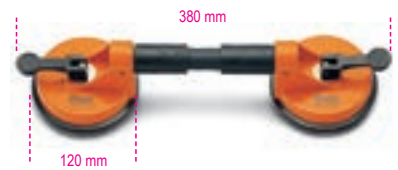

max kg 50 2 017660001

1766A

single suction cup



max kg 30 2 017660005

1766/8

assortment of 8 tools for car glass windows

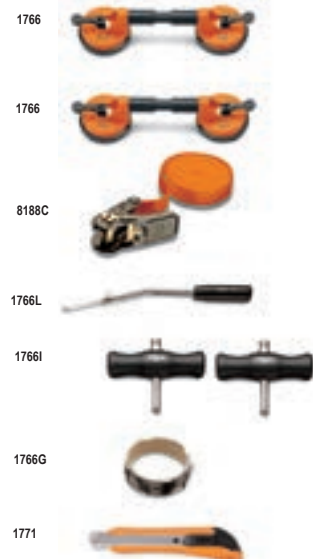

1766/8 1 017660100

1766ER

window trim removal tool
with handle

Allows window trims to be easily removed,
with no risk of damage



1766ER 1 017660501

1766L

lever for glass windows



1766L 1 017660015

1766LI

lever for inserting car glass window cutting
cable
sharp edges for cutting bonds



1766LI 1 017660016

1766I

handle for steel cable item 1766G

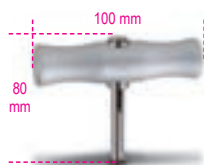

1766I 2 017660020

1766G

steel cable for car windows

Square section



50 m 1 017660025

1766T

steel cable for glass windows

triangular section



50 m 1 017660026

1767A

telescopic rod

- designed to support bonnets and tailgates with decompressed pistons.
- can be used to keep pedals from moving.



L mm 640 ÷ 1090 1 017670000

1767PMC

magnetic tool holder, round



1767PMC 1 017670020

1767PMR

magnetic tool holder, rectangular



1767PMR 1 017670010

1770

extra flat utility knife,
9 mm snap-off blade

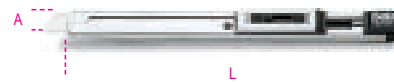

1770 L mm 140 A mm 9 10 017700001

1770A

utility knife 9 mm with automatic blade locking
mechanism,
3 blades



1770A L mm 135 A mm 9 10 017700025

1770RL

9 mm snap-off blades 10 pieces
for utility knives 1770, 1770BM and 1770A



1770RL 5 017700010

1770BM

utility knife, 9 mm, 6 blades



1770BM L mm 140 A mm 9 10 017700050

1771

utility knife, 18 mm,
supplied with 3 blades



1771 10 017710000

1771BM

utility knife, 18 mm,
6 spare blades



1771BM L mm 170 A mm 18 10 017710050

1771HD

utility knife, 18 mm,
supplied with 6 blades

- automatic blade change
- screw blade locking system



1771HD	L mm	A mm	5 017710100
	190	18	

1771RL

18 mm snap-off spare blades (10 pieces)
for utility knives 1771, 1771BM, 1771HD



1771RL	5 017710010
--------	-------------

1772M

safety utility knife with retractable blade,
supplied with 3 blades

- blade retracts through an automatic spring mechanism
- die-cast alloy body
- staple remover built into handle



1772M	L mm	A mm	5 017720040
	170	18	

1772R

utility knife with retractable trapezoidal blade,
supplied with 5 blades



1772R	L mm	A mm	5 017720006
	125	18	

1772H

safety utility knife with retractable blade,
supplied with 2 blades



1772H	L mm	A mm	5 017720029
	170	18	

1772RL/2

10 long trapezoidal spare blades, in box,
for utility knives, 1772H, 1772M, 1772R,
1774, 1777BMT, 1777T

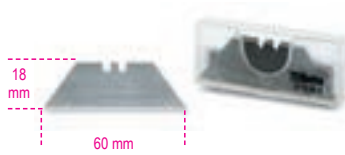

1772RL/2	5 017720017
----------	-------------

1773A

utility knife, 25 mm



1773A	L mm	A mm	10 017730000
	180	25	

1773RL

25 mm blades (10 pieces)
for utility knife 1773A



1773RL	5 017730015
--------	-------------

1774

multi-function scraper with blade guard



1774	L mm	L1 mm	5 017740001
	165	60	

1774A

multifunction scraper,
bi-material handle



1774A	L mm	A mm	1 017740011
	300	40	

1774A/RL

10 blades for multifunction scraper item 1774A

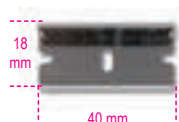

1774A/RL	1 017740511
----------	-------------

1777BM

foldaway knife with wire stripping notch,
stainless steel blade



1777BM	L mm	L1 mm	A mm	5 017770100
	190	80	16	

1777T

foldaway knife with trapezoidal stainless steel
blade,
5 spare blades



1777T	L mm	A mm	L1 mm	5 017770030
	160	19	65	

1777BMT

foldaway knife with trapezoidal blade
4 adjustable blade depths
4; 9.5; 15.5; 21.5 mm
supplied with 3 blades



1777BMT	L mm	L1 mm	A mm	5 017770050
	170	80	19	

1778CM

camouflage foldaway knife,
hardened steel blade,
in case



1778CM	L mm	A mm	L1 mm	5 017780099
	195	24	80	

1778D

foldaway knife,
stainless steel blade and handle,
in case



	L mm	A mm	L1 mm		
1778D	180	22	78	5	017780060

1778SCL

foldaway knife with soft carbon look finish,
hardened steel blade,
in case



	L mm	A mm	L1 mm		
1778SCL	180	22	78	5	017780089

1778SOS

car service knife
with window breaking hammer
and seat belt cutter features
in case



	L mm	A mm	L1 mm		
1778SOS	205	25	85	5	017780080

1778U

foldaway knife,
hardened steel blade
• in case



	L mm	A mm	L1 mm		
1778U	195	24	80	5	017780070

1778V18

foldaway knife,
aluminium handle
• in case



	L mm	A mm	L1 mm		
1778V18	195	25	85	5	017780018

1778W

foldaway knife,
stainless steel blade,
handle with wooden inserts,
in case



	L mm	A mm	L1 mm		
1778W	180	22	78	5	017780025

1778X

knives for nautical maintenance, stainless
steel blades, aluminium handles
in case



	L mm	L1 mm	A mm		
1778X	185	85	25	2	017780050

1781

slim, long blade scissors



	L mm				
1781	132	2	017810001		

1783

light duty scissors



	L mm				
1783	215	5	017830021		
	240	5	017830024		

1784

heavy duty scissors



	L mm				
1784	175	2	017840017		
	200	2	017840020		
	250	2	017840025		
	300	2	017840030		

1800/100

lifting airbags (max. lifting force: 100 kg)

- lifting/levelling
- locking doors



	A mm	B mm	S mm		
1800/100	160	150	2÷55	3	018000000

1808

dual rating soldering iron with steel tips
1824R8



	W	V			
1808	20/130	230	1	018080001	

1812 150

instant heat soldering iron

CE



230V
L=1,25 m Euro

W V
150 230
1 018120015

1814M

soldering irons
with steel tips

CE



L=1,2 m
230V
Schuko

W V
25 230
30 230
40 230
1 018140225
1 018140230
1 018140240

1820

soldering irons

CE



L=1,25 m
230V
Shuko

1820 30
30W
L = 210mm
1 018200003
1820 60
60W
L = 220mm
1 018200006
1820 80
80W
L = 260mm
1 018200008

1822

high-performance soldering irons

CE



230V
Shuko
L=1,25 m

1822 120
120W
LxA = 250x125 mm
1 018220012
1822 180
180W
LxA = 250x125mm
1 018220018
1822 320
320W
LxA = 250x140mm
1 018220032

1823 60

digital soldering station
supplied with soldering iron

- Temperature range: 160 °C ÷ 480 °C with ±1% accuracy.
- Memory mode designed to save the temperature selected when switching off the station.
- 3 quick selection keys (200-300-400 °C).

CE



W V
60
1 018230066

1823R/60

spare soldering iron for item 1823 60

CE



60W 24V
1 018230066

1824R

spare tips for soldering irons



1824R 08
1808
1 018240100
1824R 12
1812/150
1 018240301
1824R 14-M25
1814M/25
1 018240152
1824R 14-M30
1814M/30
1 018240153
1824R 14-M40
1814M/40
1 018240154
1824R 20
1820/30
1 018240302
1824R 60
1820/60
1 018240303
1824R 80
1820/80
1 018240304
1824R 120-180
1822/120 -/180
1 018240305
1824R 320
1822/320
1 018240307
1824R ST-60
1823-60
1 018240308

1825B

soldering tin wire with antioxidant

- 1 mm²; 250 g
- Sn 99.3%; Cu 0.7%



1825B
1 018250251

1827

gas soldering iron, adjustable

CE



240 mm

1827
1 018270001

1827PC

spare conical tips for item 1827



1827PC 1,6
1827PC 3,2
1 018270501
1 018270502

1827PCL

spare knife tips for item 1827



1827PCL 2,4
1 018270503

1827PFL

spare naked flame tips for item 1827



1827PFL
1 018270504

1827/K

gas soldering iron with 7 accessories
in case with soft polyethylene
foam base

CE



- Power: 30 watts to 125 watts
- Tip temperature can be adjusted between 250 °C and 500 °C
- Gas flow regulator
- Warm-up time: 15 seconds
- Tank contains gas for 120 minutes' non-stop operation
- Clear tank for monitoring gas level
- Can be refilled with butane gas

1827/K
1 018270100

1827F

butane gas soldering iron

35 g tank

- three interchangeable nozzles: 550 °C; 1000 °C; 1300 °C
- supplied with a stand in hard case



1827F

1 018270200

1830T

dissoldering pipe with antistatic plastic (PTFE) nozzle



L
mm
190

5 018300021

1834L/USB

rechargeable high-brightness LED torch,
made of sturdy anodized aluminium,
up to 450 lumens
USB recharged

flat battery indicator (appearing when battery charge is down to 20%)
battery life: 4h



IPX6

L
mm
220

1 018340075

1834RB-L/USB

spare battery for item 1834L/USB

1834RB-L/USB

1 018340975

1834PS

high-brightness LED torch,
made of sturdy, anodized aluminium,
up to 300 lumens

- Batteries (not included): 2xAAA (life 9/29 h)
- Lumens: 300>100>OFF
- IPX6



L
mm
150

1 018340310

1834PM

high-brightness LED torch,
made of sturdy, anodized aluminium,
up to 350 lumens

- Batteries (not included) :
- 1xAAA (life 11/33 h)
- 2xAAA (life 13/39 h)
- 3xAAA (life 15/45 h)
- Lumens: 350>40>OFF
- Charge indicator
- IPX6



L
mm
140

1 018340320

1834PL

high-brightness LED torch,
made of sturdy, anodized aluminium,
up to 500 lumens

- Batteries (not included) :
- 1xAA (life 20/60 h)
- 2xAA (life 28/84 h)
- 3xAA (life 36/108 h)
- Lumens: 500>40>OFF
- Charge indicator

•IPX6



L
mm
210

1 018340325

1834PXL

high-brightness LED torch,
made of sturdy, anodized aluminium,
up to 1350 lumens

- Batteries (not included) : 3xD (life 36/108 hr)
- Lumens: 1350>450>OFF
- Charge indicator
- IPX6



L
mm
315

1 018340330

1834RR

LED torch,
rechargeable in cigarette lighter socket

Adjustable focus
Rechargeable in cigarette lighter socket, 10-28V DC
IP30
130 lumens



1834RR

1 018340520

1835/1

LED inspection torch,
made of sturdy anodized aluminium

1xAAA battery (not included)



L
mm
105

3 018350030

1835/2

LED inspection torch,
made of sturdy anodized aluminium

2xAAA batteries (not included)



L
mm
145

3 018350060

1836A

LED headlamp, dual brightness, with contactless ON/OFF sensor

- 120/65 lumens
- IP54
- Batteries: 3xAAA included



1836A  1 018360050

1836B

rechargeable LED headlamp, dual brightness, with ON/OFF sensor

- Contactless ON/OFF sensor
- 250 lumens
- Life: 3-6 h
- IP65





1836B  1 018360200

1837N

magnetic, articulated lamp with high-brightness LEDs, up to 400 lumens

- Batteries (not included) :
 - 1xAA (life 25/69 h)
 - 2xAA (life 33/96 h)
 - 3xAA (life 43/124 h)
- Lumens: 400>40>OFF
- Charge indicator
- Adjustable focus
- IPX6



1837N  L mm 450  1 018370002



1837/USB

rechargeable, magnetic, articulated lamp with high-illuminated LEDs
micro USB charger not included

- Dual brightness: 150/450 lumens
- Adjustable focus
- Lithium polymer battery
- Charge indicator (green >85%; red <15%)
- Battery life 4-8 hours (depending on brightness)
- Micro USB charging

IPX6



1837/USB  L mm 450  1 018370051

1837RB/USB

spare battery for item 1837/USB

1837/USB RB  1 018370901



1837PLUS

LED spotlight for building yards

- Brightness: 3000 lumens; adjustable (10%; 25%; 50%; 75%; 100%)
- Power supply: 100-240V AC - 50/60Hz; 26W
- impact protection: IK07
- cable: 5 m / 3x1 mm²
- Dimensions: 235 x 83 x 233 mm

CE



1837PLUS  IP67  1 018370026



Beta

1838/11LED

rechargeable inspection lamp with ultra-high brightness LEDs, lithium polymer battery

- Compact body made of antislip rubber
- Easy-to-replace front glass
- Swinging hook
- With charging station, 110-230Vac
- 320 lumens
- With multidirectional head LED



1838/11LED  IP65  1 018380111

1838RA/10-11LED

spare power supplies for items 1838/10LED and 1838/11LED

1838RA/10-11LED  1 018380903

1838RB/10LED

spare battery for items 1838/10LED and 1838/11LED

1838RB/10LED  1 018380902

1838RR/11LED

charging bases for item 1838/11LED

1838RR/11LED  1 018380914

1838RV/11LED

spare scratch-proof glass for lamp 1838/11LED

1838RV/11LED  2 018380905

Beta

1838COB

portable rechargeable LED inspection lamp

- with hanging hook and antislip, shockproof body
- lithium polymer battery
- 100/200 lumens SPOT 75 lumens



1838COB 1 018380010

1838P

rechargeable inspection pen light, with double light emission: lamp and torch

- Compact body made of non-slip rubber
- 50/80 lumens
- Pocket hook
- Magnetic base can be rotated 180 degrees
- Complete with USB/jack charging cable, 3.5mm
- Life: 2.5 hours
- IP20



1838P 1 018380005

1838FLASH

rechargeable, ultracompact spotlight, designed to offer the best possible solution for each use

ABUNDANT READY LIGHTING: with a maximum lighting capacity of 720 lumens, and running on both battery and cable, it is always ready to use.

CAN BE PLACED ANYWHERE:

-on flat surfaces: with rubber feet on three sides or 1/4" drive for stands (camera-like standard)

-on metal structures: with unscrewable magnet or hook that can be rotated 360 degrees.

COMPACT: no more than 85x100x155 mm in size, it can be easily replaced in tool bag and used in small areas.

STURDY: designed to withstand extremely severe mechanical stress. Guaranteed durability.



1838FLASH 1 018380300

1838RB/FLASH

spare battery for item 1838/FLASH

1838RB/FLASH 1 018380930

1838SL

ultra-thin inspection lamp with ultra-high brightness LEDs. For jobs in small areas

- power supply: 12V, with lighter socket and battery terminals
- 2.5-m-long cable
- thickness: 6mm
- 345 lumens



1838SL 1 018380101

1838SLR

rechargeable, articulated LED inspection lamp

compact front LED (200 lumens) and head LED (100 lumens) for inspections
lighting body no more than 9 mm thick
operating range: 5/2.5 hours (depending on light level setting) with USB charger
with metal hook and magnet



1838SLR 1 018380201

1838SN

rechargeable, articulated LED inspection lamp

- articulated
- non-slip rubber body
- double swinging hook
- magnets on base and back for increased adjustability
- with charger 100-240V / 50-60Hz
- double light emission, front and head (spot)
- 250 lumens / spot 150 lumens
- operating range: 3h / spot 3h
- with charge indicator



1838SN 1 018380132

1838UV

rechargeable UV and white light inspection lamp ideal for detecting leaks

- Compact body made of antislip rubber
- With charger 100-240Vac / 50-60Hz
- 150 lumens / UV



1838UV 1 018380150

1839/R1

transformer with USB output, spare part for items 1834L/USB; 1836B; 1837/USB; 1838COB

1839/R1 1 018390501

1839/R2

USB/jack cable 3.5 mm, spare part for items 1836B; 1838P; 1838COB

1839/R2 1 018390502

1839/R3

USB/MicroUSB cable, spare part for item 1834L; 1837/USB

1839/R3 1 018390503

 **Beta**

1840BM

230V inspection lamp,
base type: E27

- Bulb not included



IP20

1840BM	V	W	L	mm	1	018400101
	230	60	420			

1842LED/BM

Lamp with ultra-high brightness LEDs, 100-240 Vac

- 10-m-long cable
- compact body made of antislip rubber
- easy-to-replace front glass
- swinging hook
- 340 lumens
- with multi-directional head LED light



1842LED/BM	1	018420301
------------	---	-----------

1842LED/ABM

Lamp with ultra-high brightness LEDs, 12-24V AC/DC

- 10-m-long cable
- compact body made of antislip rubber
- easy-to-replace front glass
- swinging hook
- 320 lumens
- with multi-directional head LED light



1842LED/ABM	1	018420311
-------------	---	-----------

1843BM

automatic cable reel
with 230 Vac inspection lamp,
base type E27 and steel protector

- Bulb not included



1843BM	1	018430101
--------	---	-----------

1843R/BM

spare inspection lamp for cable reels, base type E27

- Bulb not included



IP20

1843R/BM	1	018430131
----------	---	-----------

1846LED/BM

Automatic cable reel with LED inspection lamp, 100-240 Vac

- With 230/24V safety transformer
- Max. 25 W



1846LED/BM	1	018460301
------------	---	-----------

1846LED/ABM

Automatic cable reel
with LED inspection lamp,
12-24V AC/DC

- Max. 60 W



1846LED/ABM	1	018460311
-------------	---	-----------

1846R-LED/BM

spare LED lamps

12-24V - AC-DC



1846LED/BM R	1	018460331
--------------	---	-----------

1848

automatic cable reel
with Schuko type socket

- Crush-resistant rubber cable H07 - 3x1.5 mm² - 15m
- Max. 1600 W with unwound cable
- Max. 1200 W with wound cable



1848	1	018480015
------	---	-----------

1850B

heat gun

- Pos. 1 240 l/min. 300° C
- Pos. 2 450 l/min. 500° C
- can be used with gun placed vertically on worktop



1850B	L	H	mm	mm	1	018500011
	240	190				

Beta

1850C

heat gun

- Pos. I 150-250 l/min 50°C
- Pos. II 150-500 l/min 50-650°C

- digital display
- buttons designed to adjust temperature and flow capacity
- can be used with gun placed vertically on a worktop
- 4 preset programmes and possibility to customize other programmes

- Prog 1 250°C ca. 350 l/min
- Prog 2 350°C ca. 400 l/min
- Prog 3 450°C ca. 500 l/min
- Prog 4 550°C ca. 400 l/min



CE



1850C	L mm	H mm	1	018500015
	255	210		

1850U...

nozzles for items 1850B and 1850C

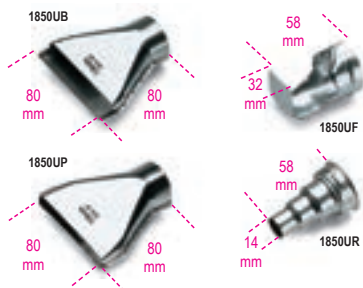

1850U	1850	1	018500100
1850UB	B-C		
1850UF	B-C		
1850UP	B-C		
1850UR	C		

1851VK

hot glue gun with 12 thermofusibile glue sticks in case

CE



1851VK	1	018510058

320x250x50 mm

1851VK-12C

12 thermofusibile glue sticks
Ø 11 mm



1851VK-12C	1	018510062

1851VK-12V

12 thermofusibile glue sticks
for painted surfaces
Ø 11 mm



1851VK-12V	1	018510072

1852R1750

portable induction heater



CE

- heats and loosens bolts, hubs and bearings without using flames
- allows any type of ferromagnetic metal to be heated

Standard equipment:

- two front attachable coils, Ø 19 and 26 mm, for loosening nuts
- one flat coil for heating surfaces
- one flexible coil, 800 mm long
- supplied in plastic case

Technical data:

- input voltage: 230V AC, 50/60 Hz
- input current: max. 7,5A
- power: max. 1.75 kW

OPTIONAL EQUIPMENT

Coils are also available in other sizes

BENEFITS

- Time saving: quick, extremely accurate heating
- Fire safety: does not produce flames, maximum operator safety
- Functional: can be used with one hand, and coils can be easily interchanged

FIELDS OF APPLICATION

- Automotive industry
- Industrial maintenance
- Aviation industry
- Naval industry
- Petrochemical industry

1852R1750	1	018520175

480x370x130 mm - 4,5 kg

1852S-L

side attachable coils



	Ø mm	1	018520501
1852S-L 19	19		
1852S-L 20	20		
1852S-L 23	23		
1852S-L 26	26		
1852S-L 32	32		
1852S-L 38	38		
1852S-L 45	45		

1852S-F

front attachable coil



	Ø mm	1	018520508
1852S-F 19	19		
1852S-F 20	20		
1852S-F 23	23		
1852S-F 26	26		
1852S-F 32	32		
1852S-F 38	38		
1852S-F 45	45		

1852S-FLESS

flexible coil



	1	018520515
1852S-FL 800		
1852S-FL1000		
1852S-FL1500		

1852 S-PIATTE

flat coil



1852S-PIATTE	1	018520516

1860 140A

DC inverter welding machine for MMA and TIG electrode steel welding.
Compact and easy to carry

Arc force, hotstart, anti-sticking and thermostatic protection features

Adjustment current: 5÷140A
Power supply: 1x230V

Use factor (40 °C) :
25% - 140 A
60% - 100 A
100% - 90 A

Delayed fuse: 16 A
Protection: IP23S

Usable electrodes: Ø 1.5- 4mm rutile, basic, stainless steel, cast iron etc.
supplied with 16mm² cables



CE

1860 140A 1 018600004

1860 160A

DC inverter welding machine for MMA and TIG electrode steel welding.
Compact and easy to carry

Arc force, hotstart, anti-sticking and thermostatic protection features

Adjustment current: 5÷160A
Power supply: 1x230V

Use factor (40 °C) :
30% - 160 A
60% - 1030 A
100% - 110 A

Delayed fuse: 25 A
Protection: IP23S

Usable electrodes: Ø 1.5 - 4mm rutile, basic, stainless steel, cast iron etc.
Supplied with 25mm² cables



CE

1860 160A 1 018600006

1860RC

spare cables for inverter welding machines item 1860

electrode holder cable length: 2.5m
earth cable length: 1.8m



1860RC/140A 1 018600604
1860RC/160A 1 018600606

1860SQ

magnetic square, 45°/90°

ideal for locking tubular or flat parts
27 kg magnetic force
no battery required, ON/OFF effect obtained by tilting interior magnets
easier chip removal with magnets in OFF position

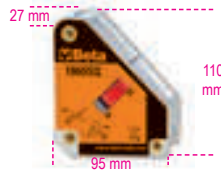

1860SQ 1 018600210

7041LCD/4S

auto-darkening LCD mask, for electrode welding; MIG/MAG; TIG and plasma.
4 sensors
with TRUE COLOR filter
solar cell power supply and lithium batteries for outstanding LCD filter life

- Viewing area: 98x80 mm
- Darkening shade range: 5÷8.5/ 9-13, internally adjustable
- UV/IR protection: DIN16
- Light to dark time: 1/25000 s
- Dark to light time: 0.1-2.0s
- Adjustable darkening sensitivity and delay
- Auto on/off
- Grinding feature
- Low battery indicator
- Ergonomic design, lightweight, well-balanced
- With adjustable ring nut



CE

7041LCD/4S 1 070410001

7041LCD/4S-VE

scratch-proof lens protector for item 7041LCD/4S

7041LCD/4S-VE 2 070410101

7041LCD/4S-VI

inside lens for item 7041LCD/4S

7041LCD/4S-VI 2 070410102

7042LCD

Auto-darkening LCD mask, for electrode welding; MIG/MAG; TIG and plasma.
Solar cells power supply and lithium batteries for outstanding LCD filter life

- Viewing area: 98x43 mm
- Darkening shade: DIN 9-13, externally adjustable
- UV/IR protection
- Light to dark time: 1/25000 s
- Dark to light time: 0.25-1s
- Adjustable darkening sensitivity and delay
- Auto on/off
- Grinding feature
- Optimized shape to make it easier to breathe with pulled-down screen



7042LCD 1 070420001

7042LCD/RV

scratch-proof lens protector for item 7042LCD

7042LCD/RV 2 070420101

7042LCD/RV-INT

inside lens for item 7042LCD

7042LCD/RV-INT 2 070420102

1870

solid and fluid vacuum cleaner, 20 l

- single-stage by-pass motor
- voltage: 230/240 V
- frequency: 50/60 Hz
- max. power: 1200 W
- airflow rate: 58 l/sec.
- max. suction power: 190 mbar
- max. drum capacity: 20 l, made of antistatic PP
- acoustic emissions: <70 dB(A)
- cable length: 5 m
- trolley for accessories
- STANDARD ACCESSORIES, Ø 36 mm
 - 1 corrugated hose with ergonomic handle
 - 2 hard extension tubes
 - 1 multiuse brush for floors and fluids
 - 1 flat nozzle
- FILTERING SYSTEMS
 - 1 surface filter cartridge 1900 cm² - 12 µm nom.
 - 1 anti-foam filter PPI 45/PPI 30

CE



IPX4

1870 1 018700020

1871M

solid and fluid vacuum cleaner, 35 l,
with service power and compressed air outlets

- automatic filter cleaning
 - two-stage by-pass motor
 - voltage: 230/240 V
 - max. power: 1200 W
 - max. service outlet power: 2000 W
 - max. pneumatic tool connection: 15 bar
 - airflow rate: 60 l/sec.
 - max. suction power: 220 mbar
 - max. drum capacity: 35 l, made of antistatic PE-HD
 - acoustic emissions: <68 dB(A)
 - cable length: 7 m
- STANDARD ACCESSORIES
- 1 corrugated hose with ergonomic handle
 - 2 plastic extension tubes
 - 1 combined brush frame
 - 1 section with fluid collection hoses
 - 1 flat nozzle
 - 1 rubber fitting for tool connection; inside Ø: 26 mm
 - 6 air pipe locks, with suction pipe
- FILTERING SYSTEMS
- paper bag; IFA class: "M"
 - filter cartridge; IFA class: "M"
 - anti-foam filter PPI 45/PPI 30

CE



1871M

1 018710035

1871M/AS

solid and fluid vacuum cleaner, 35 l,
with service power and compressed air
outlets,
class "M" certified

- automatic filter cleaning
 - two-stage by-pass motor
 - voltage: 230/240 V
 - max. power: 1200 W
 - max. service outlet power: 2000 W
 - max. pneumatic tool connection pressure: 15 bar
 - airflow rate: 60 l/sec.
 - max. suction power: 220 mbar
 - max. drum capacity: 35 l, made of antistatic PE-HD
 - acoustic emissions: <68 dB(A)
 - cable length: 7 m
- STANDARD ACCESSORIES
- 1 corrugated hose

CE



1871M/AS

1 018710135

1872L

solid and fluid vacuum cleaner, 35 l
"L" class certified

- two-stage by-pass motor
 - voltage: 230/240 V
 - frequency: 50/60 Hz
 - max. power: 1100 W
 - airflow rate: 55 l/sec.
 - max. suction power: 220 mbar
 - max. drum capacity: 35 l, made of antistatic PE-HD
 - acoustic emissions: <68 dB(A)
 - cable length: 6 m
- STANDARD ACCESSORIES, Ø 36 mm
- 1 corrugated hose with ergonomic handle
 - 2 plastic extension tubes
 - 1 combined brush frame
 - 1 section with fluid collection hoses
 - 1 flat nozzle
- FILTERING SYSTEMS
- 1 disposable fabric bag; filtration class: "L"
 - 1 filter cartridge; IFA class: "L"
 - 1 anti-foam filter PPI 45/PPI 30
 - 2 post-filters made of PP-laminated PET

CE



IPX4

1872L

1 018720135

1873

solid and vacuum cleaner, 30 l, stainless steel drum

- two-stage by-pass motor
 - voltage: 230/240 V
 - frequency: 50/60 Hz
 - max. power: 1100 W
 - airflow rate: 55 l/sec.
 - max. suction pressure: 220 mbar
 - max. drum capacity: 30 l, made of stainless steel
 - acoustic emissions: <61 dB(A)
 - cable length: 6 m
 - trolley for accessories
- STANDARD ACCESSORIES, Ø 45 mm
- 1 corrugated hose with ergonomic handle
 - 2 stainless steel extension tubes
 - 1 industrial brush frame
 - 1 industrial section for carpets
 - 1 industrial section with fluid collection hoses
 - 1 flat nozzle
- FILTERING SYSTEMS
- 1 filter paper bag
 - 1 surface filter cartridge 1900 cm², 12 µm nom.
 - 1 anti-foam filter PPI 45/PPI 30

CE



1873 30

1 018730030

1874

solid and fluid vacuum cleaner, 50 l,
stainless steel drum

- two-stage by-pass motor
 - voltage: 230/240 V
 - frequency: 50/60 Hz
 - max. power: 1350 W
 - airflow rate: 55 l/sec.
 - max. suction pressure: 240 mbar
 - max. drum capacity: 50 l, made of stainless steel
 - acoustic emissions: <63 dB(A)
 - cable length: 6 m
 - trolley for accessories
- STANDARD ACCESSORIES, Ø 45 mm
- 1 corrugated hose with ergonomic handle
 - 2 stainless steel extension tubes
 - 1 industrial brush frame
 - 1 industrial section for carpets
 - 1 industrial section with fluid collection hoses
 - 1 flat nozzle
- FILTERING SYSTEMS
- 1 filter bag
 - 1 surface filter cartridge 5200 cm², 12 µm nom.
 - 1 anti-foam filter PPI 45/PPI 30

CE



1874 50

1 018740050

1870-20/5S

5 horizontal paper bags for item 1870



1870 20/5S

1 018700021

1870-72 /FC

cartridge filter 1900 cm² 12 - µm nom.
for items 1870 - 1872 - 1873



1870-72 /FC

1 018700026

1870-72/FL

fluid vacuum cleaning filter
for items 1870 - 1872 - 1873 - 1874



1870 72/FL 1 018700027

1872L 35/FC

cartridge filter, "L" class,
for item 1872L 35



1872L 35/FC 1 018720144

1872L 35/5S

5 disposable fabric bags, "L" class



1872L 35/5S 1 018720136

1873-30/5S

5 vertical paper bags for item 1873



1873 30/5S 1 018730031

1874-50/5S

5 vertical bags for item 1874



1874 50/5S 1 018740051

1874-50/FC

cartridge filter 5200 cm² - 12 µm nom.
for item 1874



1874 50/FC 1 018740056

1877

exhausted oil drain unit, wheeled,
with 90 l tank

- level indicator
- big diameter pan with breakwater grate; capacity: 12 l
- pneumatic tank emptying through 1.8 m pipe
- tool tray

CE



1877 1 018770008

1877A

exhausted oil drain unit / vacuum cleaner,
wheeled,
with 90 l tank and pre-chamber

- level indicator
- big diameter pan with breakwater grate; capacity: 12 l
- transparent pre-chamber: capacity 9.5 l
- 1.8 m suction pipe
- pneumatic tank emptying through 1.8 m pipe
- tool tray

Standard accessories:

- 1 hard probe, Ø 5x700 mm
- 1 flexible probe, Ø 5x700 mm
- 1 hard probe, Ø 6x600 mm
- 1 flexible probe, Ø 6x700 mm
- 1 flexible probe, Ø 7x700 mm
- 1 flexible probe, Ø 8x700 mm
- adapters for VW, BMW, CITROËN

CE



1877A 1 018770080

1878 3

oil collection tank,
for truck hubs
With oil drip catcher



1878 3 3 1 018780003

1878 11

fluid collection tank

- Maximum capacity: 11 l
- Fluid drain plug
- Interior wall for preventing fluid leakage during transportation



1878 11 11 1 018780011

1878 30

fluid collection tank

- Maximum capacity: 30 l
- Splashproof grate
- Fitted with 4 pivoting wheels

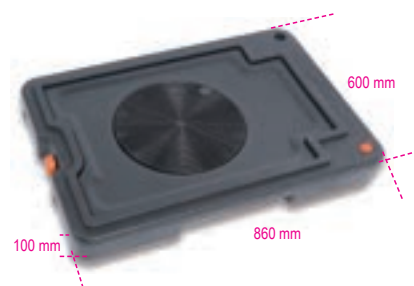

1878 30 30 1 018780030

Beta

1879

9.5 l manual/pneumatic operation fluid extractor



1879

1 018790001

1879 6

manual operation fluid extractor, 6 l



1879 6

1 018790000

1879R/K4

kit of 4 spare tubes for fluid extractor 1879



1879R/K4

1 018790504

1880

manual barrel pump



1880 gr 240

1 018800001

1880ADB

rotary AdBlue® pump

- 5 litres supplied every twenty turns
- drum extensions up to 1.20 m
- 1 fine-pitch drum coupling, fine pitch
- 1 coarse-pitch drum coupling



1880ADB

1 018800101

1881

pneumatic barrel pump, ratio 3:1



1881 l/min 14

1 018810001

1882

oil gun with flexible end and automatic drip catcher

- 1/2"
- Maximum delivery rate: 65 l/min
- Maximum operating pressure: 100 bar
- Lockable delivery lever



1882

1 018820010

1883

digital litre counter for oil

- 1/2"
- Shockproof rubber coating
- Battery: 1 CR2 (included)
- Max. delivery rate: 0÷35 l/min (0÷9 gal/min)
- Max. pressure: 50 bar (750 psi)
- Viscosity: 8÷5000 mPas
- Tolerance: ±0.5%

CE



1883

1 018830035

1883NC

male-male nipple, 1/2, for items 1882 and 1883



1883NC

1 018830135

1884

oil filler tool for manual and automatic gearboxes and differentials

Complete with 12 adaptors for direct connection



1884

1 018840010

AT-101	FORD
AT-102	UNIVERSAL (Bmw, Honda, Nissan...)
AT-103	VW-AUDI
AT-104	VW-AUDI-PORSCHE
AT-105	VW-AUDI-MINI COOPER
AT-106	MERCEDES
AT-107	DSG
AT-108	VW-AUDI CVT
AT-109	VOLVO
AT-110	TOYOTA-LEXUS
AT-111	SKODA
AT-112	VW Passat/Tiguan <2007

 **Beta**

1884/C12

case of adapters for item 1884



1884/C12 1 018840100

1889

steel handling and storage base for 2 200-l barrels

- Completely hot painted with epoxy powder
- Easy to carry with a fork lift truck or a transpallet
- Support cannot be placed under any part

CE



1889 1 018890200

1889CF

universal barrel opening wrench

- 1 female hexagon Ø 38 mm
- 1 4-sector profile Ø 42 mm
- 1 blade 17x7 mm

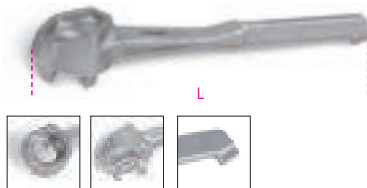

L mm 270 1 018890010

Beta

1885

automatic gearbox maintenance station

Allows entire washing cycle to be safely performed in all automatic transmissions, through a simple, guided procedure. Avoids damage from wear of oil in automatic gearbox, thereby easily and quickly preventing typical malfunctions, including: excessive gearbox noise, jammed gears, abruptly engaged gears, long gear shifting time.



CE



FUNCTIONAL SPECIFICATIONS

Automatic operation
Step-by-step guided procedure with integrated database
Balancing quantity of injected oil with same quantity of exhausted oil, thereby making sure that system always contains proper quantity of oil
Flow meter for visual inspection of oil quantity
Printing records of each operation

AUTOMATIC SPECIFICATIONS

Injecting solvent (optional)
Washing gearbox system
Emptying oil out of sump
Emptying oil out of converter
Injecting oil into converter

TECHNICAL SPECIFICATIONS

Power supply: 220 V 50 Hz
Backlit oil viewers with 2 white light LEDs
2 electronic balances
Electronic balances, resolution +/- 10 g
Electronic card with backlit graphic display

1885 1 018850010

1885/C1

automatic transmission fittings kit for item 1885

Kit contents:

- 1885/C1-R1 Land Rover Freelander transmission fittings
- 1885/C1-R2 DP0 transmission fitting
- 1885/C1-R3 ZF 9HP transmission fitting
- 1885/C1-R4 ZF 9HP transmission dipstick
- 1885/C1-R5 Mercedes transmission dipstick
- 1885/C1-R6 AISIN TG82 transmission fittings
- 1885/C1-R7 AISIN TG81 transmission fittings
- 1885/C1-R8 Renault-Nissan transmission fittings



1885/C1 1 018850110

1885/C1-R1

Land Rover Freelander transmission fittings for item 1885
lc01430



1885/C1-R1 1 018850111

1885/C1-R2

DP0 transmission fitting for item 1885
lc0990



1885/C1-R2 1 018850112

1885/C1-R3

ZF 9HP transmission fitting for item 1885
lc0992



1885/C1-R3 1 018850113

1885/C1-R4

ZF 9HP transmission dipstick for item 1885
lc0192



1885/C1-R4 1 018850114

Beta

1885/C1-R5

Mercedes transmission dipstick for item 1885
K-A-M



1885/C1-R5

1 018850115

1885/C1-R6

AISIN TG82 transmission fittings for item 1885
lc01820



1885/C1-R6

1 018850116

1885/C1-R7

AISIN TG81 transmission fittings for item 1885
lc0150



1885/C1-R7

1 018850117

1885/C1-R8

Renault-Nissan transmission fittings for item 1885
lc02150



1885/C1-R8

1 018850118

1885/C2

automatic transmission fittings kit for item 1885

- Kit contents:
- 1885/C2-R1 Audi 8HP transmission fittings
 - 1885/C2-R2 ZF 9HP transmission fittings without exchanger
 - 1885/C2-R3 Audi 0KC transmission fitting
 - 1885/C2-R4 AG4-ZF 4HP transmission fittings
 - 1885/C2-R5 FIAT transmission fittings
 - 1885/C2-R6 Audi Q5-Q7 transmission fittings
 - 1885/C2-R7 Audi 0B5 transmission fitting



1885/C2

1 018850120

1885/C2-R1

Audi 8HP transmission fittings for item 1885
lc0993



1885/C2-R1

1 018850121

1885/C2-R2

ZF 9HP transmission fittings without exchanger for item 1885
lc0860



1885/C2-R2

1 018850122

1885/C2-R3

Audi 0KC transmission fitting for item 1885
lc02020



1885/C2-R3

1 018850123

1885/C2-R4

AG4-ZF 4HP transmission fittings for item 1885
lc0750



1885/C2-R4

1 018850124

1885/C2-R5

FIAT transmission fittings for item 1885
lc0061



1885/C2-R5

1 018850125

1885/C2-R6

Audi Q5-Q7 transmission fittings for item 1885
lc0680



1885/C2-R6

1 018850126

1885/C2-R7

Audi 0B5 transmission fitting for item 1885
lc01720



1885/C2-R7

1 018850127

1885/C3

automatic transmission fittings kit for item 1885

- Kit contents:
- 1885/C3-R1 Mercedes DSG transmission fitting
 - 1885/C3-R2 POWERSHIFT transmission fitting
 - 1885/C3-R3 Toyota IQ transmission fittings
 - 1885/C3-R4 Mazda transmission fittings
 - 1885/C3-R5 Renault Laguna-Esp transmission fittings
 - 1885/C3-R6 Nissan Juke transmission fittings
 - 1885/C3-R7 AISIN TF71 FV transmission fittings
 - 1885/C3-R8 AISIN TF71 FP transmission fittings
 - 1885/C3-R9 AISIN TF71 FO transmission fittings
 - 1885/C3-R10 AISIN TF71 FS transmission fittings



1885/C3

1 018850130

1885/C3-R1

lc0191



1885/C3-R1

1 018850131

1885/C3-R2

POWERSHIFT transmission fitting for item 1885
lc0190



1885/C3-R2

1 018850132

1885/C3-R3

Toyota IQ transmission fittings for item 1885
lc0991



1885/C3-R3

1 018850133

1885/C3-R4

Mazda transmission fittings for item 1885

Ic02130



1 018850134

1885/C3-R4

1885/C3-R5

Renault Laguna-Esp transmission fittings for item 1885

Ic02150



1 018850135

1885/C3-R5

1885/C3-R6

Nissan Juke transmission fittings for item 1885

Ic02140



1 018850136

1885/C3-R6

1885/C3-R7

AISIN TF71 FV transmission fittings for item 1885

Ic01420



1 018850137

1885/C3-R7

1885/C3-R8

AISIN TF71 FP transmission fittings for item 1885

Ic001420/1



1 018850138

1885/C3-R8

1885/C3-R9

AISIN TF71 FO transmission fittings for item 1885

Ic001420/2



1 018850139

1885/C3-R9

1885/C3-R10

AISIN TF71 FS transmission fittings for item 1885

Ic001420/3



1 018850140

018850140

1893/134A

automatic charging station for R134a gas air conditioners

Fully automatic model, complete with car/lorry database with gas quantities, compressor oil quantities and types, self-diagnosis software for routine maintenance jobs.

Database can be updated via software.

Machine can be operated in both manual mode (provided it is controlled by a human operator step by step)

and in fully automatic mode (without requiring a human operator).



R134A (250 ml)

FUNCTIONAL SPECIFICATIONS

Automatic operation

Car/lorry database with gas quantities and compressor oil quantities and types

Automatic gas recovery from pipe

Compensation of recharged quantity of gas in pipes

Automatic discharge of noncondensable gases

Automatic reporting of defects and required maintenance jobs

Gauges, ø 80 mm

Digital vacuummeter

TECHNICAL SPECIFICATIONS

Gas tank: 15 kg

Vacuum pump: 75 l/min

Electronic balance: 50 kg

Electronic card with backlit display

Recovery rate: 500 rpm

Power supply: 220 V

1893/134A

1 018930001

1893/1234YF

automatic charging station for R1234yf gas air conditioners

Fully automatic model, complete with car/lorry database with gas quantities, compressor oil quantities and types, self-diagnosis software for routine maintenance jobs.

Database can be updated via software.

Machine can be operated in both manual mode (provided it is controlled by a human operator step by step)

and in fully automatic mode (without requiring a human operator).



1234YF (250 ml)

FUNCTIONAL SPECIFICATIONS

Automatic operation

Car/lorry database with gas quantities and compressor oil quantities and types

Automatic gas recovery from pipe

Compensation of recharged quantity of gas in pipes

Automatic discharge of noncondensable gases

Automatic reporting of defects and required maintenance jobs

Gauges, ø 80 mm

Digital vacuummeter

TECHNICAL SPECIFICATIONS

Gas tank: 15 kg

Vacuum pump: 75 l/min

Electronic balance: 50 kg

Electronic card with backlit display

Recovery rate: 500 rpm

Power supply: 220 V

1893/1234YF

1 018930012

1893TR/134A

R134a gas tracer



1893TR/134A 250 ml

1 018930901

1893TR/1234YF

R1234yf gas tracer



1893TR/1234YF 250 ml

1 018930902

1893TR/CI

hybrid compressor tracer



1893TR/CI ml 250 1 018930903

1895G

control generator for (petrol and LPG) electro-injectors and solenoid valves

Makes it possible to autonomously test efficiency of such parts as:

- EGR solenoid valves
- electro-injectors of petrol and LPG engines
- solenoid valves for variable-geometry turbine adjustment
- compressors for new-generation air conditioners



CE

BENEFITS

- Makes it possible to understand whether part is working mechanically
- Combined with ultrasonic cleaning tanks, it allows more efficient cleaning of parts, electronically controlling part during washing phase
- Essential for air conditioner testing, to check whether compressor and its control valve are efficient

SPECIFICATIONS

Petrol and LPG injector control:

- number of outlets: 4
- test duration: 1-60 s
- Operating time: 5-10 ms
- Impulse frequency range: 1-10 Hz

PWM device control:

- number of outlets: 1
- test duration: 1-60 min
- Automatic or manual
- Duty cycle adjustment: 10%-85%
- Signal frequency regulation: 120-250 Hz

Includes 4 connectors with female FASTON terminals

Power supply: 110-220 V

Dimensions: 334x240x74 mm

Weight: 4 kg

1895G 1 018950800

1895/S

adjustable support for ultrasonic cleaning tanks 1895

Allows injectors to be correctly placed during washing in ultrasonic cleaning tank

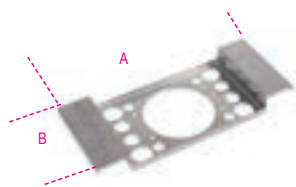

1895/S A mm 340 B mm 140 1 018950501

1895 6

ultrasonic cleaning tank, 6 l

with special degas function



CE

- Ultrasonic cleaning relies on fluid heating to effectively clean spare parts and metal pieces in general (injectors, carburetors, valves etc.)
- Digital display for temperature and cleaning time selection
- Two cleaning modes: "soft" and "normal"
- For normal cleaning, just use water at a temperature of 50/60 °C
- For more accurate cleaning, add non-foaming detergent (e.g. Arexons Fulcron Extra) specific for ultrasonic tanks
- Using the degas mode speeds up air release throughout the tank, thereby improving ultrasonic cleaning efficiency

TECHNICAL DATA

Tank capacity: 6 l

Drain tap

Power: 150 W

Heating power: 300 W

Temperature range: 0+80 °C

Cleaning time range: 0-99 minutes

Frequency: 40 kHz

Power supply: 220/230V

Overall dimensions: 330x180x310 mm

Tank dimensions: 300x155x150 mm

Basket dimensions: 250x105x100 mm

Maximum capacity: 5.5 kg

1895 6 Max 5,5 1 018950060

1895 13

ultrasonic cleaning tank, 13 l

with special degas function



CE

- Ultrasonic cleaning relies on fluid heating to effectively clean spare parts and metal pieces in general (injectors, carburetors, valves etc.)
- Digital display for temperature and cleaning time selection
- Two cleaning modes: "soft" and "normal"
- For normal cleaning, just use water at a temperature of 50/60 °C
- For more accurate cleaning, add non-foaming detergent (e.g. Arexons Fulcron Extra) specific for ultrasonic tanks
- Using the degas mode speeds up air release throughout the tank, thereby improving ultrasonic cleaning efficiency

TECHNICAL DATA

Tank capacity: 13 l

Drain tap

Power: 300 W

Heating power: 400 W

Temperature range: 0+80 °C

Cleaning time range: 0-99 minutes

Frequency: 40 kHz

Power supply: 220/230V

Overall dimensions: 350x325x320 mm

Tank dimensions: 325x235x145 mm

Basket dimensions: 257x185x100 mm

Maximum capacity: 12 kg

1895 13 Max 12 1 018950130

1895 27

ultrasonic cleaning tank, 27 l

with special degas function



CE

- Ultrasonic cleaning relies on fluid heating to effectively clean spare parts and metal pieces in general (carburetors, valves etc.)
- Digital display for temperature and cleaning time selection
- Two cleaning modes: "soft" and "normal"
- For normal cleaning, just use water at a temperature of 50/60 °C
- For more accurate cleaning, add non-foaming detergent solutions specific for ultrasonic tanks
- Using the degas mode speeds up air release throughout the tank, thereby improving ultrasonic cleaning efficiency

TECHNICAL DATA

Tank capacity: 27 l

Drain tap

Power: 500 W

Heating power: 500 W

Temperature range: 0+80 °C

Cleaning time range: 0-99 minutes

Frequency: 40 kHz

Power supply: 220/230V

Dimensions: 530x330x380 mm

1895 27 Max 25 1 018950270

1897

professional bench sander

Particularly recommended for surface finishing jobs on several materials (metal, plastic, glass, ceramic, wood etc.). The cabin is made from properly reinforced sheet steel which results in unparalleled sturdiness and firmness.

The cabin is equipped with the following:

- loading door with magnet closure
- perforated sheet metal top
- standard connection for vacuum cleaners, ø 36 mm
- protective polycarbonate viewing window, 6 mm
- LED lamp
- pneumatic circuit (compressed air inlet)
- sanding gun with trigger operation



CE

TECHNICAL DATA

Useful dimensions of cabin: 600x520x320 mm

Overall dimensions: 660x530x500 mm

Weight: 38 kg

Worktop: perforated sheet metal

Lighting: LED

Air consumption: 340 l/min at 7 atm

Power supply: 220 V - 50 Hz

1897 1 018970066

1897/KSA

bench sander item 1897,
complete with vacuum cleaner item 1871M/AS

CE



1897/KSA

1 018970660

1897/CRB

corundum for sander 1897 in 25 kg bag



1897/CRB

1 018970101

1897/G

garnet for sander 1897 in 25 kg bag



1897/G

1 018970104

1897/MV

glass microspheres for sander 1897 in 25 kg bag



1897/MV

1 018970103

2250-O

heavy duty swivel creeper seat with tray



2250-O

1 022500011

2251-O

heavy duty swivel creeper seat with drawers



2251-O

1 022510011

NOT AVAILABLE IN THE USA, CANADA AND MEXICO

2252

seat with castors

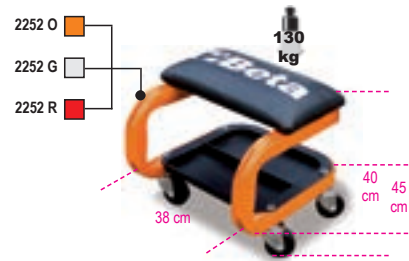

2252-O

1 022520001

2252-G

1 022520002

2252-R

1 022520003

2252KR4

spare seat castors 2252



2252KR4

1 022520900

2258-O

heavy duty creeper with tool chest



2258-O

1 022580011

NOT AVAILABLE IN THE USA, CANADA AND MEXICO

2254C

suction cup protector for vehicles' bodies

Made of plastic-coated fabric, with 4 suction cups on top side



2254C

1 022540200

2254F

car front protector

Allows front part of vehicle to be protected, while leaving openings for headlights and radiator



- Waterproof
- Resistant to oil and grease
- Strap fixing
- Material: 98% polyamide/nylon, 2% polyurethane

2254F

1 022540150

2254SV

reusable seat and steering wheel protector

Suits most car seats and steering wheels



- One size fits all
- Reusable and washable
- Made of hard-wearing nylon with stretch strings
- Material: 98% polyamide/nylon, 2% polyurethane

2254SV

1 022540100

2254T

kneeling pad

made from non-slip EVA foam



2254T 1 022540047

3000M/LT

creeper

• PVC lining with upholstered foamed rubber designed for remarkable comfort

ADJUSTABLE HEAD-REST BY PROGRESSIVE AIR SPRING

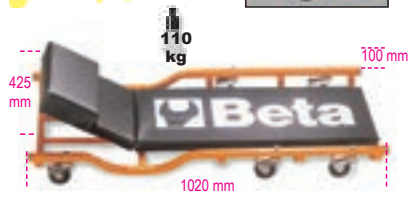

3000M/LT 1 030000220

7,3 kg

3000M/RLS

spare creeper castors



3000M/RLS 1 030000206

3002

creeper and seat

• Steel frame
• PVC lining with upholstery
• Easily convertible into a creeper or a seat



3002 1 030020001

3002/RLS

6 spare wheels for creeper 3002



3002/RLS 1 030020501

3003

creeper

made of shockproof plastic

• Wheel Ø: 76 mm



3003 1 030030001

3003/RLS

6 spare wheels for creeper 3003



3003/RLS 1 030030501

3006

jack and positioner for tractor and excavator wheels

• max. capacity: 1,500 kg
• min. wheel diameter: 1,000 mm
• max. wheel diameter: 2,200 mm
• max. wheel thickness: 800 mm

CE



3006 1 030060000

3007

underbody trolley for vehicles without forecarriage / rear axle

Allows vehicles without forecarriage or rear axle to be easily handled while working
• 4 pivoting wheels, including 2 with brakes, suitable for use in painting furnaces
• 2 sliding supports to fit all chassis
• max. capacity: 800 kg

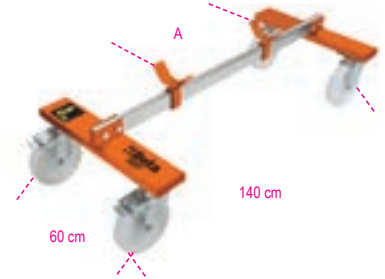

3007 1 030070001

3008

jack and positioner for single and twin truck wheels

• max. capacity: 700 kg
• min. height: 140 mm
• max. height: 660 mm
• distance between rollers: 470÷740 mm
• hydraulic overloading safety device
• front pivoting wheels

CE



3008 1 030080100

3009

wheel lifter

Maximum lifting capacity: 550 kg
4 pivoting rollers
Roller width: 200 mm
For wheels up to 240 mm in width



3009 1 030090001



3009R/GR4

4-wheel groups for trolleys 3009 R/GR4



3009R/GR4 1 030090501

3010/T...

jack stands, pair

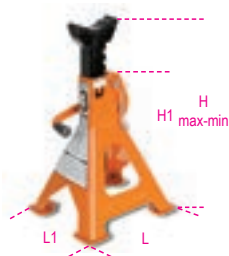

C max	H min	H max	H1	L	L1
kg	mm	mm	mm	mm	mm
2000	280	425	245	185	165

3010T 2 1 030100002

C max	H min	H max	H1	L	L1
kg	mm	mm	mm	mm	mm
3000	285	430	250	180	195

3010T 3 1 030100003

C max	H min	H max	H1	L	L1
kg	mm	mm	mm	mm	mm
6000	400	580	340	245	280

3010T 6 1 030100006

C max	H min	H max	H1	L	L1
kg	mm	mm	mm	mm	mm
10000	471	735	420	330	290

3010T 10 1 030100010

3011/T

hydraulic bottle jacks

CE



C max	H min	H Max	L
kg	mm	mm	mm
3500	170	366	86

3011T 3,5 1 030110035

C max	H min	H Max	L
kg	mm	mm	mm
5000	203	467	118

3011T 5 1 030110050

C max	H min	H Max	L
kg	mm	mm	mm
10000	220	484	114

3011T 10 1 030110100

C max	H min	H Max	L
kg	mm	mm	mm
15000	230	497	113

3011T 15 1 030110150

C max	H min	H Max	L
kg	mm	mm	mm
20.000	245	521	115

3011T 20 1 030110200

3010H

heavy-duty jack stands



C Max	H min	H Max	L	L1
kg	mm	mm	mm	mm
15,000	450	750	300	300

3010H 750 1 030100150

C Max	H min	H Max	L	L1
kg	mm	mm	mm	mm
15,000	650	1100	300	300

3010H 1100 1 030100165

Beta

3010V

heavy-duty jack stands,
screw adjustable



C Max	H min	H Max	L	L1
kg	mm	mm	mm	mm
20,000	470	680	300	300

3010V 680 1 030100200

C Max	H min	H max	L	L1
kg	mm	mm	mm	mm
20,000	680	1170	300	300

3010V 1170 1 030100220

3012

engine brackets



L	C max
mm	kg
1500	500
1800	400

3012C

lower engine bracket

ideal for cars and commercial vehicles



3012C 1 030120255

Beta

3012I

lower engine bracket

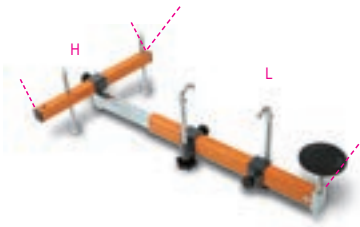

3012I	L mm	H mm	1	030120250
	630=960	190		

3014

engine stand



3014	1	030140010
------	---	-----------

3014R/GR5

5 spare wheels for engine stand 3014



3014R/GR5	1	030140501
-----------	---	-----------

3014 SAR

folding engine stand

- Easy to fold up, for significantly increased compactness
- Allows 360° rotation of engine or gear
- Provides unparalleled safety and stability during jobs

Maximum capacity: 450 kg



3014SAR	1	030140360
---------	---	-----------

3014SAR/RR

4 spare wheels for engine stand 3014SAR



3014SAR/RR	1	030140370
------------	---	-----------

3014SAR/1

fluid collection tank for item 3014 SAR

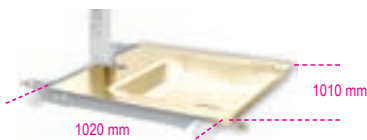

3014SAR/1	1	030140361
-----------	---	-----------

1020x1010x11 mm

3014SAR/2

clamp for fixing transmission gear on stand item 3014 SAR

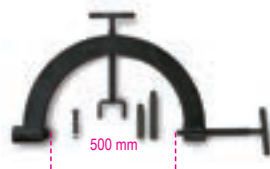

3014SAR/2	1	030140362
-----------	---	-----------

3025

folding hydraulic crane with dual effect pump

Maximum capacity: 1 t

CE



3025	3025	1	030250001
------	------	---	-----------

3025/RF

2 spare fixed wheels for hydraulic crane 3025



3025/RF	1	030250901
---------	---	-----------

3025/RG

2 spare swivel wheels for hydraulic crane 3025



3025/RG	1	030250902
---------	---	-----------

3025/PF

barrel handling pliers

Maximum capacity: 300 kg

CE



3025/PF	A mm	B mm	1	030250011
	550+640	70		

3026 0,3

hydraulic pit and under bridge jack

CE



3026 0,3	1	030260003
----------	---	-----------

3026/R0,3

4 spare swivel wheels for hydraulic jack 3026 0,3



3026/R 0,3	1	030260903
------------	---	-----------

3026 0,5

hydraulic pit and under bridge jack

Maximum capacity: 500 kg

CE



3026 0,5

1 030260005

3026/R0,5

4 spare swivel wheels for hydraulic jack 3026 0,5



3026/R 0,5

1 030260905

3026 1,0

hydraulic pit and under bridge jack

Maximum capacity: 1 t

CE



3026 1,0

1 030260010

3026/R 1,0

4 spare swivel wheels for hydraulic jack item 3026 1,0



3026/R 1,0

1 030260910

3026/S

swivel transmission gear support with reduction bushes for jacks item 3026

Maximum capacity: 500 kg



3026/S

1 030260501

3026/SP

Universal transmission support

Allows one operator to disassemble and reassemble any transmissions of cars, commercial vehicles and off-roaders quickly and safely.



3026/SP

1 030260505

3027 10

hydraulic bench press with moving piston

Maximum capacity: 10 t

CE



3027 10

1 030270010

90 kg

3027 20

hydraulic press with moving piston 20 t

Maximum capacity: 20 t

CE



3027 20

1 030270020

140 kg

3027 30

hydraulic press with moving piston and hoist

Maximum capacity: 30 t

CE



3027 30

1 030270030

230 kg

 **Beta**

3027 50

hydraulic press with moving piston and hoist

Maximum capacity: 50 t

CE



3027 50 1 030270050

350 kg

3027/KP

set of pin punches and plate for press item 3027

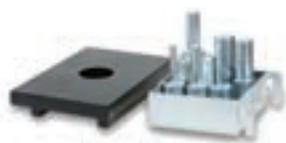

3027/KP10 3027 10 1 030270510

3027/KP20 3027 20 1 030270520

3027/KP30 3027 30 1 030270530

3027/KP50 3027 50 1 030270550

3027/KPP50

pedal control for hydraulic press item 3027 20-30-50



3027/KPP50 1 030270555

3027/PR

press supporting tool for removal/insertion of hubs, bearings and silent blocks

Universal system which allows user to mount/dismount hubs, bearings and silent blocks into/from their housings by operating under a press, through a supporting base and its accessories. Tool can adapt to irregular geometric shapes of hubs/king pins on which operator must work.



TECHNICAL DATA

Working range: min. 130 mm - max. 186 mm

Dimensions: 300 x 300 mm

Weight: 13 kg

Max. load-bearing capacity: 20 t

3027/PR 1 030270400

3029/2T

lowered hydraulic jack, 2 t, with 4 wheels

- Quick approach pedal
- Steel frame and nylon wheels
- Minimum height: 75 mm

CE



3029/2T 1 030290020

3029L/2T

long, lowered jack, 2 t

Makes it possible to work on vehicles with reduced height from the ground and internal lifting point

- Controlled descent speed
- Quick approach pedal
- Nylon wheels

CE



3029L/2T 1 030290120

3029/2T-L/RP

spare 85-mm rubber plate for items 3029/2T and 3029L/2T



3029/2T-L/RP 1 030290502

3029/2T-L/R6

spare rear wheel for items 3029/2T and 3029L/2T



3029/2T-L/R6 1 030290506

3029/2T-L/R5

spare front wheel for jacks item 3029/2T and item 3029L/2T



3029/2T-L/R5 1 030290505

3030/2T

lowered car jack, 2 t with 6 wheels

- dual front tilting wheels made of plastic material (PTFE)
- car jack can be easily handled on uneven, irregular floors
- maximum capacity: 2 tons

CE



3030/2T 1 030300020

43 kg

3030/2T-R5

front wheel with pin for jack 3030 2T



3030 2T/R5 1 030300505

3030/2T-R6

spare rear wheel for item 3030/2T



3030 2T/R6 1 030300506

3030/2TRP

spare 85-mm rubber plate for item 3030/2T



3030/2TRP 5 030300501

3033/3T

hydraulic jack, 3t long version

- For use on commercial vehicles
- Maximum capacity: 3 t
- Polyamide wheels

CE



3033/3T 1 030330030

Beta

3035

tyre trolley

- 2 castors Ø 260 mm
- 2 castors Ø 125 mm
- Maximum carrying capacity: 200 kg
- Forks can be adjusted in 2 positions:
first position: maximum opening 880 mm
second position: maximum opening 980 mm
- Can be used as a top by locking position horizontally



3035 1 030350100

3036

wheel handling base

Non-marking rubber castors



3036 1 030360063

3061/2T

air hydraulic jack, 2 tons - 2 stages

CE



- Fitted with:
- high-resistance three-layer diaphragm and internal telescopic guide
 - end-of-stroke stop and overloading safety valve
 - can also be used on auto lifts

TECHNICAL DATA
capacity: 2 t
weight: 14 kg
power supply pressure: 8-10 bar
height: min.132 - max. 326 mm

3061/2T 1 030610020

3061/2T-P50

50-mm extension for item 3061/2T



3061/2T P50 1 030610021

3061/2T-P100

100-mm extension for item 3061/2T



3061/2T P100 1 030610022

Beta

3065/20-10T

air hydraulic jack, 20-10 t, with case

Portable and lightweight, ideal for road assistance operations



- Supplied with two extensions, 75 and 60 mm long

TECHNICAL DATA
capacity: 20-10 t
weight: 23 kg
power supply pressure: 8-10 bar
air consumption: 400 nl/min

3065/20-10T

1 030650100

3065/40-20T

air hydraulic jack, 40/20 tons

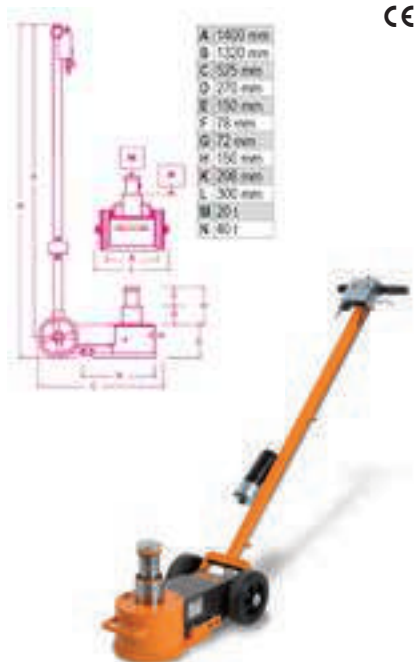

- suitable for use on heavy vehicles
- functional and easy to handle, for transportation on mobile repair shops as well
- automatic piston return
- two descent valves with under load speed control

TECHNICAL DATA
capacity: 40/20 tons
weight: 39 kg
power supply pressure: 8-10 bar
air consumption: 400 l/min

3065/40 20T

1 030650200

3067/60-15T

air hydraulic jack, 60-30-15 t

With a minimum height of no more than 120 mm, it is particularly suitable for use on buses, coaches and public means of transport



- Automatic piston return
- Two descent valves with under load speed control
- supplied with two extensions, 70 and 120 mm long

TECHNICAL DATA
capacity: 60-30-15 t
weight: 56 kg
power supply pressure: 8-10 bar
air consumption: 600 l/min

3067/60-30-15T

1 030670120

3067/70-13T

air hydraulic jack, 70-43-23-13 t

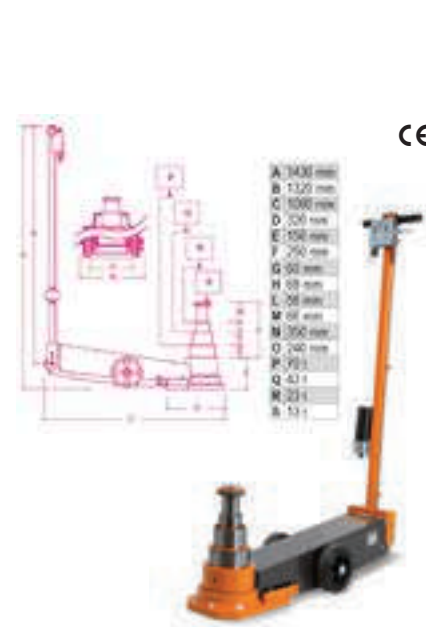

- Long version, suitable for use on lorries, articulated vehicles, buses and coaches, and agricultural machines
- automatic piston return
- two descent valves with under load speed control

TECHNICAL DATA
capacity: 70-43-23-13 tons
weight: 74 kg
power supply pressure: 8-10 bar
air consumption: 600 l/min

3067/70 13T

1 030670130



MOTORCYCLE TOOLS

Beta's products are synonymous with unparalleled quality and reliability, as the result of eighty years of experience and tradition.

Our products are regularly updated, their quality being highly appreciated by the engineers and mechanics of the best racing teams in the Road Racing World Championship Grand Prix, Superbike World Championship, Motocross World Championship and World Enduro Championship.

3040C

rear motorcycle stand, adjustable

- Matt black lacquer
- 4 thermoplastic rubber wheels
- Includes V-shaped sliders, pair
- Includes L-shaped sliders, pair



3040C 1 030400002

3040C/S1

V-shaped sliders, pair, for item 3040C



3040C/S1 1 030400503

3040C/S2

rubber L-shaped sliders, pair, for item 3040C



3040C/S2 1 030400504

3041C

front motorcycle stand, adjustable

- Matt black lacquer
- 4 thermoplastic rubber wheels
- Includes roller sliders, pair
- Includes cone-shaped sliders, pair



3041C 1 030410002

3041C/12

roller sliders, pair, for item 3041C



3041C/12 1 030410512

3041C/16

cone-shaped sliders, for item 3041C



3041C/16 1 030410516

3042C

front stand for motorcycle steering pin

- Matt black lacquer
- 4 thermoplastic rubber wheels
- Includes 8-pin kit Ø 13 - 15 - 15.5 - 17 - 19 - 20 - 21 - 27



3042C 1 030420002

3043C

motorcycle stand with left single arm

- Matt black lacquer
- 4 thermoplastic rubber wheels



3043C 1 030430002

3043C/ 41÷47

pin for item 3043C



	∅ mm	
3043C/41 Ducati	21,5 ÷ 25,5	1 030430551
3043C/42 KTM - Triumph	27,5	1 030430552
3043C/43 MV	42,5	1 030430553
3043C/44 Ducati	40,5	1 030430554
3043C/45 Honda	28,5	1 030430555
3043C/47 BMW	53,5	1 030430557

3047C

pedal stand for cross/enduro motorcycles



3047C 1 030470002

3048C

aluminium racing cross stand



3048C 1 030480002

3050/CC

chock cradle centre stand for Custom, Enduro, Cross, Scooter motorcycles includes adjustable support kit

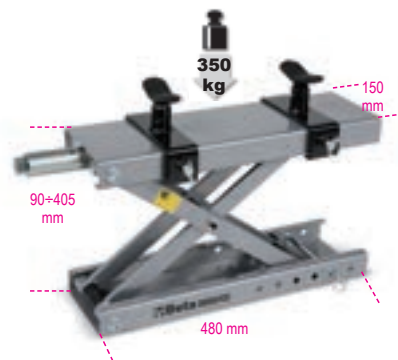

3050/CC 1 030500012

Beta
50 years in motorsports

3050/600

electro-hydraulic motorcycle jack, 600 kg

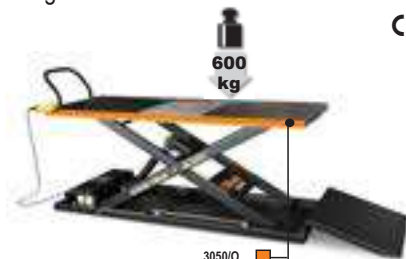

CE

- 3050/O ■
- 3050/G ■
- 3050/R ■

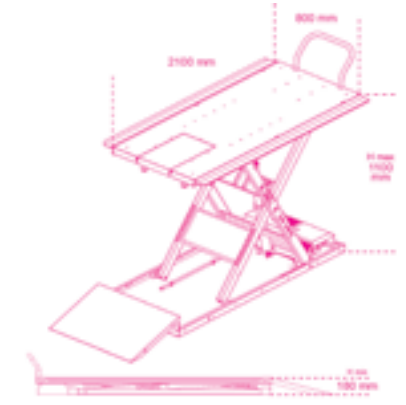

Technical specifications

- Electrical, mechanical and hydraulic safety devices
- Capacity: 600 kg
- Integrated electro-hydraulic unit: 230V - 50 Hz
- Hydraulic pump
- Controlled downward speed
- Safety fuses for protection in case of cable cuts
- control push button panel
- CE-certified, TÜV-approved

	L	L	H	min	H	Max		
	mm	mm	mm	mm	mm	mm		
3050/O	975	2100	185	1110			1	030500201
3050/G	975	2100	185	1110			1	030500202
3050/R	975	2100	185	1110			1	030500203

3050/KA

widening kit for jack item 3050/600

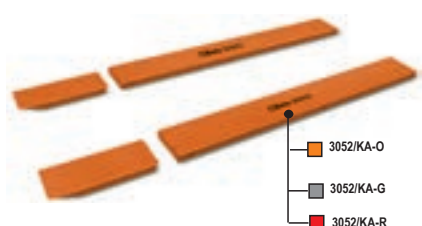

	A	B		
	mm	mm		
3050/KA-O	107,5	2100	1	030500221
3050/KA-G	107,5	2100	1	030500222
3050/KA-R	107,5	2100	1	030500223

3050/MS

wheel clamp for jack item 3050/600
allows motorcycle front wheel to be locked to bridge



3050/MS	1	030500032
---------	---	-----------

3050/LA

non-slip sheet metal top for jack item 3050/600

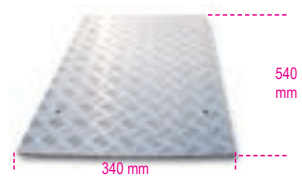

3050/LA	1	030500062
---------	---	-----------

9562T3

garage mat
Dimensions: 300x160 cm

- particularly suitable for use under motorcycle jacks
- protects floor from oil and petrol leaks, environmentally friendly
- easy to clean, anti-skid, rubber-coated bottom



9562T3	1	095620300
--------	---	-----------

3054

moving base for central stand or motorcycle rear wheel
with extension for side stand



3054	1	030540000
------	---	-----------

3055M

automatic van clamp
Allows motorcycle front wheel to be fixed



3055M	1	030550002
-------	---	-----------

3057

aluminium ramp for loading/unloading motorcycles

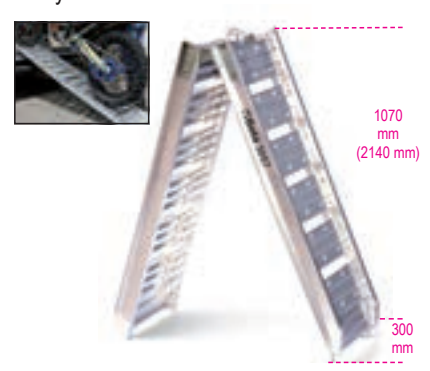

3057	1	030570001
------	---	-----------

3070B

manual static balancer



- Allows wheel balancing both in the workshop and on racing tracks
- Equipped with rolling bearings, rabbet level and adjustable feet for unparalleled precision
- Comes with 2 hub cones

3070B	1	030700100
-------	---	-----------

3073

universal fork oil seal driver fitting tool



for fork tube diameters 35 ÷ 48 mm



3073	1	030730001
------	---	-----------

3075A

hexagon socket for wheel hub nuts



	Ø	Ø	L		
	mm	mm	mm		
3075A 28	28	38	30	1	030750028
3075A 30	30	40	30	1	030750030

3075B

bi-hex socket
for wheel hub nuts

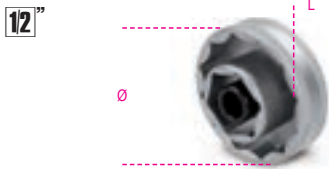

	mm	mm	mm		
3075B 55	55	70,7	25	1	030750155

3075MV

bi-hex socket for MV AGUSTA wheel hub nuts



	mm	mm	mm		
3075MV 56	56	70,7	30	1	030750156

3075/CM

multiple hexagon socket
for wheel pins



3075/CM	12-14-17-19-22-24 mm	1	030750212

3075/K10

set with a universal wrench with
interchangeable head
and 10 bits, for tightening wheel spokes

Sizes: 5.2 - 5.4 - 5.6 - 5.8 - 6.0 - 6.2 - 6.4 - 6.6 - 6.8 - 7.0



3075/K10	1	030750410
----------	---	-----------

3079/21

cable oiler

Allows proper lubrication
of clutch cables and gas control,
for increased sheath smoothness and cable duration.



3079/21	1	030790021
---------	---	-----------

3080/C15

chain opening and riveting kit

ø 3-4-5 mm and Regina kit



3080/C15	1	030800015
----------	---	-----------

420x185x60 mm

3080R/CS3

kit with 3 spare pin punches for chain tool
3080/C15

ø 3-4-5 mm



3080R/CS3	1	030800503
-----------	---	-----------

3081

portable chain tool

Sturdy and foldable, easily fitting into enduro tool bags.
Suitable for chain sizes 415, 420, 428, 520, 525, 530, 532



3081	1	030810010
------	---	-----------

3085

tool for retracting brake pistons

Suitable for motorcycle and scooter brake callipers



3085	1	030850010
------	---	-----------

3091

flywheel pullers
with internal thread



	M		
3091/10	24x1,5	1	030910010
3091/20	26x1,0	1	030910020
3091/30	28x1,0	1	030910030
3091/40	30x1,0	1	030910040
3091/45	30x1,5	1	030910045
3091/50	32x1,5	1	030910050
3091/60	33x1,5	1	030910060
3091/70	35x1,0	1	030910070
3091/75	35x1,5	1	030910075
3091/80	38x1,5	1	030910080

3092

flywheel pullers
with external thread



	M		
3092/10	18x1,5	1	030920010
3092/20	19x1,0	1	030920020
3092/30	27x1,25	1	030920030
3092/35	22-26x1,5	1	030920035
3092/40	25x1,5	1	030920040
3092/50	26-28x1,0	1	030920050
3092/60	28x1,5	1	030920060

3093/E

tool for locking flywheel, clutch bell and pulleys



3093/E	1	030930100
--------	---	-----------

3093/U

multiple flywheel puller



3093/U	1	030930050
--------	---	-----------

M10x1.25R
M14x1.5R
M16x1.5R
M18x1.5R
M24x1.0R
M27x1.0L



BICYCLE TOOLS



Partnership 2019

We partner UAE Team Emirates, which is led by the General Manager, Giuseppe Saronni, and competes at UCI World Tour level.

3912T

TOP workshop workbench for bicycle maintenance

- With support for central movement
- Tool drawer



3912T 1 039120010

3912P

PRO workshop workbench for bicycle maintenance

- With support for central movement
- Tool drawer



3912P 1 039120110

3916MM

workshop single-sided clamp for bicycle maintenance

- Clamp can be rotated 360°



3916MM 1 039160110

3921

derailleur hanger alignment gauge

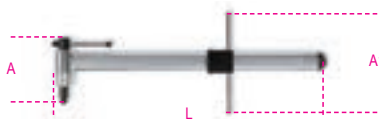

L	A	A1	
mm	mm	mm	
440	115	165	1 039210010

3923

blade guide tool for cutting airfoil shaped seatposts up to 80 mm and tubes 1" ÷ 1.1/2"

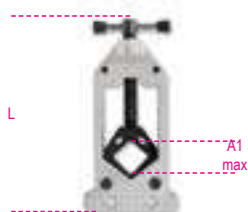

L	A1 max	Ø max	
mm	mm	mm	
160	80	45	1 039230010

3927

handlebar clamp



	L	
	mm	
3927	365	1 039270010

3932U

professional chain tool compatible with chains from 5 to 11 speeds



L	L1	
mm	mm	
164	115	1 039320011

3935

chain wear indicator



L	
mm	
120	1 039350010

3937

missing link pliers



L	
mm	
170	1 039370010

3948

crank extractor

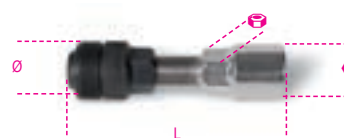

Ø	L	Ø		
mm	mm	mm		
14	79	20	15	1 039480015

3952

simple cone wrench



Ø	L	
mm	mm	
13	205	2 039520013
14	205	2 039520014
15	205	2 039520015
16	205	2 039520016
17	205	2 039520017
18	205	2 039520018
19	205	2 039520019
20	205	1 039520020
21	205	1 039520021
22	205	1 039520022
24	205	1 039520024



3952/S7	1 039520207
13-14-15-16	
17-18-19 mm	



3953

pedal wrench



mm	L	
15	401	1 039530015

3955

open end wrenches for universal headsets



mm	L	
30x32	292	1 039550108
32x36	319	1 039550114

3961 3,2

spoke wrench, black, 3.2 mm



mm		
3,2	1 039610032	

3961 3,3

spoke wrench, green, 3.3 mm



mm		
3,3	1 039610033	

3961 3,5

spoke wrench, red, 3.5 mm



mm		
3,5	1 039610035	

3961U

professional spoke wrench, 3.2 - 4.0 mm



mm		
3,2 - 4,0	1 039610100	

3962SH

double spoke wrench for Shimano



L	A1	A2	
mm	mm	mm	
132	4,3	4,4	1 039620010

3962MV

double spoke wrench for Mavic



L	A1	A2	
mm	mm	mm	
135	4,3	8,4	1 039620020

3963P

special wrench for flat spokes



L		
mm		
129	1 039630010	

3964

special nipple driver



L	L1	
mm	mm	
170	89	1 039640010

3965wheel alignment gauge, \varnothing 20" \div 29"

L		
mm		
680	1 039650010	

3965C

professional wheel truing stand



- For \varnothing 20" \div 29" (29" without tyre)
- Through axle hub adapter, 10 \div 20mm



L	L1	A	
mm	mm	mm	
500	380	285	1 039650110

3967

sprocket removal wrench with chain whip



- Caters for up to 11 speed cassettes
- 2PVC handle
- Also suitable for fixed wheels



L		
mm		
289	1 039670010	

3969

tyre lever



L	A	
mm	mm	
200	15,6	1 039690010

3969K3

kit with 3 tyre levers, made of plastic



L		
mm		
113	1 039690130	

3971

wrench for Shimano plastic bolts



- Suitable for Shimano Hollowtech II cranksets



N°	mm	
8	8	1 039710010

3972

bottom bracket removal wrench

- Suitable for Shimano® Hollowtech II, Campagnolo® Ultra-torque, FSA®, SRAM®



L mm	1	039720010
252		

3973PF

Press-Fit bearing removal tool

- Suitable for inside Ø 24 mm and 30 mm

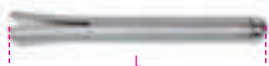

L mm	1	039730001
240		

3973/1

16-notch bottom bracket removal socket

- Suitable for Shimano® XTR BB93, Dura-Ace® BB9000



Ø mm	● mm	L mm	1	039730010
39	24	34		

3973/2

16-notch bottom bracket removal socket

- Suitable for Shimano® BBR60 (Ultegra® 11 speeds)

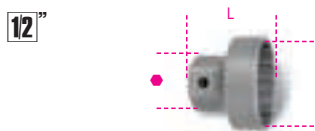

Ø mm	● mm	L mm	1	039730020
41	24	35		

3973/3

16-notch bottom bracket removal socket

- Suitable for Shimano® Hollowtech II, Campagnolo® Ultra-torque, FSA®, SRAM®

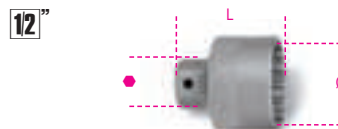

Ø int. mm	● mm	L mm	1	039730030
46	24	53,5		

3973/4

20-notch bottom bracket removal socket with central pin, nickel-plated

- Suitable for Shimano and ISIS



Ø mm	L mm	● mm	1	039730040
31,5	55	24		

3975

bearing cup press

- For headset cup assembly, compatible with headset cups 1", 1.1/8", 1.1/4", 1.1/2" and 2"



L mm	Ø mm	1	039750010
360	16x1		

3984/1

BMX freewheel removal wrench, 2 grafts

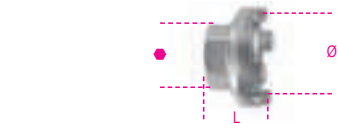

Ø mm	L mm	● mm	1	039840010
35	25,5	24		

3984/2

Shimano freewheel removal wrench

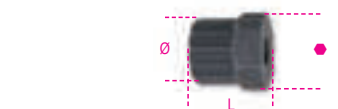

Ø mm	L mm	● mm	1	039840020
22,8	26	24		

3984/3

Shimano freewheel removal wrench, cassette with guide pin

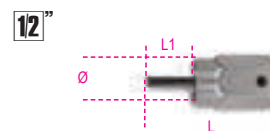

Ø mm	L mm	L1 mm	1	039840030
23,5	65	25		

3984/4

Campagnolo freewheel removal wrench, with guide pin

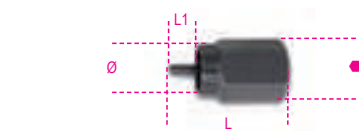

Ø mm	L mm	L1 mm	● mm	1	039840040
23	51	13	24		

3984/5

freewheel removal wrench, 2 grafts



Ø mm	L mm	● mm	1	039840050
18,5	38	21		

3984/6

freewheel removal wrench, 4 grafts



Ø mm	L mm	● mm	1	039840060
19,5	36	21		

3991

lever for pushing back disc brake pads



L mm	A mm	α	1	039910010
222	36	7°		

3992

disc brake straightener



L mm	A1 mm	1	039920010
234	4 55 2,2		

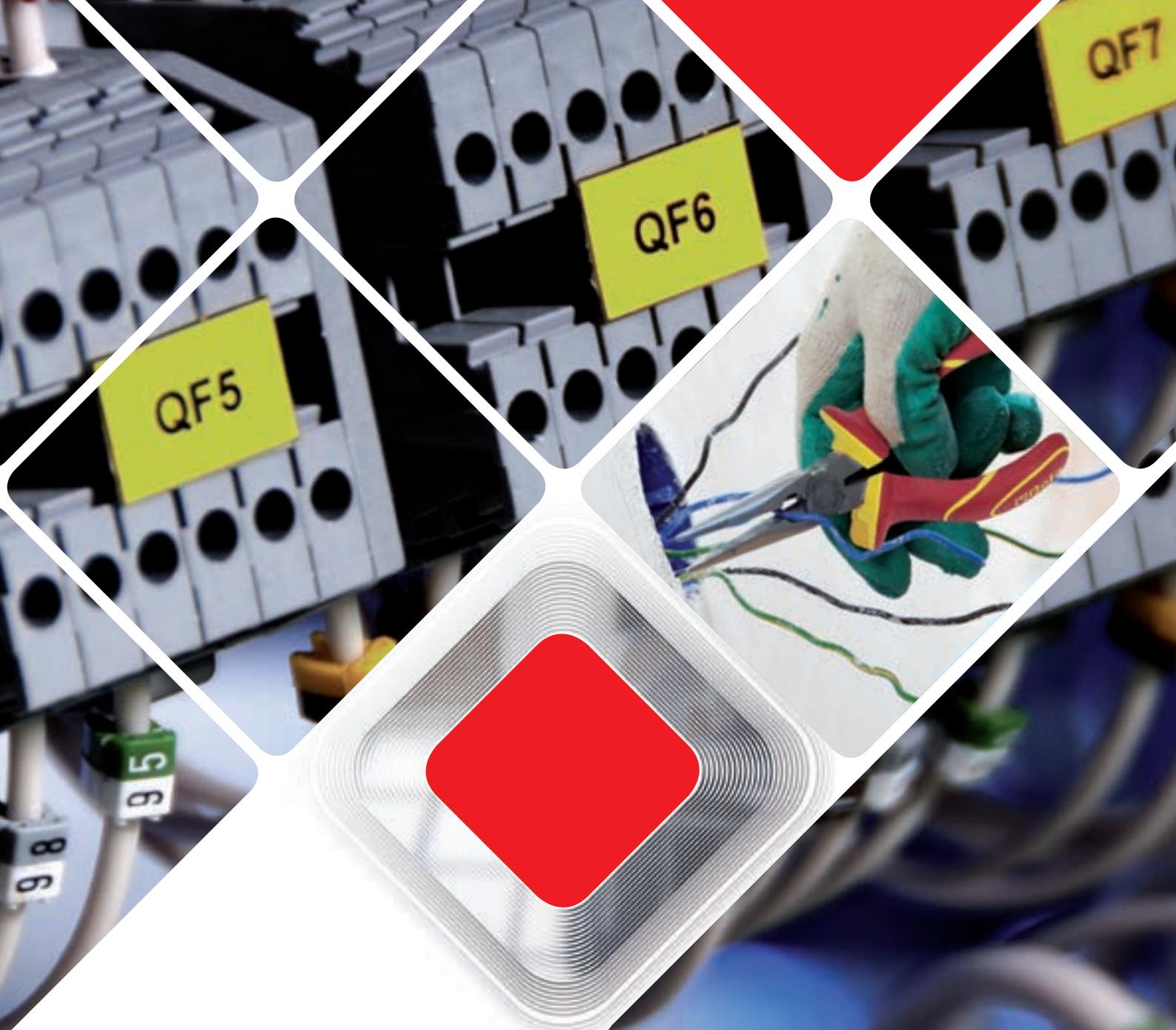

INSULATED TOOLS

Beta Utensili's insulated tools are meant to guarantee installation and electrical maintenance men's safety. All of the insulated tools make it possible to work on systems up to 1000V on alternating current and up to 1500V on direct current. To provide the highest quality and performance standards and verify fitness and compliance with EN 60900, each tool is subjected to the following stringent tests: handle resistance to slipping and flame propagation, and high voltage test (10000V). For assortments and thermoformed trays, see relevant sections.

All of Beta's insulated tools are built in accordance with the specifications of EN60900 and are approved by the best European certification institutions



Istituto Italiano del Marchio di Qualità - I



Verband der Elektrotechnik
Elektron Informationstechnik - D

1000 V

SAFETY TESTS: tested at 10,000 V to work on 1,000 V electrical installations.

Beta's high-insulation tools are tested piece by piece at 10 kV, with a view to providing unparalleled quality for working instruments which are required to ensure ultra-high safety standards: they make it possible to work at voltages up to 1,000 V a.c. (1,500 V d.c.).

SAFETY STANDARDS:

Although extremely stringent tests are performed during production, before using a tool, the operator must always check the insulating handle for tears, modifications or damage. Keeping the dielectric properties unchanged in time is closely connected with the mechanical, chemical or thermal stress the tool may be subjected to. In case the insulator should get damaged, the tool cannot be considered safe for use in live installations. Always wear protective goggles and insulated gloves.

TESTS PERFORMED DURING PRODUCTION



100% visual test:

All the surface finishes of the tools must be free from externally visible defects

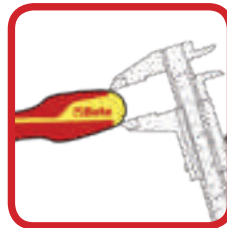

Dimensional test:

All the dimensions of the tools must comply with the design specifications.

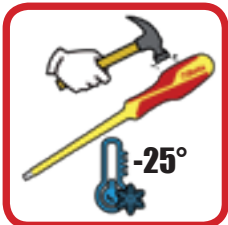

Crash test:

After 2 hours at -25 °C, the tool is hit three times (by such a specific weight as provided for by the standard); the insulating handle must not show any signs of damage.

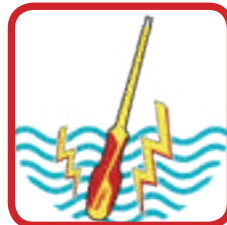

Electrical insulation test:

Following immersion in water for 24 hours, the tool is subjected to a voltage of 10 kV for 3 minutes. Current dissipation must not exceed such values as provided for by the standard.



Penetration test:

A weight of 2 kg is applied to the tool handle at +70 °C for two hours. Later a voltage of 5 kV is applied to the area that is subjected to mechanical pressure for 3 minutes. No signs of current passing through must be shown.

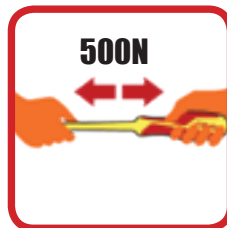

Adhesion test:

after 168 hours at +70 °C, the tool is subjected to a load of 500 N to check that the handle does not slip off.



Mechanical test:

The tools must satisfy such mechanical performance requirements as provided for in the relevant ISO standards

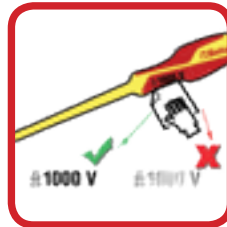

Marking indelibility test:

Following the friction test with isopropyl alcohol, markings must remain legible.



Flame propagation test:

A flame is directed towards the tool for 10 seconds; during the next 20 seconds, the flame must not exceed a height of 120 mm.



52MQ

single open end wrenches



EN 60900

mm	L mm		
6	90	1	000520106
7	95	1	000520107
8	100	1	000520108
9	105	1	000520109
10	110	1	000520110
11	120	1	000520111
12	132	1	000520112
13	140	1	000520113
14	146	1	000520114
15	166	1	000520115
16	167	1	000520116
17	168	1	000520117
18	170	1	000520118
19	176	1	000520119
21	190	1	000520121
22	200	1	000520122
24	225	1	000520124
27	230	1	000520127
30	250	1	000520130
32	280	1	000520132

89MQ

single ring wrenches



EN 60900

mm	L mm		
6	150	1	000890106
7	155	1	000890107
8	155	1	000890108
9	160	1	000890109
10	170	1	000890110
11	180	1	000890111
12	190	1	000890112
13	195	1	000890113
14	200	1	000890114
15	210	1	000890115
16	216	1	000890116
17	218	1	000890117
18	236	1	000890118
19	240	1	000890119
21	250	1	000890121
22	255	1	000890122
24	280	1	000890124
27	300	1	000890127
30	320	1	000890130
32	340	1	000890132

110MQ

adjustable wrench with scale



EN 60900

L mm	A max		
200	28	1	001100520
250	30	1	001100525
300	30	1	001100530

606MQ/25

click-type torque wrench with reversible ratchet

with socket retaining system



EN 60900
UNI EN 26789
ISO 6789

Nm	Kgfm	lbf.ft	L1 mm	L mm	g
2÷25	0,2÷2,5	2÷18	80	250	920

606MQ/25 1 006060702

606MQ/50

click-type torque wrench with reversible ratchet



EN 60900
UNI EN 26789
ISO 6789

Nm	Kgfm	lbf.ft	A mm	L mm	g
5÷50	0,5÷5	4÷40	90	375	1130

606MQ/50 1 006060705

850MQ

magnetic bit holder, insulated, with bimaterial handle



IMQ CSV
EN 60900

L mm	L1 mm	D mm		
233	125	12,5	1	008500910

910MQ/B

bi-hex sockets



EN 60900

mm	L mm	Ø1 mm	Ø mm		
6	45	14	24	1	009100616
7	45	15	24	1	009100617
8	45	16	24	1	009100618
9	45	17	24	1	009100619
10	45	19	24	1	009100620
11	45	20	24	1	009100621
12	45	24	24	1	009100622
13	45	24	24	1	009100623
14	45	25	24	1	009100624
15	45	27	24	1	009100625
16	45	27,5	24	1	009100626
17	45	30	24	1	009100627
18	45	31	24	1	009100628
19	45	32	24	1	009100629

910MQ/PE

socket drivers for hexagon screws



EN 60900

mm	Ø mm	L mm		
4	24	100	1	009100604
5	24,5	100	1	009100605
6	25,0	100	1	009100606
8	25,0	100	1	009100608
10	25,5	100	1	009100610

910MQ/TX

socket drivers for Torx® head screws



EN 60900

mm	Ø mm	L mm	L1 mm		
15	23	116	61	1	009100641
20	24,5	116	65	1	009100642
25	24,5	116	65	1	009100643
27	24,5	116	65	1	009100644
30	24,5	116	65	1	009100645
40	24,5	116	65	1	009100646

910MQ/XZN

socket drivers with XZN® profile

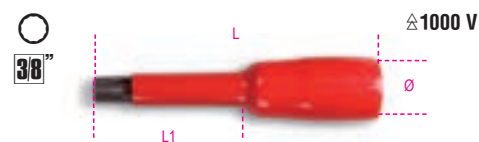

EN 60900

mm	Ø mm	L mm	L1 mm		
M8	24	106	57	1	009100658
M10	24	106	57	1	009100660

910MQ/PT

preset extensions with 3/8" female drive



EN 60900

Nm			
12	1	009100801	

910MQ/21

3/8" drive extension



EN 60900

L mm	Ø mm	
125	24	1 009100804

910MQ/22

3/8" drive extension



EN 60900

L mm	Ø mm	
250	24	1 009100805

910MQ/T

3/8" drive, T-handle

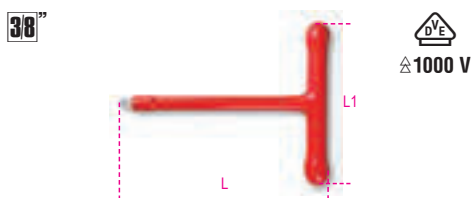

EN 60900

L mm	L1 mm	
200	165	1 009100807

910MQ/55

3/8" drive reversible ratchet



EN 60900

L mm	D mm	A mm	
203	41	67	1 009100808

910MQ/C16

8 bi-hex sockets,
4 hexagon socket drivers
and 4 accessories



EN 60900

910MQ/C16 1 009100917

- 910MQ/B 8 - 10 - 11 - 12 - 13 - 14 - 17 - 19 mm
- 910MQ/PE 4 - 5 - 6 - 8 mm
- 910MQ/21 125 mm
- 910MQ/22 250 mm
- 910MQ/T
- 910MQ/55

920MQ/A

hexagon sockets



EN 60900

Ø mm	L mm	Ø1 mm	
8	21,5	27,5	1 009200238
9	21,5	27,5	1 009200239
10	21,5	27,5	1 009200240
11	21,5	27,5	1 009200241
12	23,0	27,5	1 009200242
13	23,0	27,5	1 009200243
14	23,0	27,5	1 009200244
16	23,0	27,5	1 009200246
17	30,0	27,5	1 009200247
18	32,0	27,5	1 009200248
19	32,2	27,5	1 009200249
20	32,0	27,5	1 009200250
21	34,0	27,5	1 009200251
22	36,0	27,5	1 009200252
24	39,0	27,5	1 009200254
27	42,0	27,5	1 009200257
30	44,0	27,5	1 009200260
32	48,0	27,5	1 009200262

920MQ/PE

socket drivers for hexagon screws



EN 60900

Ø mm	L mm	L1 mm	
*4	28,5	94,50	1 009200264
*5	28,5	94,5	1 009200265
*6	28,5	94,5	1 009200266
*8	28,5	94,5	1 009200268
10	28,5	94,5	1 009200267
12	28,5	94,5	1 009200269

920MQ/21

1/2" square drive extension bar



EN 60900

L mm	Ø mm	
135	28	1 009200804

920MQ/22

1/2" square drive extension bar



EN 60900

L mm	Ø mm	
264	30	1 009200805

920MQ/T

1/2" square drive, T-handle

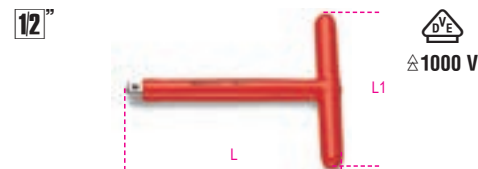

EN 60900

L mm	L1 mm	
200	163	1 009200807

920MQ/55A

1/2" square drive reversible ratchet
with socket locking system



EN 60900

L mm	D mm	A mm	
240	50	89	1 009200809

Beta

920MQ/C16

9 hexagon sockets,
3 socket drivers for hexagon screws
and 4 accessories

12"



1000 V

EN 60900

920MQ/C16 1 009200917

- 920MQ/A 8 - 10 - 12 - 13 - 14 - 17 - 19 - 22 - 24 mm
- 920MQ/PE 5 - 6 - 8 mm
- 920MQ/21 135 mm
- 920MQ/22 264 mm
- 920MQ/55A
- 920MQ/T

420x280x60 mm - 5,2 kg

943MQ

hexagon nut spinners with handles

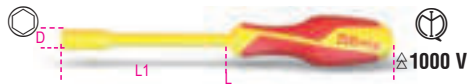

EN 60900

mm	L mm	L1 mm	D mm	1	009430235
5,5	233	125	12,2	1	009430235
6	233	125	12,5	1	009430236
7	240	125	14,3	1	009430237
8	240	125	15,3	1	009430238
10	252	125	17,3	1	009430240
13	252	125	21,3	1	009430243

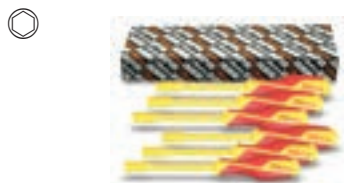

943MQ/S6 1 009430250
5,5-6-7-8-10-13 mm

951MQ

T-handle wrenches with hexagon
male ends



EN 60900

mm	L mm	L1 mm	1	009510703
3	120	105	1	009510703
4	165	105	1	009510704
5	170	105	1	009510705
6	168	105	1	009510706
8	165	105	1	009510708
10	200	105	1	009510710

993MQ

bent knurled point spring tweezers



EN 60900

L mm	1	009930040
147	1	009930040

994MQ

straight knurled point spring tweezers



EN 60900

L mm	1	009940040
145	1	009940040

1010MQ

long round nose pliers



EN 60900

L mm	L1 mm	1	010100096
160	51,5	1	010100096

1048MQ

slip joint pliers, boxed joint

• Chrome-plated finish



EN60900

L mm	A max mm	L1 mm	1	010480315
250	48	39	1	010480315

1082MQ

diagonal cutting nippers



EN 60900

L mm	L1 mm	mm	1	010820094
140	20	1,6	1	010820094
160	22	1,6	1	010820096

1084MQ

heavy duty diagonal cutting nippers



EN 60900

L mm	L1 mm	mm	1	010840100
200	26	2,0	1	010840100

1088MQ

end cutting nippers



EN 60900

L mm	L1 mm	mm	1	010880096
160	7	1,6	1	010880096

2115P L-MQ32



2115PL-MQ32 300

1128MQ

electrician's scissors, stainless steel blades,
with microteeth



IEC60900

L mm	L1 mm	1	011280101
145	45	1	011280101

1132MQ

cable cutter with insulated handles
for copper and aluminium cables



EN 60900

L mm	mm	1	011320193
230	18	1	011320193

1142MQ

wire stripping pliers



EN 60900

L mm	mm ²		
160	0,5÷6	1	011420096

1150MQ

combination pliers, bright chrome-plated

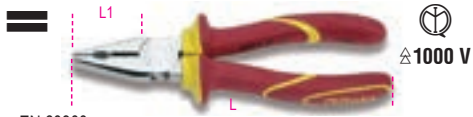

EN 60900

L mm	L1 mm	mm	
160	37	1,6	1 011500096
180	39	1,8	1 011500098
200	43	2,0	1 011500100
220	46	2,0	1 011500102

1162MQ

extra long flat nose pliers



EN 60900

L mm	L1 mm	mm	
160	56	1,6	1 011620096
200	76	1,6	1 011620100

1164MQ

extra-long bent flat nose pliers

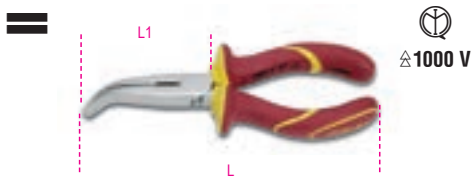

L mm	L1 mm	mm	
160	54	1,6	1 011640096
200	76	1,6	1 011640100

1166MQ

extra long needle nose pliers



EN 60900

L mm	L1 mm	mm	
160	56	1,6	1 011660096
200	76	1,6	1 011660100

1168MQ

extra long bent needle nose pliers



EN 60900

L mm	L1 mm	mm	
160	50	1,6	1 011680096
200	70	1,6	1 011680100

1272MQ/F

screwdrivers for cross head Phillips® screws

slim

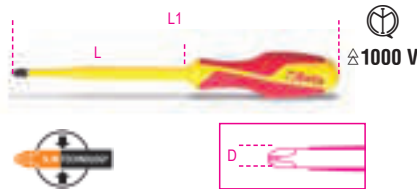

EN60900

PHxDxL mm	L1 mm		
1x4,5x80	187	3	012720409
2x6x100	218	3	012720418

1272MQ

screwdrivers for cross head Phillips® screws

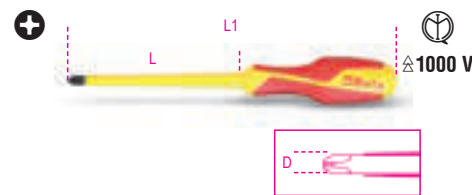

EN 60900

PHxDxL mm	L1 mm		
0x3x60	160	3	012720703
1x4,5x80	187	3	012720709
2x6x100	218	3	012720718
3x8x150	276	2	012720724
4x10x200	326	2	012720727



1272MQ/S5		1	012720751
PH0x3x60-PH1x4,5x80			
PH2x6x100-PH3x8x150			
PH4x10x200 mm			

1273MQ/F-D6

set of 6 slim screwdrivers

1274MQ/F: 0.5x3.5x100 - 0.8x4.5x100 - 1x5.5x125 - 1.2x6.5x150 mm

1272MQ/F: PH1x4.5x80- PH2x6x100 mm



1273MQ/F-D6

1274MQ/F 0.5x3,5x100 - 0.8x4,5x100 -
1x5,5x125 - 1.2x6,5x150 mm

1272MQ/F PH1x4.5x80- PH2x6x100 mm

1273MQ/D6

set of 6 screwdrivers



1273MQ/D6

1274MQ 0,5x3x100 -0,8x4x100
1,0x5,5x125 mm

1272MQ PH0x3x60 -PH1x4,5x80
PH2x6x100 mm

1274MQ/F

screwdrivers for headless slotted screws

slim

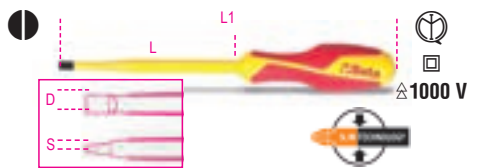

EN60900

SxDxLmm	L1 mm		
0.5x3.5x100	200	3	012740403
0.8x4.5x100	205	3	012740406
1x5.5x125	232	3	012740409
1.2x6.5x150	268	3	012740412

Beta

1274MQ

screwdrivers for headless slotted screws

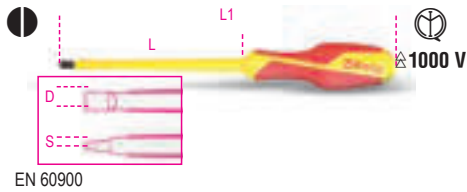

EN 60900

SxDxL mm	L1 mm		
0,4x2,5x75	175	3	012740700
0,5x3x100	200	3	012740703
0,8x4x100	207	3	012740706
1x5,5x125	232	3	012740709
1,2x6,5x150	268	3	012740712
1,2x8x175	301	2	012740715
1,6x10x200	326	2	012740718

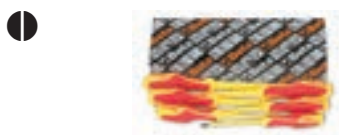

1274MQ/S6	
0,5x3x100-0,8x4x100	1 012740751
1x5,5x125-1,2x6,5x150	
1,2x8x175-1,6x10x200 mm	

1275MQ/C

screwdrivers for combined cross head PH + slotted head screws

slim

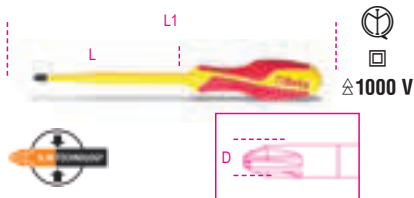

EN60900

PH1+LPP	2	012750409
PH2+LPP	2	012750418

1276MQ/C

screwdrivers for combined cross head PZ + slotted head screws

slim

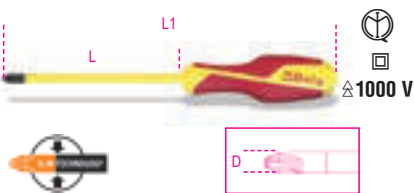

EN 60900

PZ1+LPP	2	012760409
PZ2+LPP	2	012760418

1279MQ/F

screwdrivers for cross head Pozidriv®-Supadriv® screws

slim

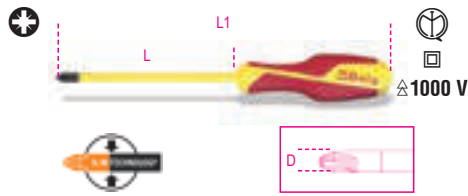

EN60900

pz	L mm	L1 mm		
1	80	187	3	012790409
2	100	218	3	012790418

1279MQ

screwdrivers for cross head Pozidriv®-Supadriv® screws



EN 60900

PZ	L mm	L1 mm		
0	60	160	3	012790703
1	80	187	3	012790709
2	100	218	3	012790718
3	150	276	2	012790724

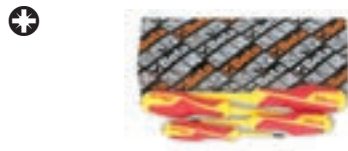

1279MQ/S4	1	012790751
PZ 0-1-2-3		

1725MQ

mini-hacksaw frame



EN 60900

1725MQ	L mm	H mm		
	260	85	1	017250030

1777MQ/C

cable stripping knife, insulated

• for multicore cables



EN 60900

1777MQ/C	L mm		
	190	1	017770026

1777MQ/U

cable stripping knife, insulated



EN 60900

1777MQ/U	L mm		
	190	1	017770011

1777RL/U

4 spare blades for utility knife 1777MQ/U



1777RL/U	1	017770021
----------	---	-----------

1995MQ/T

insulating mat

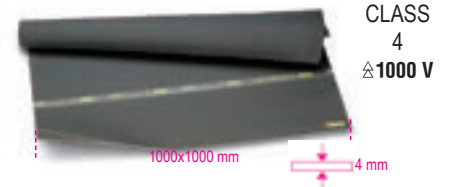

VDE 0303
EN 60243

1995MQ/T	LxSxH mm		
	1000x1000	1	019950030

1995MQ/G1 - G2

insulating gloves in latex

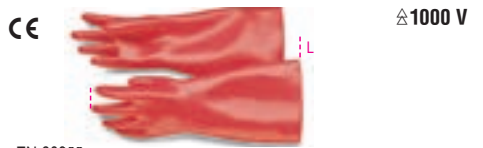

EN 60903

1995MQ/G1	Gr.	L mm		
	9	410	1	019950010
1995MQ/G2	10	410	1	019950013

Beta



TETHERED TOOLS

Beta H-SAFE

The H-SAFE tool range by Beta comprises over 200 coded items, for which a holding system has been individually designed to withstand extremely severe mechanical stress, as synonymous with unparalleled safety.

Operating comfort is also crucial: tools with a double active part, including combination wrench item 42, are tied with a cable which runs along the entire body of the tool; whereas twisting tools, including screwdrivers, are tied with freely rotating rings preventing the string from getting twisted.



The H-SAFE holding system has been designed, tested and manufactured in Beta's factories. With the H-SAFE system by Beta, tools are always within reach, comfortably and safely.

35HS

flat chisels, ribbed type

with H-SAFE tethered system



L mm	A mm		
200	23,0	1	000354004
250	28,5	1	000354005

42HS

combination wrenches, open and offset ring ends

with H-SAFE tethered system



DIN 3113 UNI-ISO 7738

mm	L mm		
6x6	95	1	000424006
7x7	105	1	000424007
8x8	116	1	000424008
9x9	127	1	000424009
10x10	137	1	000424010
11x11	148	1	000424011
12x12	158	1	000424012
13x13	169	1	000424013
14x14	180	1	000424014
15x15	190	1	000424015
16x16	201	1	000424016
17x17	212	1	000424017
18x18	222	1	000424018
19x19	233	1	000424019
20x20	243	1	000424020
21x21	254	1	000424021
22x22	264	1	000424022
23x23	275	1	000424023
24x24	285	1	000424024
25x25	296	1	000424025
26x26	307	1	000424026
27x27	317	1	000424027
28x28	328	1	000424028
29x29	338	1	000424029
30x30	349	1	000424030
32x32	370	1	000424032
34x34	391	1	000424034
36x36	412	1	000424036

42HS/AS

combination wrenches, open and offset ring ends

with H-SAFE tethered system



mm	L mm		
1/4x1/4	95	1	000424106
5/16x5/16	116	1	000424108
3/8x3/8	137	1	000424110
7/16x7/16	148	1	000424111
1/2x1/2	169	1	000424113
9/16x9/16	180	1	000424114
5/8x5/8	201	1	000424116
11/16x11/16	212	1	000424117
3/4x3/4	233	1	000424119
13/16x13/16	254	1	000424121

"	L mm		
7/8x7/8	264	1	000424122
15/16x15/16	285	1	000424124
1x1	296	1	000424125
1.1/16x1.1/16	317	1	000424127
1.1/8x1.1/8	338	1	000424129
1.1/4x1.1/4	370	1	000424132
1.5/16x1.5/16	391	1	000424133

55HS

double open end wrenches

with H-SAFE tethered system



UNI-ISO 10102 DIN 3110

mm	L mm		
• 6x7	120	1	000554012
• 8x9	140	1	000554021
• 10x11	155	1	000554030
• 12x13	170	1	000554042
• 14x15	185	1	000554054
• 16x17	202	1	000554060
• 18x19	220	1	000554066
• 20x22	236	1	000554075
• 21x23	245	1	000554078
• 22x24	245	1	000554081
• 24x27	262	1	000554090
• 30x32	297	1	000554108
• 34x36	325	1	000554117

91HS-C

heavy duty offset ring wrenches

with H-SAFE tethered system



mm	Ø mm		
36	54	1	000914036
41	62	1	000914041
46	69	1	000914046

91HS

heavy duty offset ring wrenches
with H-SAFE tethered system



mm	Ø mm		
36	54	1	000914236
41	62	1	000914241
46	69	1	000914246

92HS

tubes for item 91
with H-SAFE tethered system



L mm	91 mm	Ø mm		
610	32÷41	22	1	000924020
760	46÷55	25	1	000924030

93HS

double-ended offset ring wrench for scaffolding bolts

with H-SAFE tethered system



mm	L mm		
21x22	310	1	000934021

96THS

offset hexagon key wrenches, with high torque handles

with H-SAFE tethered system



mm	L mm	L1 mm		
2,5	153	55	1	000964935
3	153	55	1	000964936
4	179	70	1	000964938
5	200	84	1	000964940
6	221	103	1	000964941
8	255	117	1	000964943
10	285	132	1	000964945

96THS-AS

offset hexagon key wrenches,
with high torque handles
with H-SAFE tethered system



"	L mm	L1 mm	Ø mm		
5/32	200	84	6	1	000964673
3/16	200	84	6	1	000964674
7/32	221	103	7	1	000964675
1/4	236	106	8	1	000964676
5/16	255	117	10	1	000964678
3/8	285	132	12	1	000964680

97TTXHS

offset key wrenches with handles for Torx(R) head screws with H-SAFE tethered system

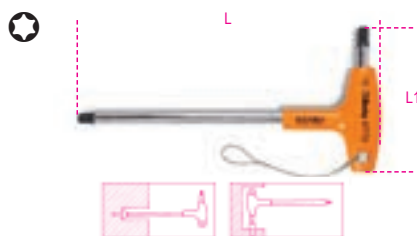

Ø	L mm	L1 mm		
T10	179	70	1	000974710
T15	179	70	1	000974715
T20	179	70	1	000974720
T25	179	70	1	000974725
T30	200	84	1	000974730
T40	221	103	1	000974740
T45	236	106	1	000974745
T50	255	117	1	000974750

111HS

adjustable wrenches with scales, chrome-plated with H-SAFE tethered system

- Right-hand rotation of pin
- With mm and inch scale



DIN 3117 ISO 6787

L mm	L* mm	A max mm	A1 mm		
200	8	28	62,0	1	001114020
250	10	34	70,0	1	001114025
300	12	35	84,0	1	001114030
380	15	45	97,0	1	001114038
450	18	54	115,0	1	001114045

142HS

reversible ratcheting combination wrenches with H-SAFE tethered system



Ø mm	L mm		
8x8	136	1	001424008
9x9	143	1	001424009
10x10	159	1	001424010
11x11	168	1	001424011
12x12	174	1	001424012
13x13	180	1	001424013
14x14	190	1	001424014
15x15	200	1	001424015
16x16	216	1	001424016
17x17	233	1	001424017
18x18	239	1	001424018
19x19	248	1	001424019
21x21	285	1	001424021
22x22	285	1	001424022
24x24	325	1	001424024
27x27	355	1	001424027
30x30	420	1	001424030
* 32x32	420	1	001424032

* Straight model without inverter

360HS

pipe wrenches, Stillson pattern with H-SAFE tethered system



L mm	Ø max* mm		
250	1" gas	1	003604025
350	1 1/2" gas	1	003604035
450	2" gas	1	003604045
600	2 1/2" gas	1	003604060

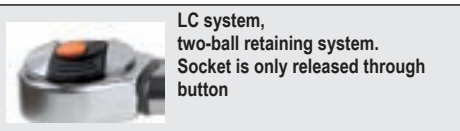

LC system, two-ball retaining system. Socket is only released through button

666HS

Click-type torque wrenches with reversible ratchets for right-hand tightening torque accuracy: ±3%

with H-SAFE tethered system



ISO 6789

Nm	Kgfm	lbf.ft	■	D mm	A mm	L mm	g
10÷50	1÷5	7÷37	3/8	30	33	312	660

666HS/5 1 006664005

Nm	Kgfm	lbf.ft	■	D mm	A mm	L mm	g
20÷100	2÷10	15÷75	3/8	30	33	381	730

666HS/10 1 006664010

Nm	Kgfm	lbf.ft	■	D mm	A mm	L mm	LC system*	g
40÷200	4÷20	30÷150	1/2	40	43	470	*	1010

666HS/20LC 1 006664021

Nm	Kgfm	lbf.ft	■	D mm	A mm	L mm	LC system*	g
60÷300	6÷30	50÷220	1/2	40	43	598	*	1380

666HS/30LC 1 006664031

900E-HS/55

reversible ratchets with H-SAFE tethered system

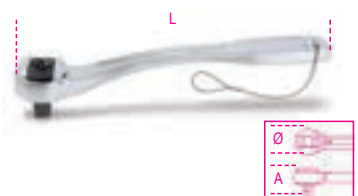

DIN 3122 - UNI-ISO 3315

L mm	Ø mm	A mm	■		
125	25	18	1/4	1	009004880

910E-HS/55

reversible ratchets with H-SAFE tethered system



DIN 3122 - UNI-ISO 3315

L mm	Ø mm	A mm	■		
200	30	33	3/8	1	009104880

920E-HS/55LC

reversible ratchets "Locking System"

with H-SAFE tethered system



DIN 3122 - UNI-ISO 3315

L mm	Ø mm	A mm	■		
275	40	43	1/2	1	009204860

932HS

double ended hexagon / bi-hex offset socket wrenches, bright chrome-plated with H-SAFE tethered system

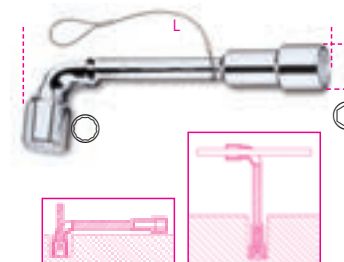

NF E 74.303

Ø mm	Ø mm	L mm		
6x6	11,5	110	1	009324006
7x7	12,5	116	1	009324007
8x8	13,0	120	1	009324008
9x9	14,0	125	1	009324009
10x10	16,5	133	1	009324010
11x11	17,5	143	1	009324011
12x12	19,0	148	1	009324012
13x13	19,5	154	1	009324013
14x14	21,5	167	1	009324014
15x15	22,5	182	1	009324015
16x16	24,5	193	1	009324016
17x17	26,0	198	1	009324017
18x18	26,5	215	1	009324018
19x19	29,0	220	1	009324019

1032HS

internal circlip pliers, straight pattern PVC-coated handles with H-SAFE tethered system



UNI 7914 DIN 5256

L	∅	∅1	A		
mm	mm	mm	mm		
140x1,3	12±25	1,3	20	1	010324014
180	19±60	1,9	21	1	010324017

1034HS

internal circlip pliers, bent pattern, 90° PVC-coated handles with H-SAFE tethered system



UNI 7914 DIN 5256

L	∅	∅1	A		
mm	mm	mm	mm		
170	19±60	1,9	21	1	010344017

1036HS

external circlip pliers, straight pattern PVC-coated handles with H-SAFE tethered system



UNI 7915 DIN 5254

L	∅	∅1	A		
mm	mm	mm	mm		
140x1,3	10±25	1,3	20	1	010364014
175	19±60	1,9	21	1	010364017

1038HS

external circlip pliers, bent pattern, 90° PVC-coated handles with H-SAFE tethered system



UNI 7915 DIN 5254

L	∅	∅1	A		
mm	mm	mm	mm		
175	19±60	-	21	1	010384017

1048BM-HS

slip joint pliers, boxed joint, bimaterial handles with H-SAFE tethered system

• new 9-position model

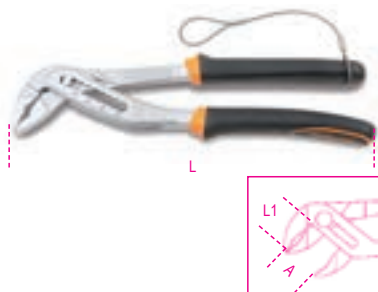

ISO 8976

L	A max	L1	g		
mm	mm	mm	g		
250	48	39	460	1	010484215

1052HS

adjustable self-locking pliers, concave jaws with H-SAFE tethered system

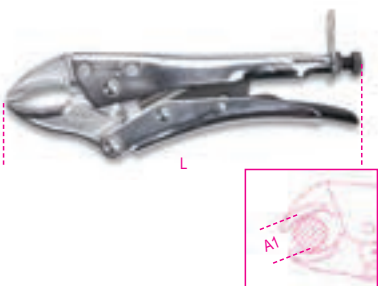

L	A	A1 max	S		
mm	mm	mm	mm		
240	72	42	10,0	1	010524024

1082BM-HS

diagonal cutting nippers, bi-material handles with H-SAFE tethered system



UNI/ISO 5749

L	L1	∅	A		
mm	mm	mm	mm		
160	22	1,6	28,0	1	010824036

1088BM-HS

heavy duty end cutting nippers, bi-material handles with H-SAFE tethered system

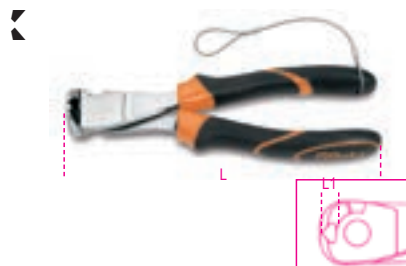

UNI/ISO 5748

L	L1	∅	A		
mm	mm	mm	mm		
160	9	1,6	28,0	1	010884036
200	11	2,0	36,0	1	010884040

1128BAX-HS

Double-acting electricians' scissors, with milling profiles in DLC-coated stainless steel with H-SAFE tethered system

Double-acting cutting: a special cam on the fulcrum allows the blades to run lengthwise, which results in increased cutting power while closing the blades.

Profile and mill: designed to enlarge holes on plastic, from 13 mm to 25 mm.

DLC coating: DLC (diamond-like carbon) is an innovative carbon-based coating: the high hardness and low coefficient of friction arise from the simultaneous presence of carbon on the surface in the form of graphite, and diamond.

- High blade surface hardness (resistance to abrasion and wear)
- Low coefficient of friction (smoothness and anti-adherence)
- Anti-loose eccentric pin
- Large handles with pipe throttling grooves
- With articulated plastic case
- Patented



L	L1	∅			
mm	mm	mm	mm²		
150	50	50		1	011284088

1132BM-HS

cable cutters for insulated copper and aluminium cables, bi-material handles with H-SAFE tethered system



UNI 8791

L	∅	A	B		
mm	mm	mm	mm		
230	18	37	12,5	1	011324143

1150BM-HS

combination pliers bright chrome-plated, bi-material handles with H-SAFE tethered system



ISO 5746

L mm	L1 mm	∅ mm	A mm		
160	37	1,6	24,0	1	011504036
180	41	1,8	28,0	1	011504038
200	45	2,0	32,0	1	011504040

1166BM-HS

extra long needle knurled nose pliers, bi-material handles with H-SAFE tethered system



ISO 5745

L mm	L1 mm	∅ mm	A mm		
200	76	1,6	22,0	1	011664040

1168BM-HS

extra long bent needle knurled nose pliers, bi-material handles



ISO 5745

L mm	L1 mm	∅ mm	A mm		
200	70	1,6	22,0	1	011684040

1290HS

screwdrivers for slotted head screws H-SAFE

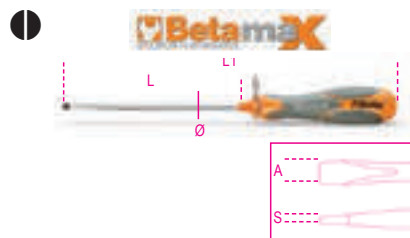

ISO 2380

SxAxL mm	L1 mm	Ø mm		
0,4x2,5x75	171	2,5	1	012904006
0,5x3x100	196	3,0	1	012904012
0,6x3,5x100	196	3,5	1	012904021
0,8x4x100	196	4,0	1	012904030
0,8x4x150	246	4,0	1	012904036
1x5,5x150	259	5,0	1	012904042
1,2x6,5x150	270	6,0	1	012904051
1,2x8x150	282	7,0	1	012904057
1,6x10x200	332	8,0	1	012904066

1292HS

screwdrivers for cross head Phillips® screws with H-SAFE tethered system

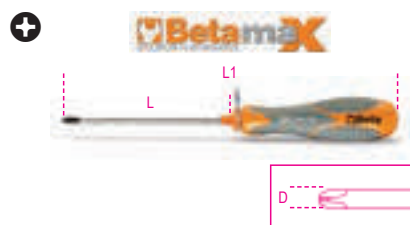

UNI/ISO 8764

PHxDxL mm	L1 mm		
0x3x100	196	1	012924006
1x4,5x120	229	1	012924012
2x6x150	270	1	012924021
3x8x150	282	1	012924024

1294HS

screwdrivers for headless slotted screws with H-SAFE tethered system

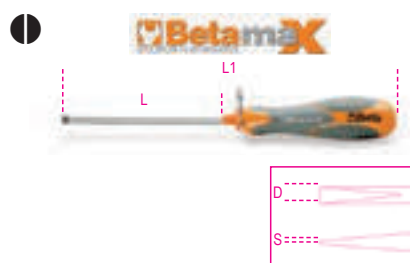

SxDxL mm	L1 mm		
0,5x2,5x60	156	1	012944003
0,6x3x75	171	1	012944006
0,8x4x100	196	1	012944012
1x5x125	234	1	012944018

1299HS

screwdrivers for cross head Pozidriv(R)-Supadriv(R) screws with H-SAFE tethered system



UNI/ISO 8764

PZ	L mm	L1 mm		
0	60	156	1	012994000
1	80	189	1	012994003
2	100	220	1	012994006
3	150	282	1	012994009

1370T-HS

mechanic's hammers fibre shaft with H-SAFE tethered system



g	A mm	L mm	L1 mm		
300	23	300	105	1	013704630
500	27	320	118	1	013704650
1000	36	360	135	1	013704700

1370FT-HS

riveting hammers, fibre shafts with H-SAFE tethered system



A mm	L mm	L1 mm	B mm		
28	280	86	22	1	013704528
30	280	92	24	1	013704530
36	300	104	29	1	013704536

1390HS

soft face hammers, wooden shafts with H-SAFE tethered system



UNI 7784

D mm	L mm	L1 mm		
35	310	95	1	013904035
45	320	107	1	013904045

Beta

1392HS

dead-blow hammers, with interchangeable plastic faces, steel shafts with H-SAFE tethered system



D mm	L mm	L1 mm	
35	305	115	1 013924035
40	310	125	1 013924040
50	325	135	1 013924050
60	385	155	1 013924060

1602A-HS

crimping pliers for insulated terminals, standard model with H-SAFE tethered system



mm ²	L mm	A mm	B mm	
0÷6	220	42	4	1 016024005

1682HS

flexible graduated rules made from stainless steel with H-SAFE tethered system

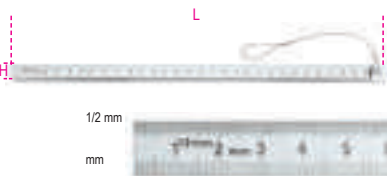

L mm	H mm	±	
200	13	0,5	1 016824020
300	13	0,5	1 016824030

1692HS

measuring tapes, shock-resistant bi-material ABS casings, steel tapes, precision class II

with H-SAFE tethered system



L m	S mm	
3	16	1 016924053
5	19	1 016924055

1708HS/20

metric feeler gauges with H-SAFE tethered system



S mm				
0,05	±1,0	0,002	±0,040	105

1727HS

hacksaw frame, heavy series with H-SAFE tethered system

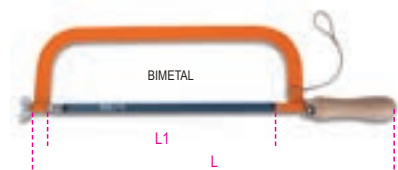

L mm	L1 mm	
515	300	1 017274001

1743HS

fitting tool for nylon ties with H-SAFE tethered system

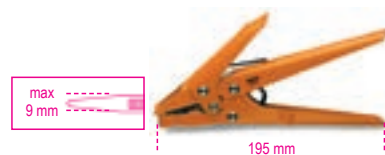

L mm	A mm	B mm	
195	85	17	1 017434001

1750HS

lever operated grease guns with H-SAFE tethered system



1 g, 550 bar Max

cc	L mm	
500	380	1 017504500

1760BHS

digital multimeter with H-SAFE tethered system



SPECIFICATIONS

DC voltage: 200 mV-2/20/200/1000V
 AC voltage: 2-20/200/700V
 DC current: 2/20/200 mA-20 A
 AC current: 2/200 mA- 20 A
 Resistance: 200Ω - 2/20/200 kΩ - 2/20 MΩ
 Capacity: 2/20/200 nF - 2/200 μF
 Temperature: -20° + 1000°C/-4 °F ~ +2000°F
 Frequency: 20kHz
 Power supply: 1 9V battery (included)

1760BHS

1 017604012

1772H-HS

safety utility knife with retractable blade, supplied with 2 blades with H-SAFE tethered system



L mm	A mm		
170	18	1	017724029

1778SOS-HS

car service knife with window breaking hammer and seat belt cutter features in case with H-SAFE tethered system



L mm	A mm	L1 mm	
205	25	85	1 017784080

8871

safety belt with metal double closure buckle. To connect H-SAFE tools



L cm			
min-max	70-100	1	088710070
	100-135	1	088710100

8872A

fixed loop

• For belt item 8871



8872A 50		1	088720050
----------	--	---	-----------

8872AS

strap loop

• For belt item 8871



8872AS 25	D mm	1	088720525
	25		

8873

tool bag with self-locking

• For belt item 8871



8873		1	088730230
------	--	---	-----------

8877

cushioned hook-up lace

• MAX 2.7 kg

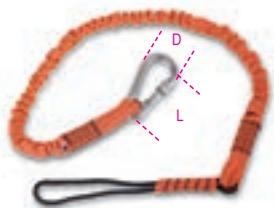

8877 80	L cm min-max	DxL mm	1	088770080
	70-110	40x80		

8877M

cushioned hook-up lace

• With anti-winding joint
• MAX 2.7 kg



8877M 20-140	L cm min-max	DxL mm	1	088770510
	20-140	30x60		

8879

strap wristband

• MAX 2.7 kg



8879	D mm	1	088790025
	30		

8880

hard hook-up lace

• With anti-winding joint



8880	L Cm	D mm	1	088800030
	30	10		

8883

tool bag

• Made of anti-abrasion nylon 840
• MAX 20 kg
• Snap link for stopping zip at top
• 6 tool retaining strings
• Interior pocket



8883	DxH cm	1	088830030
	30x40		

Beta

STAINLESS STEEL TOOLS



Stainless steel is an alloy steel with a high chromium content. Chromium forms a surface oxide film which protects metal and immediately reforms in case of chemical or mechanical damage.

We at **Beta Utensili** have relied on this unique characteristic to develop the **Beta Inox** tools, which are the name for high resistance to corrosion as well as remarkable **hygiene** and **low bacterial retentiveness**. Indeed, stainless steel tools **get less dirty and are cleaned better** than those made from other materials, and can be **autoclaved at 121 °C**.

The **Beta Inox** tools can be used in **critical environments** – that is, in areas where absolutely no contamination is permitted.

Fields of application:

- Nuclear applications
- Pharmaceutical production - class C
- Biotechnological and biomedical laboratories
- Food industry.

The **Beta Inox** tools avoid ferrous contamination, thus preventing improper **rust formation**. Whenever any tools made of ordinary carbon steel are used on stainless steel screws, nuts or surfaces, a few iron particles may come off the tools, which results in aesthetic problems (**iron moulds**). If neglected, these trigger localized corrosion. Using stainless steel tools will completely prevent polluting particles from spreading.

Fields of application:

- Shipyards
- Building
- Offshore applications
- Solar systems
- Car industry



STAINLESS STEEL
+ NO STAINLESS
STEEL = RUST



STAINLESS STEEL
+ STAINLESS
STEEL = NO RUST

Mechanical characteristics

Beta's tools are made of magnetic **steel AISI 420**. Its outstanding mechanical characteristics translate into tools whose performance far exceeds the standards and is comparable to that of Beta's other tools. These tools share the same ergonomic properties and design as Beta's other tools, which have been known to, and appreciated by, professional users for over 80 years. The containers are made of **steel AISI 304**, which can boast remarkable cold formability properties and even higher corrosion resistance.

Recyclability

Stainless steel is **100% recyclable**. This is also a major plus.



Mark for stainless steel products
Released by Centro Inox – Italian Stainless Steel
Development Association
– for products made of stainless steel.

34INOX

flat chisels,
made of stainless steel



L	A	Ø		
mm	mm	mm		
160	18	18	1	000340318
200	20	20	1	000340320

39INOX

wedges,
made of stainless steel



L	A	S		
mm	mm	mm		
100	50	10	1	000390310
150	50	13	1	000390315
200	40	40	1	000390320

42INOX

combination wrenches
made of stainless steel



DIN 3113 - UNI ISO 7738

mm	L		
mm	mm		
6x6	95	2	000420306
7x7	105	2	000420307
8x8	116	2	000420308
9x9	127	2	000420309
10x10	137	2	000420310
11x11	148	2	000420311
12x12	158	2	000420312
13x13	169	2	000420313
14x14	180	2	000420314
15x15	190	2	000420315
16x16	201	2	000420316
17x17	212	2	000420317
18x18	222	2	000420318
19x19	233	2	000420319
21x21	254	1	000420321
22x22	264	1	000420322
24x24	285	1	000420324
27x27	290	1	000420327
30x30	320	1	000420330
32x32	340	1	000420332
36x36	360	1	000420336
38x38	430	1	000420338
41x41	430	1	000420341
46x46	480	1	000420343
50x50	520	1	000420345
55x55	560	1	000420347
60x60	595	1	000420350



42INOX/S11	1	000420391
6-8-10-11-12-13-14-15-16-17-19 mm		



42INOX/SC9	1	000420387
8-10-11-12-13-14-15-17-19 mm		
42/SCV9I	1	000420103

42INOX-AS

combination wrenches,
made of stainless steel



"	L		
mm	mm		
1/4x1/4	95	1	000420356
5/16x5/16	116	1	000420358
3/8x3/8	137	1	000420360
7/16x7/16	148	1	000420361
1/2x1/2	169	1	000420363
9/16x9/16	180	1	000420364
5/8x5/8	201	1	000420366
11/16x11/16	212	1	000420367
3/4x3/4	233	1	000420369
13/16x13/16	254	1	000420371
7/8x7/8	264	1	000420372
15/16x15/16	285	1	000420373



42INOX-AS/S9	1	000420396
1/4-5/16-3/8-7/16-1/2-9/16-5/8-11/16-3/4		

96BPINOX

ball head offset hexagon key wrenches,
made of stainless steel



mm	L	L1	Ø		
mm	mm	mm	g		
2	91	22	4	4	000961441
2,5	91	22	6	4	000961442
3	101	24	11	4	000961443
4	112	29	19	4	000961444
5	131	33	32	4	000961445
6	154	36	51	4	000961446
7	164	40	65	2	000961447
8	175	44	116	2	000961448
10	197	51	189	2	000961450



96BPINOX/B6	1	000961455
2,5-3-4-5-6-8 mm		
96BPINOX/B9	1	000961456
2-2,5-3-4-5-6-7-8-10 mm		
96BPINOX/BV	1	000961459

96BPINOX-AS

ball head offset hexagon key wrenches,
made of stainless steel



"	L	L1	Ø		
mm	mm	mm	g		
5/64	91	22	5,5	4	000961989
3/32	91	22	5,3	4	000961990
7/64	101	24	10,5	4	000961991
1/8	101	24	10,7	4	000961992
9/64	112	29	18,7	4	000961993
5/32	112	29	18,7	4	000961994
3/16	131	33	31,5	2	000961995
7/32	154	36	50,0	2	000961996
1/4	164	40	70,0	2	000961997
5/16	175	44	115,0	2	000961998
3/8	197	51	186,5	2	000961999



96BPINOX-AS/B8	1	000962000
5/64-3/32-1/8-5/32-3/16-7/32-1/4-5/16		
96BPINOX/BV	1	000961459

Beta

96TINOX

offset hexagon key wrenches,
with high-torque handles,
made of stainless steel

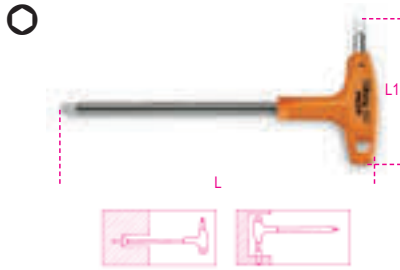

mm	L mm	L1 mm		
2,5	153	55	2	000961935
3	153	55	2	000961936
4	179	70	2	000961938
5	200	84	2	000961940
6	221	95	2	000961941
7	236	106	2	000961942
8	255	117	2	000961943
10	285	132	2	000961944



96TINOX/S5 2,5-3-4-5-6 mm	1	000961952
96TINOX/S8 2,5-3-4-5- 6-7-8-10 mm	1	000961954

96TINOX-AS

offset hexagon key wrenches,
with high torque handles,
made of stainless steel

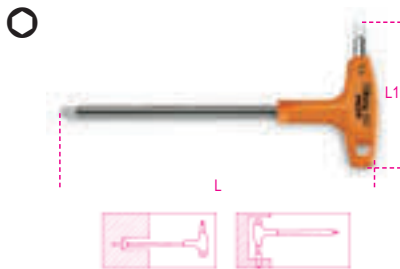

"	L mm	L1 mm	Ø mm		
3/32	153	55	3	2	000961861
7/64	153	55	4	2	000961862
1/8	179	70	4	2	000961863
9/64	179	70	5	2	000961864
5/32	200	84	6	2	000961865
3/16	200	84	6	2	000961866
7/32	221	103	7	2	000961867
1/4	236	106	8	2	000961868
5/16	255	117	10	2	000961869
3/8	285	132	12	2	000961870



96TINOX-AS/S7 3/32-1/8-5/32-3/16- 7/32-1/4-5/16	1	000961877
--	---	-----------

111INOX

adjustable wrenches,
made of stainless steel



DIN 3117 - ISO 6787

L mm	L "	A max mm	A1 mm		
150	6	18	45	1	001110315
200	8	24	58	1	001110320
250	10	30	70	1	001110325

920INOX-A

hexagon hand sockets,
made of stainless steel

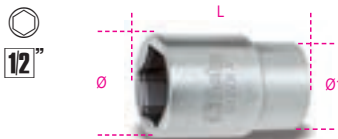

DIN 3124 - UNI ISO 2725

Ø mm	Ø "	A mm	L mm		
8	15	10	40	2	009203008
9	16	10	40	2	009203009
10	17	10	40	2	009203010
11	18	11	40	2	009203011
12	19	11	40	2	009203012
13	20	11	40	2	009203013
14	21	11	40	2	009203014
15	23	11	40	2	009203015
16	24	11	40	2	009203016
17	25	11	40	2	009203017
18	26	13	42	2	009203018
19	28	13	42	2	009203019
20	29	13	42	1	009203020
21	30	13	43	1	009203021
22	31	15	43	1	009203022
24	34	15	43	1	009203024
27	38	18	46	1	009203027
30	42	20	46	1	009203030
32	44	20	46	1	009203032

920/55INOX

1/2" drive reversible ratchet,
72 teeth,
made of stainless steel



L mm	Ø mm	A mm		
264	40	43	1	009203882

920/R55INOX



920/R55INOX	1	009203879
--------------------	---	-----------

1048INOX

slip joint pliers, boxed joints,
made of stainless steel
• 7-position model

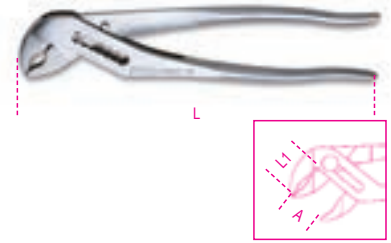

L mm	A max mm	L1 mm		
250	33	33	1	010480325

1082INOX

diagonal cutting nippers,
made of stainless steel



L mm	L1 mm	Ø mm		
150	20,0	1,6	1	010820350

1150INOX

heavy-duty combination pliers,
made of stainless steel
decentralized pin
open joint



L mm	L1 mm		
180	39	1	011500518

1153INOX

adjustable pliers, two positions,
made of stainless steel



L mm	L1 mm		
150	26	1	011530315



1290INOX

screwdrivers for slotted head screws
made of stainless steel

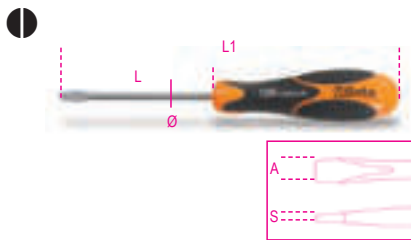

ISO 2380

SxAxL mm	L1 mm	Ø mm		
0,4x2,5x50	146	2.5	4	012900403
0,5x3x75	171	3.0	4	012900409
0,8x4x100	196	4.0	4	012900430
1,0x5,5x150	259	5.0	4	012900442
1,2x6,5x150	270	6.0	4	012900451

1292INOX

screwdrivers for cross head Phillips® screws,
made of stainless steel

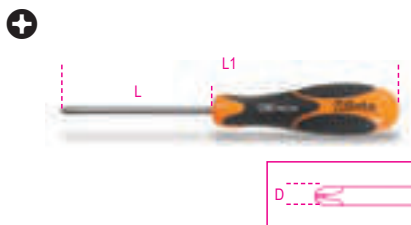

ISO 8764

PHxDxL mm	L1 mm		
0x3x60	156	4	012920403
1x4,5x80	189	4	012920409
2x6x100	220	4	012920418

1293INOX/D8

screwdriver set
made of stainless steel



1293INOX/D8

1 012930408

1290INOX	0,4x2,5x50-0,5x3x75 0,8x4x100-1,0x5,5x150- 1,2x6,5x150 mm
1292INOX	PH0x60-PH1x80 PH2x100 mm

1370INOX

engineer's hammer,
made of stainless steel



g	A mm	L mm	L1 mm		
500	25	240	101	1	013700375

1377INOX

ball pein hammers,
round heads,
for coppersmiths and tinsmiths,
made of stainless steel



g	L mm	L1 mm		
230	220	82	1	013770623
340	220	90	1	013770634

C20TSS

five-section cantilever tool box, made of AISI
304 stainless steel



C20TSS

1 021203001

≡: 450x200x210 mm - 4kg

C04TSS-7

mobile roller cab with seven drawers, made entirely of stainless steel,
Non-marking wheels

Main features:

- Seven drawers (570 x 410 mm) with ball bearing slides;
- 6 drawers, 83 mm high;
- 1 drawer, 170 mm high;
- 4 castors Ø 125 mm
- 2 fixed and 2 steering (two with brakes);
- Front centralized lock;
- Frame made entirely of stainless steel AISI 304
- Castors, supports, ball bearings, drawer interiors and guides made of stainless steel
- Drawer handles made of aluminium

63 kg



700 kg

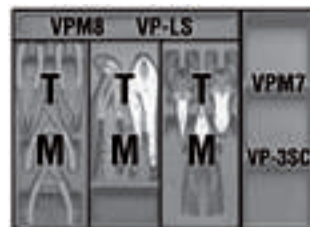

h	max
83 mm	25 kg
170 mm	30 kg

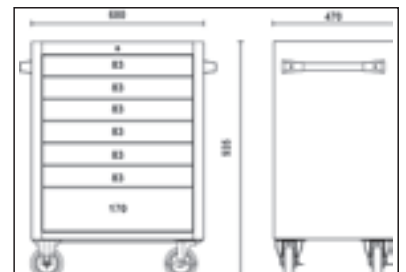



SPARK-PROOF TOOLS

Copper-Berillium Cu-Be

The **Beta** spark-proof tools are specially designed for safe operations in environments subject to potential risk of explosion, in the presence of flammable liquids or gases, or for any applications that require using perfectly antimagnetic, corrosion-resistant tools.



WARNING!
Risk of explosion in **ACETYLENE** environment

The mechanical characteristics of sparkproof tools differ from those of normal steel tools. Sparkproof tools should be used with extreme caution, avoiding overloads.

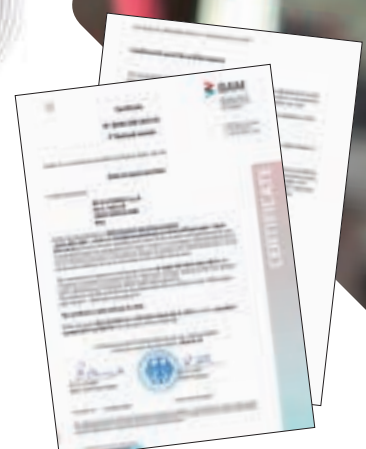

The Beta sparkproof tools are certified by the Federal Institute for Materials Research and Testing, BAM, under European Directive 99/92/EC.

CLASSIFICATION OF AREAS SUBJECT TO EXPLOSION RISK		
ATEX	MEDIUM-LOW	EXTREMELY LOW
GASES	ZONE 1 An area in which an explosive atmosphere consisting of a mixture of air and flammable substances in the form of gas, vapour or mist is likely to occur in normal operation.	ZONE 2 An area in which an explosive atmosphere consisting of a mixture of air and flammable substances in the form of gas, vapour or mist is not likely to occur in normal operation but, if it does occur, will persist for a short period only.
	ZONE 21 An area in which an explosive atmosphere in the form of a cloud of combustible dust in air is likely to occur in normal operation occasionally.	ZONE 22 An area in which an explosive atmosphere in the form of a cloud of combustible dust in air is not likely to occur in normal operation but, if it does occur, will persist for a short period only.
DUSTS		

30BA

sparkproof drift punches



Ø mm	L mm	S mm		
5	150	15	1	000300806
8	150	17	1	000300808
10	150	19	1	000300810

31BA

sparkproof pin punches



Ø mm	L mm		
3	110	1	000310853
4	110	1	000310854
6	115	1	000310856
8	120	1	000310858

31BA/C

sparkproof drift punches



Ø mm	Ø1 mm	L mm		
*6	12	150	1	000310876
*7	13	150	1	000310877
*12	18	175	1	000310882
*13	29	255	1	000310883

32BA

sparkproof centre punch



Ø mm	L mm		
14	150	1	000320811

34BA

sparkproof flat chisels



L mm	A mm		
200	22	1	000340801
250	24	1	000340803
300	25	1	000340802

39BA

sparkproof wedges



L mm	A mm		
150	40	1	000390801
230	40	1	000390802
250	40	1	000390803

42BA

sparkproof combination wrenches, open bi-hex ring ends



Ø mm	L mm		
6x6	105	1	000420806
7x7	105	1	000420807
8x8	120	1	000420808
9x9	120	1	000420809
10x10	135	1	000420810
11x11	135	1	000420811
12x12	150	1	000420812
13x13	150	1	000420813
14x14	175	1	000420814
15x15	175	1	000420815
16x16	195	1	000420816
17x17	200	1	000420817
18x18	215	1	000420818
19x19	220	1	000420819
20x20	230	1	000420820
21x21	240	1	000420821
22x22	250	1	000420822
24x24	268	1	000420824
26x26	290	1	000420826
27x27	290	1	000420827
28x28	290	1	000420828
30x30	313	1	000420830
32x32	333	1	000420832
34x34	360	1	000420834
35x35	360	1	000420835
36x36	355	1	000420836
38x38	430	1	000420838
41x41	430	1	000420841
46x46	480	1	000420846
50x50	520	1	000420850
55x55	560	1	000420855
60x60	580	1	000420860
*65x65	595	1	000420865
*70x70	630	1	000420870

42BA-AS

sparkproof combination wrenches, open bi-hex ring ends



Ø mm	L mm		
9/32x9/32	120	1	000420946
5/16x5/16	120	1	000420947
11/32x11/32	135	1	000420948
3/8x3/8	128	1	000420950
7/16x7/16	135	1	000420951
15/32x15/32	140	1	000420949
1/2x1/2	140	1	000420953
9/16x9/16	163	1	000420954
*19/32x19/32	195	1	000420955
5/8x5/8	177	1	000420956
11/16x11/16	195	1	000420957
3/4x3/4	215	1	000420959
13/16x13/16	230	1	000420961
7/8x7/8	235	1	000420962
15/16x15/16	256	1	000420964
*31/32x31/32	265	1	000420963
1x1	266	1	000420965
1.1/16x1.1/16	283	1	000420967
1.1/8x1.1/8	297	1	000420969
1.3/16x1.3/16	308	1	000420970
1.1/4x1.1/4	324	1	000420973
*1.7/16x1.7/16	360	1	000420976

55BA

sparkproof double open end wrenches



Ø mm	L mm		
6x7	90	1	000550801
8x9	100	1	000550802
8x10	100	1	000550795
9x11	110	1	000550797
10x11	120	1	000550803
12x13	130	1	000550804
*12x14	130	1	000550846
13x14	133	1	000550799
14x15	145	1	000550805
14x17	150	1	000550806
16x17	165	1	000550807
17x19	170	1	000550847
18x19	170	1	000550809
*19x22	185	1	000550810
20x22	185	1	000550811
21x23	210	1	000550813
22x24	210	1	000550815
24x26	230	1	000550817
24x27	230	1	000550818
25x28	230	1	000550819
27x29	246	1	000550820
30x32	265	1	000550822
36x38	320	1	000550826
36x41	335	1	000550828
41x46	355	1	000550829
*46x50	370	1	000550830
*50x55	385	1	000550831
*55x60	415	1	000550832

55BA-AS

sparkproof double open end wrenches



"	L mm		
3/8x7/16	110	1	000550853
1/2x9/16	130	1	000550854
5/8x11/16	160	1	000550857
3/4x13/16	180	1	000550859
7/8x15/16	210	1	000550865
1x1.1/16	230	1	000550868
1.1/8x1.3/16	245	1	000550870
1.1/4x1.5/16	255	1	000550872

58BA

sparkproof open end slogging wrenches



"	L mm		
17	125	1	000580817
19	125	1	000580819
22	135	1	000580822
24	150	1	000580824
27	165	1	000580827
30	180	1	000580830
32	190	1	000580832
*34	200	1	000580834
36	210	1	000580836
38	220	1	000580838
41	230	1	000580841
46	240	1	000580846
50	255	1	000580850
*55	305	1	000580855
*60	315	1	000580860
*65	335	1	000580865
*70	370	1	000580870
*75	375	1	000580875
*80	400	1	000580880
*85	400	1	000580885
*90	445	1	000580890
*95	445	1	000580895
*100	485	1	000580900
*110	513	1	000580901

58BA-AS



"	L mm	A mm	S mm		
*11/16	125	40,5	11,0	1	000580904
*3/4	125	40,5	11,0	1	000580905
*7/8	135	46,2	12,0	1	000580906
*15/16	150	50,3	12,0	1	000580907
*31/32	150	50,3	12,0	1	000580954
*1	175	56,9	15,0	1	000580908
*1.1/8	190	64,0	15,5	1	000580909
*1.1/4	190	64,0	15,5	1	000580910
*1.7/16	210	75,0	18,5	1	000580912
*1.1/2	220	82,0	18,5	1	000580913
*1.5/8	230	86,8	18,5	1	000580914
*1.3/4	250	98,0	20,	1	000580970

78BA

sparkproof bi-hex ring slogging wrenches



"	L mm		
17	145	1	000780817
19	145	1	000780819
22	165	1	000780822
24	140	1	000780824
27	155	1	000780827
30	165	1	000780830
32	180	1	000780832
34	192	1	000780834
36	208	1	000780836
38	215	1	000780838
41	225	1	000780841
46	245	1	000780846
50	250	1	000780850
55	265	1	000780855
60	275	1	000780860
65	295	1	000780865
70	310	1	000780870
75	325	1	000780875
80	340	1	000780880
*85	355	1	000780885
*90	380	1	000780890
*95	390	1	000780895
*100	410	1	000780900
*105	420	1	000780903
*110	445	1	000780901
*120	480	1	000780902

78BA-AS

sparkproof bi-hex ring slogging wrenches



"	L mm		
11/16	145	1	000780908
3/4	145	1	000780909
7/8	155	1	000780935
15/16	165	1	000780936
*31/32	165	1	000780937
1	175	1	000780938
*1.1/16	175	1	000780939
1.1/8	180	1	000780940
1.3/16	185	1	000780941
1.1/4	177	1	000780910
*1.5/16	200	1	000780954
*1.3/8	205	1	000780911
1.7/16	208	1	000780912
*1.1/2	215	1	000780913
*1.9/16	225	1	000780947
*1.11/16	225	1	000780962
1.5/8	225	1	000780914
*1.3/4	235	1	000780963
1.13/16	243	1	000780916
1.7/8	235	1	000780915
2	254	1	000780918
2.3/16	264	1	000780920
2.3/8	275	1	000780922
*2.9/16	286	1	000780924
*2.15/16	311	1	000780926
*3.1/8	325	1	000780928
*3.1/2	355	1	000780930

89BA

spark-proof single ring wrenches



"	L mm		
10	200	1	000890810
11	210	1	000890811
12	220	1	000890812
13	230	1	000890813
14	240	1	000890814
16	260	1	000890816
17	270	1	000890817
18	280	1	000890818
19	300	1	000890819
20	310	1	000890820
22	330	1	000890822
24	350	1	000890824
27	370	1	000890827
30	400	1	000890830
32	420	1	000890832

90BA

sparkproof double ended offset ring wrenches



"	L mm		
6x7	122	1	000900801
8x9	128	1	000900802
10x11	155	1	000900803
12x13	175	1	000900806
14x15	200	1	000900808
14x17	220	1	000900809
16x17	230	1	000900811
16x18	235	1	000900812
18x19	265	1	000900815
20x22	295	1	000900818
21x23	298	1	000900820
22x24	315	1	000900821
24x26	333	1	000900822
24x27	340	1	000900823
30x32	395	1	000900824
34x36	410	1	000900826
*36x41	450	1	000900828
*41x46	470	1	000900829
*46x50	490	1	000900830

91BA

sparkproof heavy duty offset ring wrenches



"	Ø mm		
24	38	1	000910824
27	42	1	000910827
30	48	1	000910830
32	49	1	000910832
36	54	1	000910836
41	62	1	000910841
*46	69	1	000910846
*50	75	1	000910850
*55	82	1	000910855

92BA

sparkproof tubes for item 91BA



	L	91BA	Ø		
	mm	mm	mm		
92BA/1	460	24÷30	25	1	000920810
92BA/2	610	32÷41	28	1	000920820
★92BA/3	760	46÷55	32	1	000920830

93BA

ratcheting double-ended offset ring wrench for scaffolding bolts, sparkproof



Ø	L		
mm	mm		
21x22	345	1	000930821

95BA

double ended flat ring wrenches, sparkproof



Ø	L		
mm	mm		
7x9	115	1	000950801
8x10	115	1	000950802
10x11	140	1	000950804
10x12	140	1	000950805
12x14	145	1	000950806
14x17	165	1	000950807
★16x18	170	1	000950809
★17x19	185	1	000950808
★18x19	185	1	000950810
★19x22	200	1	000950812
★21x23	230	1	000950815
★24x27	255	1	000950817
★30x32	295	1	000950820

96BA

sparkproof offset hexagon key wrenches

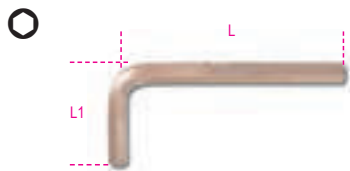

Ø	L	L1		
mm	mm	mm		
1,5	50	17	1	000960760
2	50	16	1	000960762
2,5	56	20	1	000960761
3	63	21	1	000960763
4	69	25	1	000960764
5	78	29	1	000960765
6	88	33	1	000960766
7	93	34	1	000960767
8	97	36	1	000960768
9	104	37	1	000960769
10	110	39	1	000960770
12	122	44	1	000960772

96BA/BP

ball head offset hexagon key wrenches, sparkproof

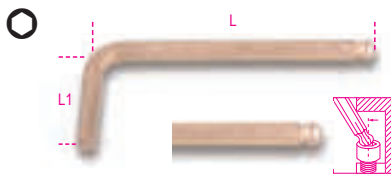

Ø	L	L1		
mm	mm	mm		
1,5	50	16	1	000961800
2	50	16	1	000961801
2,5	63	20	1	000961802
3	60	20	1	000961803
3,5	70	25	1	000961799
4	66	25	1	000961804
5	75	28	1	000961805
6	84	32	1	000961806
8	92	36	1	000961808
10	102	40	1	000961810
12	113	45	1	000961812

96BAF-AS

sparkproof offset hexagon key wrenches



Ø	L	L1		
mm	mm	mm		
★1/16	59	25	1	000962831
★5/64	59	25	1	000962832
★3/32	59	25	1	000962833
★7/64	59	25	1	000962834
★1/8	59	25	1	000962835
★9/64	64	29	1	000962836
★5/32	65	30	1	000962837
★3/16	79	31	1	000962838
★7/32	85	37	1	000962839
★1/4	85	37	1	000962840
★5/16	92	44	1	000962842
★3/8	110	45	1	000962844
★7/16	119	48	1	000962845
★1/2	140	55	1	000962846

99BA

sparkproof hook wrenches with square noses, for ring nuts UNI/ISO 2982, 2983



Ø	A		
mm	mm		
32-75	4,0	1	000990803
50-120	4,5	1	000990805
115-170	4,5	1	000990811

110BA

sparkproof adjustable wrenches



L	A		
mm	max		
100	13	1	001100810
150	18	1	001100815
200	24	1	001100820
250	30	1	001100825
300	36	1	001100830
375	46	1	001100837
★450	55	1	001100845
★600	65	1	001100860

330BA

sparkproof pipe cutters for gas pipes



	Ø	L		
	max	mm		
330BA/2	50 mm 2"	375	1	003300802

330BA/2R

spare pin and knife for gas pipe cutter 330BA, sparkproof



330BA /2-R	1	003300822
------------	---	-----------

363BA

sparkproof heavy duty pipe wrenches



L	Ø	Ø		
mm	max	max mm		
150	1/2" gas	20	1	003630815
200	1" gas	30	1	003630820
250	1 1/2" gas	49	1	003630825
300	2" gas	60	1	003630830
350	2" gas	60	1	003630835
450	2 1/2" gas	76	1	003630845
600	3" gas	90	1	003630860

378BA

sparkproof pipe wrench, Swedish pattern, made from copper/beryllium alloy



L	Ø		
mm	max "		
430	1 1/2" gas	1	003780800
530	2" gas	1	003780801

386BA

sparkproof heavy duty reversible chain pipe wrenches

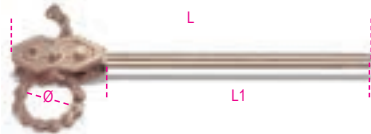

L mm	Ø max mm	L1 mm		
600	100	470	1	003860806
900	200	750	1	003860809

921BA

sparkproof bi-hex sockets

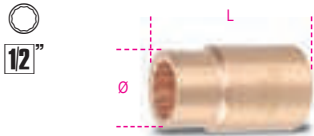

Ø mm	Ø mm	L mm		
8	24,0	40	1	009210808
9	24,0	40	1	009210809
10	16,5	40	1	009210810
11	17,5	40	1	009210811
12	18,5	40	1	009210812
13	19,5	40	1	009210813
14	20,0	40	1	009210814
15	21,5	40	1	009210815
16	24,0	40	1	009210816
17	25,0	40	1	009210817
18	25,0	40	1	009210818
19	28,0	42	1	009210819
20	29,0	42	1	009210820
21	30,0	43	1	009210821
22	30,5	43	1	009210822
24	34,0	43	1	009210824
25	36,0	43	1	009210825
26	37,5	43	1	009210826
27	37,5	45	1	009210827
28	38,9	46	1	009210828
30	41,5	46	1	009210830
32	43,5	46	1	009210832

921BA-AS

sparkproof bi-hex sockets

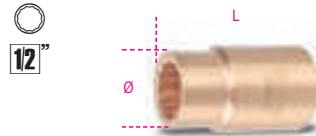

Ø mm	Ø mm	L mm		
5/16	24,0	40	1	009210958
3/8	24,0	40	1	009210960
7/16	24,0	40	1	009210961
1/2	24,0	40	1	009210963
9/16	24,0	40	1	009210964
5/8	25,0	40	1	009210966
11/16	25,5	40	1	009210967
3/4	28,0	42	1	009210969
13/16	30,0	43	1	009210971
7/8	31,5	43	1	009210972
15/16	34,0	43	1	009210974
1	36,0	43	1	009210975
1.1/16	38,0	46	1	009210977
1.1/4	42,0	46	1	009210982
1.7/16	50,5	50	1	009210986

921BA/21 - 921BA/22

sparkproof 1/2" wobble extension bars



	L mm	Ø mm		
921BA/21	125	30	1	009210842
921BA/22	250	31	1	009210844

921BA/25

sparkproof 1/2" drive universal joint



L mm	Ø mm				
80	25	1/2	1/2	1	009210845

921BA/42

sparkproof 1/2" drive sliding T handle



L mm		
250	1	009210846

921BA/50

sparkproof 1/2" drive push-through square ratchet



L mm	D mm	A mm		
250	45	16,5	1	009210850

921BA/R50

sparkproof spare set



L mm		
1/2"	1	009210851

926BA

sparkproof bi-hex hand sockets

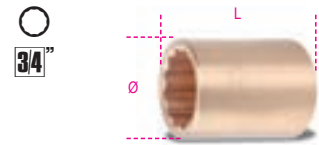

Ø mm	Ø mm	L mm		
22	40	55	1	009260822
24	40	55	1	009260824
26	40	55	1	009260826
27	40	55	1	009260827
28	41	55	1	009260828
30	43	60	1	009260830
32	45	60	1	009260832
34	48	60	1	009260834
36	50	60	1	009260836
38	53	60	1	009260838
41	57	65	1	009260841
46	63	65	1	009260846
50	68	70	1	009260850

926BA/22

sparkproof 3/4" drive extension bars



926BA/22	L mm	Ø mm		
	200	38	1	009260872

926BA/42

sparkproof 3/4" drive slide T-handle



L mm		
400	1	009260876



926BA/50

sparkproof 3/4" push-through drive ratchet



L mm	D mm	A mm	
300	61	22	1 009260880

926BA/R50

sparkproof
spare set



3/4"	
	1 009260881

937BA

hexagon socket wrenches, sparkproof



mm	L mm	A mm	
13	240	45	1 009370813
17	260	51	1 009370817
19	270	55	1 009370819
22	278	59	1 009370822
24	286	63	1 009370824
27	294	69	1 009370827
30	302	75	1 009370830
32	310	81	1 009370832
★36	330	85	1 009370836
★41	350	90	1 009370841

951BA

T-handle wrenches with hexagon male ends,
sparkproof

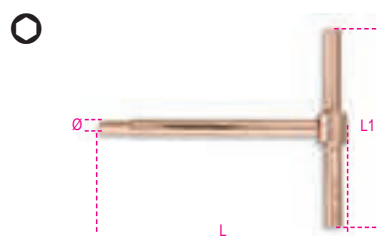

mm	L mm	L1 mm	
4	100	90	1 009510904
5	100	90	1 009510905
6	100	90	1 009510906

961BA

sparkproof scrapers



L mm	A mm	
250	39	1 009610802
350	55	1 009610806

963BA

sparkproof pry bars with pointed and flat bent
ends



L mm	A mm	
500	24	1 009630801
★800	24	1 009630803
★1000	30	1 009630805

964BA

sparkproof wrench bungs



L mm	
385	1 009640801

964BA/L

universal shears for barrels,
sparkproof

For opening edged metal barrels

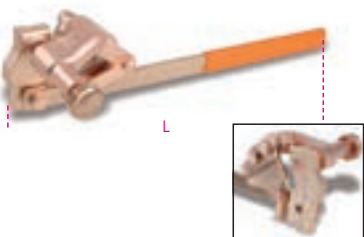

★964BA/L	L mm	
	510	1 009640821

965BA

safety valve wrenches, sparkproof



A mm	A1 mm	L mm	
30	44	200	1 009650830
32	50	300	1 009650832
35	47	250	1 009650835
40	50	300	1 009650840
45	58	350	1 009650845
48	62	375	1 009650848
50	67	400	1 009650850
55	73	450	1 009650855
60	79	500	1 009650860
★65	82	550	1 009650865
★70	85	600	1 009650870

966BA

sparkproof safety valve wrench



L mm	L1 mm	Ø min+max mm	
350	40	50+150	1 009660801

966BA/V

sparkproof safety valve wrenches

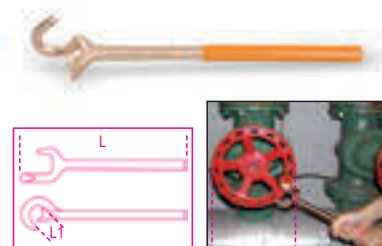

L mm	L1 mm	Ø min+max mm	
370	36	125+250	1 009660812
430	48	250+400	1 009660814

1032BA

sparkproof internal circlip pliers, straight
pattern,
PVC-coated handles



L mm	Ø mm	
200	40=100	1 010320820

1036BA

sparkproof external circlip pliers, straight
pattern,
PVC-coated handles



L mm	Ø mm	
200	40=100	1 010360820

1046BA

sparkproof slip joint pliers

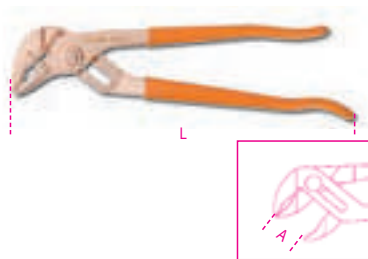

L mm	A max mm		
250	32	1	010460801
★300	52	1	010460803

1052BA

adjustable self-locking pliers,
concave jaws, sparkproof

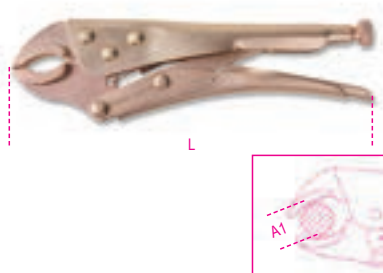

L mm	A1 max mm		
225	40,0	1	010520824

1082BA

sparkproof diagonal cutting nippers



L mm	L1 mm		
160	22	1	010820801

1137BA

blasting pliers



L mm	L1 mm		
185	30	1	011370801

1137BA/RC

spare blade for item 1137BA



1137BA/RC	1	011370851
-----------	---	-----------

1150BA

sparkproof combination pliers



L mm	L1 mm		
200	40	1	011500820

1162BA

sparkproof extra-long flat knurled nose pliers

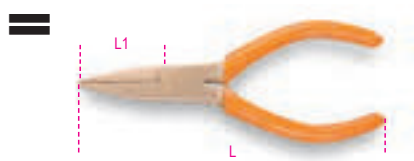

L mm	L1 mm		
150	54	1	011620815

1166BA

sparkproof extra-long needle knurled nose pliers



L mm	L1 mm		
150	54	1	011660815

1270BA

sparkproof screwdrivers for slotted head screws



AxL mm	L1 mm		
3x75	178	1	012700803
4x100	209	1	012700804
5x150	250	1	012700805
6x150	270	1	012700806
10x250	382	1	012700810
8x200	312	1	012700808

1272BA

sparkproof screwdrivers for cross head Phillips® screws



PHxDxL mm	L1 mm		
1x5x100	209	1	012720801
2x6x150	270	1	012720802
3x8x200	332	1	012720803

1277BA

screwdrivers for Torx® head screws,
sparkproof



Ø	L mm	L1 mm	Ø mm		
T10	75	184	5	1	012770810
T15	75	184	5	1	012770815
T20	100	209	6	1	012770820
T25	125	209	6	1	012770825
T30	150	270	6	1	012770830
T40	200	332	8	1	012770840

1370BA

sparkproof engineer's hammers,
wooden shafts



g	A mm	L mm	L1 mm		
500	30	310	108	1	013700805
1000	35	340	137	1	013700810

1370BA/MR

spare shafts for item 1370BA

1370BA/MR 500	1	013700865
1370BA/500		
1370BA/MR 1000	1	013700870
1370BA/1000		

1370BA/PL

sparkproof engineer's hammers,
fibre shafts



g	A mm	L mm	L1 mm		
500	30	310	108	1	013700815
1000	35	340	137	1	013700820

1375BA/PL

sparkproof ball pein and claw hammer, wooden shaft



g	L mm	L1 mm	Ø mm	
680	321	125	30	1 013750800

1377BA

sparkproof ball pein hammer, round head, for coppersmiths and tinsmiths



g	L1 mm	L mm	
340	90	280	1 013770834

1377BA/PL

sparkproof ball pein hammer, round head, for coppersmiths and tinsmiths



g	L1 mm	L mm	
340	90	280	1 013770884

1379BA

sparkproof scraping hammer, wooden shaft



g	L1 mm	L mm	
500	142	315	1 013790850

1380BA

sparkproof lump hammers, wooden shafts



g	L1 mm	L mm	
1000	100	400	1 013800810
1500	118	400	1 013800815
2000	126	400	1 013800820

1380BA/MR

spare shafts for item 1380BA

1380BA/MR 1000 1380BA/1000	1 013800860
1380BA/MR 1500 1380BA/1500	1 013800865
1380BA/MR 2000 1380BA/2000	1 013800870

1380BA/PL

sparkproof mason club hammers, fibre shafts



g	L1 mm	L mm	
500	80	310	1 013800955
1000	94	350	1 013800960
1500	115	400	1 013800965
2000	125,5	400	1 013800970

1381BA

sparkproof sledge hammers, wooden shafts



g	L1 mm	L mm	
5000	179	900	1 013810850
★8000	190	900	1 013810858

1381BA/MR

spare shaft for item 1381BA

1381BA/MR 5000 1381BA/5000	1 013810870
★1381BA/MR 8000 1381BA/8000	1 013810878

1381BA/PL

sparkproof sledge hammers, fibre shafts



g	L1 mm	L mm	
5000	172	900	1 013810885
8000	204	900	1 013810888

1390BA

spark-proof soft face hammer



Ø mm	L mm	L1 mm	
★52	370	130	1 013900805

1390BA/R

spare nylon faces for item 1390BA



D mm	
52	4 013900885

1602BA

sparkproof crimping pliers for insulated terminals, lightweight series



0.75 ± 6	L mm 200		
		1	016020801

1701BA

sparkproof hexagon chisels



L mm	A mm	S mm		
150	12	10	1	017010810
200	16	14	1	017010814
250	18	14	1	017010815
350	19	17	1	017010817

1703BA/A

sparkproof axe



L mm 340	L1 mm 145	A mm 82		
			1	017030082

1703BA/P

sparkproof pick



A mm 56	L mm 1050	L1 mm 410		
			1	017030150

1703BA/PL

sparkproof shovel



A mm 240	L1 mm 420	L mm 990		
			1	017030200

1717BA

sparkproof rigid spatulas



A mm 60		
80	1	017170801
	1	017170803

1717BA/1

sparkproof wall scraper



A mm 100	L mm 220		
		1	017170805

1719BA8

sparkproof files, 8"



	L mm 200		
1719BA8/P	200	1	017190801
1719BA8/M	200	1	017190805
1719BA8/R	200	1	017190810
1719BA8/T	200	1	017190815
1719BA8/Q	200	1	017190820

1719BA12

sparkproof files, 12"



1719BA12/P	L mm 300		
		1	017190831

1727BA

sparkproof hacksaw and blade

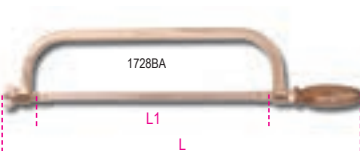

L mm 500	L1 mm 300		
		1	017270801

1728BA

spark-proof blades for hacksaw frames, made from copper-beryllium alloy



L mm 300		
	1	017280801

1737BA

brush with sparkproof wires



L mm 294	A mm 29		
		1	017370801

1758BA

sparkproof funnel



Ø mm 160	H mm 150		
		1	017580815

1776BA

sparkproof knife



L1 mm 145	L mm 250		
		1	017760801

1784BA

sparkproof scissors



L mm 225		
	1	017840822



1972/12

ultracompact drill, 12V

- ultracompact, no more than 176 mm in length; ultralightweight, no more than 1.1 kg, with battery, perfectly balanced
- double mechanical speed with steel gears and 18-position clutch
- torque up to 34 Nm and 1500 rpm (350 rpm in 1st gear); drills diameters up to 10 mm in steel and 20 mm in wood
- 2Ah batteries and charge indicator on drill body
- triple battery self-protection (heat, overload and monitoring of charge differences (if any) between cells) for increased safety and durable high performance
- ergonomic nonslip handle
- front LED
- 10-mm autochuck
- belt clip (right/left side)
- selector switch, screwing-unscrewing-locking modes (for transportation)
- supplied in a hard case with 2 lithium ion batteries (2 Ah) and quick charger (45 min)

📏 1,1 kg

1972/12

1 019720012



1972/18

percussion drill, 18 V, brushless -ultracompact-

- digital brushless motor: remarkably enhanced performance, including: increased power, reduced energy consumption, extended useful motor life, outstanding compactness, improved power proportioning from push button.
- torque up to 75 Nm and 2100 rpm (550 rpm in 1st gear); drills diameters up to 13 mm in steel and 45 mm in wood
 - ultracompact: no more than 192 mm in length
 - 13-mm steel chuck with free ring nut on tip, in order not to damage surfaces in case of friction
 - double mechanical speed with steel gears and selector switch for drilling, percussion drilling and screwing operations, with 20-position clutch
 - gearcase made entirely from metal, for increased sturdiness and durability
 - 5Ah batteries with charge indicator
 - triple battery self-protection (heat, overload and management of charge differences (if any) between cells) for increased safety and durable high performance
 - belt clip (right/left side)
 - front LED
 - with side handle for high torque use
 - selector switch, screwing-unscrewing-locking modes (for transportation)
 - ergonomic nonslip handle
 - supplied in a hard case with 2 lithium ion batteries (5 Ah) and quick charger (80 min)

📏 2,2 kg

1972/18

1 019720018



1982/12EF

reversible impact wrench, 12V

ideal for jobs in small areas, provides high torque (115 Nm), one-handed operation

- 0-2,000 rpm / 0-3,000 rpm
- 2Ah batteries with charge indicator on wrench body
- ultracompact: no more than 163 mm in length; ultralightweight: no more than 1.1 kg, with battery, perfectly balanced
- 1/4" hexagon drive with locknut
- belt clip (right/left side)
- triple front LED
- selector switch, screwing-unscrewing-locking modes (for transportation)
- ergonomic nonslip handle
- gearcase made entirely of metal
- triple battery self-protection (heat, overload and monitoring of charge differences (if any) between cells) for increased safety and durable high performance
- supplied in a hard case with 2 lithium ion batteries (2 Ah) and quick charger (45 min)

1.1 kg



1982/12EF

1 019820012

1984/18QM

reversible impact wrench, 18V, brushless

digital brushless motor: remarkably enhanced performance, including: increased power, reduced energy consumption, extended useful motor life, outstanding compactness, improved power proportioning from push button.

- 5Ah batteries with charge indicator
- ultracompact: no more than 196 mm in length
- 1/2" male drive with bush retaining ring
- belt clip (right/left side)
- triple front LED
- gearcase made entirely of metal
- selector switch, screwing-unscrewing-locking modes (for transportation)
- ergonomic nonslip handle
- triple battery self-protection (heat, overload and monitoring of charge differences (if any) between cells) for increased safety and durable high performance

4 modes available:

1: 270Nm; 1400 RPM

2: 360Nm; 2000 RPM

3: 450Nm; 2750 RPM

A: 450Nm Autostop - as long as the impact wrench detects a free rotation, it applies maximum torque/speed (450Nm; 2750 RPM) when the nut reaches the end of stroke and stops rotating, the impact wrench keeps applying maximum torque for 1 second; then it sets itself to the lowest level, to avoid damaging the nut

- supplied in a hard case with hexagon bit holder adaptor (1/4"), 2 lithium ion batteries (5 Ah) and quick charger (80 min)

2.3 kg



1984/18QM

1 019840018



PNEUMATIC TOOLS

For over 20 years Beta Utensili has supplemented its products with a comprehensive range of pneumatic tools and accessories developed for the automotive and industrial maintenance markets: impact wrenches, ratchets, drills, grinders, sanders and many more items.

During this period close co-operation with professional users has been key to ongoing growth. It is on the basis of such growth that Beta's pneumatic tools can boast an excellent reliability/performance ratio. In order to satisfy market requirements in the best possible way, Beta Utensili repairs the pneumatic tools in its Quality Department. This process has allowed the company to improve its know-how to a significant extent and become increasingly responsive to the customer base.



www.beta-tools.com

1921B1

baby reversible air ratchet

1/4"

CE



Free speed	350 rpm
Max. torque	24 Nm
Bolt capacity	Cl 8.8 M7 ● 11 mm
Bolt capacity	Cl 12.9 M6 ● 10 mm
Air inlet	1/4" GAS
Working pressure	6,2 bar
Internal hose size (Ø)	8 mm
Mean air consumption	68 l/min
Weight	0,4 kg

1/4	kg	1	019210001
-----	----	---	-----------

1921N3

reversible ratchet

1/2"

CE



Free speed	150 rpm
Max. torque	68 Nm
Bolt capacity	Cl 8.8 M10 ● 16 mm
Bolt capacity	Cl 12.9 M8 ● 13 mm
Air inlet	1/4" GAS
Working pressure	6,2 bar
Internal hose size (Ø)	10 mm
Mean air consumption	140 l/min
Weight	1,2 kg

1/2	kg	1,2	1	019210025
-----	----	-----	---	-----------

1922P3

reversible air impact ratchet

1/2"

CE



Free speed	600 rpm
Maximum torque	136 Nm
Bolt capacity	Cl 8.8 M12 ● 18 mm
Bolt capacity	Cl 12.9 M10 ● 16 mm
Air inlet	1/4" GAS
Working pressure	6,2 bar
Internal hose size (Ø)	10 mm
Mean air consumption	113 l/min
Weight	1,5 kg

1/2	kg	1,5	1	019220013
-----	----	-----	---	-----------

1921M1

compact reversible air ratchet

1/4"

CE



Free speed	200 rpm
Max. torque	27 Nm
Bolt capacity	Cl 8.8 M7 ● 11 mm
Bolt capacity	Cl 12.9 M6 ● 10 mm
Air inlet	1/4" GAS
Working pressure	6,2 bar
Internal hose size (Ø)	8 mm
Mean air consumption	96 l/min
Weight	0,6 kg

1/4	kg	0,6	1	019210005
-----	----	-----	---	-----------

1922P1

reversible air impact ratchet

1/4"

CE



Free speed	700 rpm
Maximum torque	68 Nm
Bolt capacity	Cl 8.8 M10 ● 16 mm
Bolt capacity	Cl 12.9 M8 ● 13 mm
Air inlet	1/4" GAS
Working pressure	6,2 bar
Internal hose size (Ø)	10 mm
Mean air consumption	88 l/min
Weight	0,6 kg

1/4	kg	0,6	1	019220006
-----	----	-----	---	-----------

1924F

butterfly compact reversible impact wrench

3/8"

CE



Free speed	12,000 rpm
Maximum torque	108 Nm
Bolt capacity	Cl 8.8 M12 ● 18 mm
Bolt capacity	Cl 12.9 M10 ● 16 mm
Air inlet	1/4" GAS
Working pressure	6,2 bar
Internal hose size (Ø)	10 mm
Mean air consumption	59 l/min
Weight	0,5 kg

3/8	kg	0,5	1	019240025
-----	----	-----	---	-----------

1921M2

compact reversible air ratchet

3/8"

CE



Free speed	200 rpm
Max. torque	27 Nm
Bolt capacity	Cl 8.8 M7 ● 11 mm
Bolt capacity	Cl 12.9 M6 ● 10 mm
Air inlet	1/4" GAS
Working pressure	6,2 bar
Internal hose size (Ø)	8 mm
Mean air consumption	96 l/min
Weight	0,6 kg

3/8	kg	0,6	1	019210015
-----	----	-----	---	-----------

1922P2

reversible air impact ratchet

3/8"

CE



Free speed	700 rpm
Maximum torque	68 Nm
Bolt capacity	Cl 8.8 M10 ● 16 mm
Bolt capacity	Cl 12.9 M8 ● 13 mm
Air inlet	1/4" GAS
Working pressure	6,2 bar
Internal hose size (Ø)	10 mm
Mean air consumption	88 l/min
Weight	0,6 kg

3/8	kg	0,6	1	019220010
-----	----	-----	---	-----------

Beta

1924B

compact reversible impact wrench

- "Pin Clutch" impulse device



Free speed	10,000 rpm
Max. torque	353 Nm
Bolt capacity	CI 8.8 M16 ● 24 mm
Bolt capacity	CI 12.9 M14 ● 21 mm
Air inlet	1/4" GAS
Working pressure	6,2 bar
Internal hose size (Ø)	8 mm
Mean air consumption	80 l/min
Weight	1,5 kg

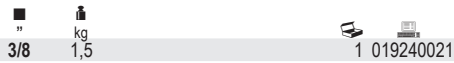

1927CD

reversible impact wrench, made from composite material

- Double hammer impulse device



Free speed	7,000 rpm
Max. torque	1.020 Nm
Bolt capacity	CI 8.8 M22 ● 34 mm
Bolt capacity	CI 12.9 M18 ● 27 mm
Air inlet	1/4" GAS
Working pressure	6,2 bar
Internal hose size (Ø)	10 mm
Mean air consumption	130 l/min
Weight	1,9 kg

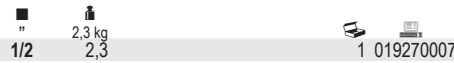

1927XM

compact reversible impact wrench

- Single hammer impulse device



Free speed	10,000 rpm
Max. torque	770 Nm
Bolt capacity	CI 8.8 M22 ● 34 mm
Bolt capacity	CI 12.9 M18 ● 27 mm
Air inlet	1/4" GAS
Operating pressure	6,2 bar
Internal hose size (Ø)	10 mm
Mean air consumption	122 l/min
Weight	1.3 kg

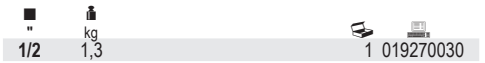

1924CD

reversible impact wrench, made from composite material

- Double hammer impulse device



Free speed	10,000 rpm
Max. torque	410 Nm
Bolt capacity	CI 8.8 M16 ● 24 mm
Bolt capacity	CI 12.9 M14 ● 21 mm
Air inlet	1/4" GAS
Working pressure	6,2 bar
Internal hose size (Ø)	8 mm
Mean air consumption	79 l/min
Weight	1,3 kg

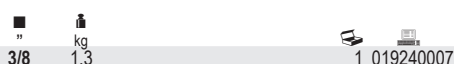

1927P

reversible impact wrench, made from composite material

- Double hammer impulse device



Free speed	7,500 rpm
Max. torque	1.750 Nm
Bolt capacity	CI 8.8 M24 ● 36 mm
Bolt capacity	CI 12.9 M20 ● 30 mm
Air inlet	1/4" GAS
Operating pressure	6,2 bar
Internal hose size (Ø)	10 mm
Mean air consumption	290 l/min
Weight	2 kg

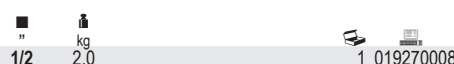

1927B

reversible impact wrench

- "Pin Clutch" impulse device



Free speed	7.000 rpm
Max. torque	705 Nm
Bolt capacity	CI 8.8 M22 ● 34 mm
Bolt capacity	CI 12.9 M18 ● 27 mm
Air inlet	1/4" GAS
Operating pressure	6,2 bar
Internal hose size (Ø)	10 mm
Mean air consumption	133 l/min
Weight	2,1 kg



1927AN

Angle reversible impact wrench

- Single hammer impulse device

12"

CE



Max. torque	244 Nm
Bolt capacity	244 Nm
Bolt capacity	CI 8.8 M14 ● 21 mm
Air inlet	CI 12.9 M12 ● 19 mm
Operating pressure	1/4" GAS
Internal hose size (Ø)	6,2 bar
Mean air consumption	10 mm
Weight	2.1 kg

1/2"	kg	1	019270012
	2,1		

1927G

compact reversible impact wrench

- Single hammer impulse device

12"

CE



Max. torque	8500 rpm
Bolt capacity	325 Nm
Bolt capacity	CI 8.8 M16 ● 24 mm
Air inlet	CI 12.9 M14 ● 21 mm
Operating pressure	1/4" GAS
Internal hose size (Ø)	6,2 bar
Mean air consumption	10 mm
Weight	113 l/min
Peso	1,2 kg

1/2"	kg	1	019270050
	1,2		

1927SP-AM

magnetic support for pneumatic impact wrench

- Fitted with two high-powered magnets with protective rubber tops
- Can accommodate 1 1/2" impact wrench, 4 sockets and 1 torque wrench
- Capacity: 10 kg



g	1	019270000
400		

1928XM

compact reversible impact wrench

- Double hammer impulse device

3/4"

CE



Free speed	4,800 rpm
Max. torque	1,600 Nm
Bolt capacity	CI 8.8 M22 ● 34 mm
Bolt capacity	CI 12.9 M18 ● 27 mm
Air inlet	3/8" GAS
Operating pressure	6,2 bar
Internal hose size (Ø)	10 mm
Mean air consumption	175 l/min
Weight	2.9 kg

3/4"	kg	1	019280030
	2,9		

1928CD

reversible impact wrench, made from composite material

- Double hammer impulse device

3/4"

CE



Free speed	4,500 rpm
Max. torque	1,800 Nm
Bolt capacity	CI 8.8 M27 ● 41 mm
Bolt capacity	CI 12.9 M24 ● 36 mm
Air inlet	3/8" GAS
Working pressure	6,2 bar
Internal hose size (Ø)	10 mm
Mean air consumption	215 l/min
Weight	3,5 kg

3/4"	kg	1	019280007
	3,5		

1928DA

reversible impact wrench

- Double hammer impulse device

3/4"

CE



Free speed	5,000 rpm
Max. torque	1,695 Nm
Bolt capacity	CI 8.8 M30 ● 46 mm
Bolt capacity	CI 12.9 M27 ● 41 mm
Air inlet	3/8" GAS
Working pressure	6,2 bar
Internal hose size (Ø)	10 mm
Mean air consumption	240 l/min
Weight	4,3 kg

3/4"	kg	1	019280022
	4,3		

1928DAL

reversible impact wrench

- Double hammer impulse device

3/4"

CE

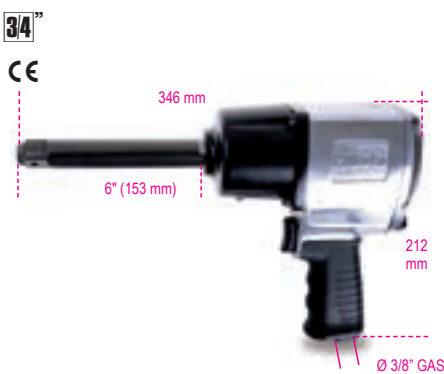

Free speed	5,000 rpm
Max. torque	1,695 Nm
Bolt capacity	CI 8.8 M27 ● 41 mm
Bolt capacity	CI 12.9 M24 ● 36 mm
Air inlet	3/8" GAS
Working pressure	6,2 bar
Internal hose size (Ø)	10 mm
Mean air consumption	240 l/min
Weight	4,8 kg

3/4"	kg	1	019280023
	4,8		

1928K4

assortment of one reversible impact wrench and four impact sockets, long series

• "Pin Clutch" impulse device

3/4"
CE



728L 27-30-32-36 mm

Free speed	4,000 rpm
Max. torque	1.493 Nm
Bolt capacity	CI 8.8 M27 ● 41 mm
Bolt capacity	CI 12.9 M24 ● 36 mm
Air inlet	3/8" GAS
Working pressure	6,2 bar
Internal hose size (Ø)	10 mm
Mean air consumption	260 l/min
Impact wrench weight	5,2 kg

3/4"	kg	1	019280104
410x330x106 mm			

1930LH

reversible impact wrench

• Double hammer impulse device

1"
CE



Free speed	6,000 rpm
Max. torque	2.441 Nm
Bolt capacity	CI 8.8 M36 ● 55 mm
Bolt capacity	CI 12.9 M30 ● 46 mm
Air inlet	1/2" GAS
Working pressure	6,2 bar
Internal hose size (Ø)	13 mm
Mean air consumption	280 l/min
Weight	7,1 kg

1"	kg	1	019300030
7,1			

1930LA

reversible impact wrench

• Double hammer impulse device

1"
CE



Free speed	4,000 rpm
Max. torque	2.445 Nm
Bolt capacity	CI 8.8 M36 ● 55 mm
Bolt capacity	CI 12.9 M30 ● 46 mm
Air inlet	1/2" GAS
Working pressure	6,2 bar
Internal hose size (Ø)	13 mm
Mean air consumption	460 l/min
Weight	10,6 kg

1"	kg	1	019300037
10,6			

1930CD

reversible impact wrench, made from composite material

• Double hammer impulse device

1"
CE



Free speed	4,000 rpm
Max. torque	2.445 Nm
Bolt capacity	CI 8.8 M36 ● 55 mm
Bolt capacity	CI 12.9 M30 ● 46 mm
Air inlet	1/2" GAS
Working pressure	6,2 bar
Internal hose size (Ø)	13 mm
Mean air consumption	320 l/min
Weight	7,1 kg

1"	kg	1	019300022
7,1			

1930PA

reversible impact wrench

• Double hammer impulse device

1"
CE



Free speed	3,500 rpm
Max. torque	2.445 Nm
Bolt capacity	CI 8.8 M36 ● 55 mm
Bolt capacity	CI 12.9 M30 ● 46 mm
Air inlet	1/2" GAS
Operating pressure	6,2 bar
Internal hose size (Ø)	13 mm
Mean air consumption	350 l/min
Weight	9,6 kg

1"	kg	1	019300032
9,6			

1930A

reversible impact wrench

• Double hammer impulse device

1"
CE



Free speed	4,000 rpm
Max. torque	2.445 Nm
Bolt capacity	CI 8.8 M36 ● 55 mm
Bolt capacity	CI 12.9 M30 ● 46 mm
Air inlet	1/2" GAS
Working pressure	6,2 bar
Internal hose size (Ø)	13 mm
Mean air consumption	460 l/min
Weight	9,5 kg

1"	kg	1	019300036
9,5			

1930HLA

reversible impact wrench

• Double hammer impulse device



Free speed	3,000 rpm
Max. torque	3.661 Nm
Bolt capacity	CI 8.8 M42●65 mm
Bolt capacity	CI 12.9 M33●50 mm
Air inlet	1/2" GAS
Working pressure	6,2 bar
Internal hose size (Ø)	13 mm
Mean air consumption	460 l/min
Weight	16,4 kg

1	kg	16,4	1	019300040
---	----	------	---	-----------

1931CD6

reversible drill,
made from composite material



Free speed	2,600 rpm
Chuck capacity	1÷6 mm
Power	0,23 kW
Spindle thread	3/8" - 24UNF
Air inlet	1/4" GAS
Working pressure	6,2 bar
Internal hose size (Ø)	8 mm
Mean air consumption	130 l/min
Weight	0,6 kg

0,6	kg	1	019310006
-----	----	---	-----------

1931CD13

reversible drill,
made from composite material



Free speed	800 rpm
Chuck capacity	1,0÷13 mm
Power	0,38 kW
Spindle thread	1/2" - 20UNC
Air inlet	1/4" GAS
Working pressure	6,2 bar
Internal hose size (Ø)	10 mm
Mean air consumption	170 l/min
Weight	1,3 kg

1,3	kg	1	019310013
-----	----	---	-----------

1930ZL

reversible impact wrench

• Double hammer impulse device



Free speed	3,000 rpm
Max. torque	4.068 Nm
Bolt capacity	CI 8.8 M42●65 mm
Bolt capacity	CI 12.9 M36●55 mm
Air inlet	1/2" GAS
Working pressure	6,2 bar
Internal hose size (Ø)	13 mm
Mean air consumption	480 l/min
Weight	15 kg

1 1/2	kg	15	1	019300070
-------	----	----	---	-----------

1931CD10

reversible drill,
made from composite material



Free speed	1,800 rpm
Chuck capacity	1÷10 mm
Power	0,38 kW
Spindle thread	3/8" - 24UNF
Air inlet	1/4" GAS
Working pressure	6,2 bar
Internal hose size (Ø)	10 mm
Mean air consumption	170 l/min
Weight	1 kg

1,0	kg	1	019310010
-----	----	---	-----------

1931AN10

reversible angle drill



Free speed	1,400 rpm
Chuck capacity	1÷10 mm
Power	0,38 kW
Spindle thread	3/8" - 24UNF
Air inlet	1/4" GAS
Working pressure	6,2 bar
Internal hose size (Ø)	10 mm
Mean air consumption	150 l/min
Weight	1,1 kg

1,1	kg	1	019310030
-----	----	---	-----------

1932B10

reversible drill



CE



Free speed	1,800 rpm
Chuck capacity	1÷10 mm
Power	0,44 kW
Spindle thread	3/8" - 24UNF
Air inlet	1/4" GAS
Working pressure	6,2 bar
Internal hose size (Ø)	10 mm
Mean air consumption	160 l/min
Weight	1,2 kg

kg
1,2



1 019320040

1932RS13

reversible drill



CE



Free speed	750 rpm
Chuck capacity	1,5÷13 mm
Power	0,55 kW
Spindle thread	3/8" - 24UNF
Air inlet	1/4" GAS
Working pressure	6,2 bar
Internal hose size (Ø)	10 mm
Mean air consumption	160 l/min
Weight	1,4 kg

kg
1,4



1 019320043

1932B13

reversible drill



CE



Free speed	400 rpm
Chuck capacity	1,5÷13 mm
Power	0,34 kW
Spindle thread	1/2" - 20UNC
Air inlet	1/4" GAS
Operating pressure	6,2 bar
Internal hose size (Ø)	10 mm
Mean air consumption	180 l/min
Peso	1,6 kg

kg
1,6



1 019320004

1933IH

high-power die grinder

• Collect chuck, Ø 3 mm and 6 mm



Free speed	20,000 rpm
Chuck capacity	3 - 6 mm
Power	0,75 kW
Air inlet	1/4" GAS
Working pressure	6,2 bar
Internal hose size (Ø)	10 mm
Mean air consumption	370 l/min
Weight	800 g

g
800



1 019330006

1933ILH

high-power long spindle die grinder

• Collect chuck, Ø 3 mm and 6 mm



Free speed	20,000 rpm
Chuck capacity	3 - 6 mm
Power	0,75 kW
Air inlet	1/4" GAS
Working pressure	6,2 bar
Internal hose size (Ø)	10 mm
Mean air consumption	370 l/min
Weight	1,2 kg

kg
1,2



1 019330011

1933AN90-H

high-power angle grinder

• Collect chuck, Ø 3 mm and 6 mm



Free speed	15,000 rpm
Chuck capacity	3 - 6 mm
Power	0,75 kW
Air inlet	1/4" GAS
Working pressure	6,2 bar
Internal hose size (Ø)	10 mm
Mean air consumption	370 l/min
Weight	1,1 kg

kg
1,1



1 019330021

1933

die grinder

• Collect chuck, Ø 3 mm and 6 mm



Free speed	25,000 rpm
Chuck capacity	3 - 6 mm
Power	0,20 kW
Air inlet	1/4" GAS
Working pressure	6,2 bar
Internal hose size (Ø)	10 mm
Mean air consumption	230 l/min
Weight	380 g

g
380



1 019330001

1933I

die grinder

- Collect chuck, Ø 3 mm and 6 mm

CE



Free speed	20,000 rpm
Chuck capacity	3 - 6 mm
Power	0,38 kW
Air inlet	1/4" GAS
Working pressure	6,2 bar
Internal hose size (Ø)	10 mm
Mean air consumption	260 l/min
Weight	670 g

g
670

1 019330005

1933L

long spindle die grinder

- Collect chuck, Ø 3 mm and 6 mm

CE



Free speed	25,000 rpm
Chuck capacity	3 - 6 mm
Power	0,20 kW
Air inlet	1/4" GAS
Working pressure	6,2 bar
Internal hose size (Ø)	10 mm
Mean air consumption	270 l/min
Weight	670 g

g
670

1 019330015

1933IL

long spindle die grinder

- Collect chuck, Ø 3 mm and 6 mm

CE



Free speed	20,000 rpm
Chuck capacity	3 - 6 mm
Power	0,38 kW
Air inlet	1/4" GAS
Working pressure	6,2 bar
Internal hose size (Ø)	10 mm
Mean air consumption	113 l/min
Weight	1,4 kg

kg
1,4

1 019330010

1933AN90

angle grinder

- Collect chuck, Ø 3 mm and 6 mm

CE



Free speed	20,000 rpm
Chuck capacity	3 - 6 mm
Power	0,20 kW
Air inlet	1/4" GAS
Working pressure	6,2 bar
Internal hose size (Ø)	10 mm
Mean air consumption	230 l/min
Weight	510 g

g
510

1 019330020

1934BV

low-speed tyre buffer

- Collect chuck, Ø 3 mm and 6 mm

CE



Free speed	3,700 rpm
Chuck capacity	3 - 6 mm
Power	0,37 kW
Air inlet	1/4" GAS
Operating pressure	6,2 bar
Internal hose size (Ø)	10 mm
Mean air consumption	113 l/min
Weight	0.84 kg

g
840

1 019340000

1934MAV

micro die grinder

CE



Free speed	56,000 rpm
Chuck capacity	3 mm
Power	0,04 kW
Air inlet	1/4" GAS
Operating pressure	6,2 bar
Internal hose size (Ø)	4,5 mm
Mean air consumption	115 l/min
Weight	0.2 kg

g
205

1 019340010

1934MAV70

high-speed micro die grinder

CE



Free speed	70,000 rpm
Chuck capacity	3 mm
Power	0,08 kW
Air inlet	1/4" GAS
Operating pressure	6,2 bar
Internal hose size (Ø)	4,5 mm
Mean air consumption	115 l/min
Weight	0.21 kg

g
210

1 019340030

Beta

1935F

reversible air screwdriver



4-16 Nm

Free speed	800 rpm
Torque range	4-16 Nm
Screw capacity	6-9 M
Bit holder	● 1/4"
Air inlet	1/4" GAS
Working pressure	6,2 bar
Internal hose size (Ø)	10 mm
Mean air consumption	150 l/min
Weight	1,3 kg

kg
1,3

1 019350045

1936/4A

angle grinder



Free speed	11,000 rpm
Grinding disc size	115 mm
Power	0,66 kW
Spindle thread	M14
Air inlet	1/4" GAS
Operating pressure	6,2 bar
Internal hose size (Ø)	10 mm
Mean air consumption	390 l/min
Weight	1,77 kg

kg
1,8

1 019360024

1936/5A

angle grinder



Free speed	10,000 rpm
Grinding disc size	125 mm
Power	0,66 kW
Spindle thread	M14
Air inlet	1/4" GAS
Working pressure	6,2 bar
Ø internal hose size	10 mm
Mean air consumption	390 l/min
Weight	1,9 kg

kg
1,9

1 019360025

1936/7A

angle grinder



Free speed	7600 giri/min
Grinding disc size	180 mm
Power	1,3 kW
Spindle thread	M14
Air inlet	3/8" GAS
Working pressure	6,2 bar
Ø internal hose size	13 mm
Mean air consumption	906 l/min
Weight	2,7 kg

kg
2,7

1 019360027

1937 2,5

roto-orbital palm sander, lubrication free, made from composite material

• Orbit diameter: 2.5 mm



Free speed	12.000 rpm
Power	0,18 kW
Pad size	150 mm
Orbit diameter	2,5 mm
Spindle thread	5/16"-24
Air inlet	1/4" GAS
Operating pressure	6,2 bar
Internal hose size (Ø)	10 mm
Mean air consumption	170 l/min
Weight	0,86 kg

kg
0,86

1 019370000

1937

Roto-orbital palm sander, lubrication free, made from composite material

• Orbit diameter: 5 mm



Free speed	12,000 rpm
Power	0,18 kW
Pad size	150 mm
Orbit diameter	5 mm
Spindle thread	5/16"-24
Air inlet	1/4" GAS
Operating pressure	6,2 bar
Internal hose size (Ø)	10 mm
Mean air consumption	170 l/min
Weight	0,86 kg

kg
0,86

1 019370001

1937R/P

6-hole pad, Ø 150 mm, for item 1937



1937R/P

1 019370002

1937KC

mini orbital sander

- Orbit diameter 4 mm
- 2 sanding pads (Ø 50 mm and Ø 75 mm)
- 10 abrasive paper discs (Ø 50 mm), grain 400, 600, 800
- 10 abrasive paper discs (Ø 75 mm), grain 400, 600, 800

CE



Free speed	15000
Power	0.25
Pad size	50 - 75
Spindle thread	M6 x 1.0
Air inlet	1/4"
Operating pressure	6.2 bar
Internal hose size (Ø)	10
Mean air consumption	79
Polisher weight	0.64
Kit weight	1.4

kg	1,4	1 019370171
----	-----	-------------

1937C...

Abrasive paper discs for item 1937KC

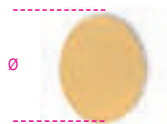

Ø mm	P	1	1
50	400	1	019370175
50	600	1	019370176
50	800	1	019370177
75	400	1	019370178
75	600	1	019370179
75	800	1	019370180

Beta

1937KL

mini polisher

- Sanding pad (Ø 75 mm)
- 2 polishing sponges (Ø 90 mm) - 1937/KL-DSB, 1937/KL-DSG
- Lambswool pad (Ø 90 mm) - 1937/KL-DLA

CE



Free speed	3,200 rpm
Power	0.25 kW
Pad size	75 mm
Spindle thread	M6
Air inlet	1/4" GAS
Operating pressure	6.2 bar
Internal hose size (Ø)	10 mm
Mean air consumption	91 l/min
Polisher weight	0.75 kg
Kit weight	1.8 kg

kg	1,8	1 019370161
----	-----	-------------

1937KL-D

accessories for item 1937KL



	Ø mm	1	1
1937KL-DLA	90	1	019370164
1937KL-DSB	90	1	019370165
1937KL-DSG	90	1	019370166

1937K...

Pads for items 1937KC and 1937KL



	Ø mm	1937KC	1937KL	1	1
1937KC-RP	50	•		1	019370173
1937KL-RP	75	•	•	1	019370163

1937RT

orbital palm sander, made from composite material, with suction system

- Orbit diameter 5 mm • Rectangular pad (100x110 mm)
- Delta pad (125x95 mm)

CE



Free speed	10,000 rpm
Orbit diameter	5 mm
Air inlet	1/4" GAS
Operating pressure	6.2 bar
Internal hose size (Ø)	10 mm
Mean air consumption	180 l/min
Weight	0.9 kg
Peso	0,9 kg

kg	0,9	1 019370021
----	-----	-------------

1937RT/R

rectangular pad for item 1937RT



	L mm	L1 mm	1	1
1937RT/R	110	100	1	019370022

1937RT/T

Delta pad for item 1937RT



	L mm	L1 mm	1	1
1937RT/T	125	95	1	019370023

Beta

Beta

1937M

multi-use sander
with 16 accessories

CE



Ø 1/4 GAS

Free speed	3,500 rpm
Power	0,34 kW
Air inlet	1/4" GAS
Working pressure	6,2 bar
Internal hose size (Ø)	10 mm
Mean air consumption	113 l/min
Sander weight	1,5 kg
Kit weight	4,5 kg

kg	4,5	1	019370011
mm	458x495x116		

1937M-01÷11

accessories for item 1937M



L mm	1937M-		
30		1	019370101
30		1	019370102
11		1	019370103
23		1	019370104
11		1	019370105
23		1	019370106
16		1	019370107
13	07	1	019370108
26	07	1	019370109
11	03, 05	1	019370110
23	01, 02, 04, 06	1	019370111

1937N10

pneumatic belt sander

CE



Free speed	20,000 rpm
Power	0,37 kW
Belt size	10x330 mm
Air inlet	1/4" GAS
Working pressure	6,2 bar
Internal hose size (Ø)	10 mm
Mean air consumption	374 l/min
Weight	0,9 kg

kg	0,9	1	019370041
----	-----	---	-----------

1937N10-GR

sand belts for item 1937N10



	P		
1937N10-GR60	60	1	019370146
1937N10-GR80	80	1	019370148
1937N10-GR100	100	1	019370150
1937N10-GR120	120	1	019370152

The prices shown are for 10 pieces

1937N20

pneumatic belt sander

CE



Free speed	16,000 rpm
Power	0,45 kW
Belt size	20x520 mm
Air inlet	1/4" GAS
Working pressure	6,2 bar
Internal hose size (Ø)	10 mm
Mean air consumption	400 l/min
Weight	1,6 kg

kg	1,6	1	019370051
----	-----	---	-----------

1937N20-GR

sand belts for item 1937N20



	P		
1937N20-GR60	60	1	019370156
1937N20-GR80	80	1	019370158
1937N20-GR100	100	1	019370160
1937N20-GR120	120	1	019370162

The prices shown are for 10 pieces

1938

Windscreen remover

• Supplied with 1 57 mm straight blade

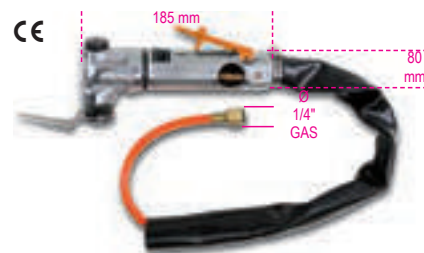

Oscillations/minute	20,000
Air inlet	1/4" GAS
Operating pressure	6,2 bar
Internal hose size (Ø)	6,5 mm
Mean air consumption	200 l/min
Weight	1,0 kg

kg	1,0	1	019380021
----	-----	---	-----------

1938R/L

blades for windscreen removers

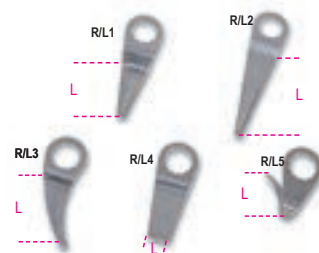

	L mm		
1938R/L1	57	1	019380041
1938R/L2	90	1	019380042
1938R/L3	50	1	019380043
1938R/L4	16	1	019380044
1938R/L5	36	1	019380045

1938R/S5

set of 5 blades for item 1938

1938R/S5	1	019380055
----------	---	-----------

1940

air hammer



Strokes per minute	3,500
Chisel inlet	○ 11 mm
Piston size	19 mm
Piston stroke	67 mm
Air inlet	1/4" GAS
Working pressure	6,2 bar
Ø internal hose size	8 mm
Mean air consumption	240 l/min
Weight	1,9 kg

kg 1,9 1 019400001

1940MT

spare retainer spring for item 1940



1940MT 5 019400110

1940S...

chisels for air hammers
item 1940



1940SN	5 019400020
1940ST	5 019400021
1940SD	5 019400022
1940SPS	5 019400023
1940SDT	5 019400024

1940/S5

set of 5 chisels for air hammers
item 1940



1940/S5 1 019400030

1940E10

air hammer



Strokes per minute	2,900
Chisel inlet	○ 10 mm
Piston size	19 mm
Piston stroke	67 mm
Air inlet	1/4" GAS
Operating pressure	6,2 bar
Internal hose size (Ø)	10 mm
Mean air consumption	76 l/min
Weight	1,7 kg

kg 1,7 1 019400010

1940E10/MT

spare retainer spring for item 1940E10



1940E10/MT 5 019400112

1940E10/S...

chisels for air hammers 1940E10

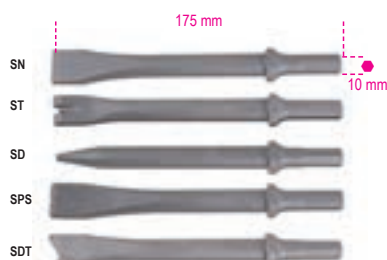

1940E10/SN	5 019400040
1940E10/ST	5 019400041
1940E10/SD	5 019400042
1940E10/SPS	5 019400043
1940E10/SDT	5 019400044

1940E10/S5

set of 5 chisels
for air hammers 1940E10



1940E10/S5 1 019400050

1942A

air saw

CE

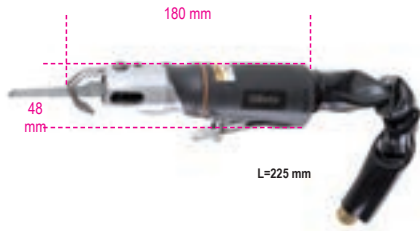

Strokes per minute	10.000
Stroke length	10 mm
Air inlet	1/4" GAS
Operating pressure	6,2 bar
Internal hose size (Ø)	8 mm
Mean air consumption	75 l/min
Weight	550 g

g	1	019420000
550		

1942LR

Bimetal blades
for air saw 1942A



1942LR	5	019420032
--------	---	-----------

1944A

axial needle scaler

CE



Strokes per minute	3.800
Stroke length	33 mm
N°. of needles	19
Needle size (Ø)	3 mm
Air inlet	1/4" GAS
Working pressure	6.2 bar
Internal hose size (Ø)	10 mm
Mean air consumption	85 l/min
Weight	2.8 kg

kg	1	019440011
2,8		

1944N

needle scaler

CE



Strokes per minute	3800
Stroke length	33 mm
N°. of needles	19
Needle size (Ø)	3 mm
Air inlet	1/4" GAS
Working pressure	6.2 bar
Internal hose size (Ø)	8 mm
Mean air consumption	85 l/min
Weight	2.7 kg

kg	1	019440002
2,7		

1944AR

set of needles
for needle scalars 1944N and 1944A



	Ø mm	n.	
1944AR 2	2	29	1 019440015
1944AR 3	3	19	1 019440005

1944PA

needle plates for items 1944N and 1944A



	Ø mm	N.	
1944PA 2	2	29	1 019440016
1944PA 3	3	19	1 019440006

Beta

1945S

stapler

• Uses staples type 80, section 0.95 x 0.65 mm (21-Gauge), length: 4 - 16 mm; width: 12.8 mm

CE



Magazine capacity	157 pcs
Air inlet	1/4" GAS
Working pressure	4,2 - 7 bar
Internal hose size (Ø)	8 mm
Air consumption (7 bar)	0.34 l/cycle
Weight	0.87 kg

kg	1	019450000
0,9		

1945S/G...

staples type 80, section 0.95x0.65 mm
(21-Gauge), width 12.8 mm, for item 1945S



	L mm	
• 1945S/G4	4	1 019450004
1945S/G6	6	1 019450006
1945S/G8	8	1 019450008
1945S/G10	10	1 019450010
1945S/G12	12	1 019450012
1945S/G14	14	1 019450014
1945S/G16	16	1 019450016

1945C

stapler, nailer, combo tool

• Uses staples type 90, section 1.25 x 1.0 mm (18-Gauge), length: 16 - 40 mm; width: 5.8 mm
• Uses round-headed nails type B12, section 1.25 x 1.0 mm (18-Gauge), 1.9-mm head

CE



Magazine capacity	100 pcs
Air inlet	1/4" GAS
Working pressure	5 - 8 bar
Internal hose size (Ø)	8 mm
Air consumption (7 bar)	1.12 l/cycle
Weight	1.16 kg

kg	1	019450200
1,16		

1945C/G...

staples type 90, section 1.25x1.0 mm (18-Gauge), width 5.8 mm, for item 1945C

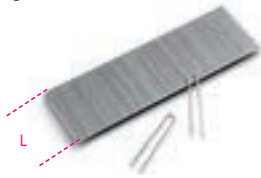

	L mm		
1945C/G16	16	1	019450216
1945C/G19	19	1	019450219
1945C/G22	22	1	019450222
1945C/G25	25	1	019450225
1945C/G28	28	1	019450228
1945C/G32	32	1	019450232
1945C/G35	35	1	019450235
1945C/G38	38	1	019450238
1945C/G40	40	1	019450240

1945C/GP...

nails type B12, section 1.25x1.0 mm (18-Gauge), 1.9 mm-head, for item 1945C

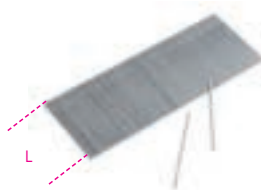

	L mm		
1945C/GP15	15	1	019450255
1945C/GP16	16	1	019450256
1945C/GP20	20	1	019450260
1945C/GP25	25	1	019450265
1945C/GP30	30	1	019450270
1945C/GP32	32	1	019450272
1945C/GP35	35	1	019450275
1945C/GP38	38	1	019450278
1945C/GP40	40	1	019450280
1945C/GP45	45	1	019450285
1945C/GP50	50	1	019450290

1945P

headless pinner

• Uses pins type B6, Ø 0.64 mm (23-Gauge), length: 12 - 35 mm



Magazine capacity	145 pcs
Air inlet	1/4" GAS
Working pressure	4 - 7 bar
Internal hose size (Ø)	8 mm
Air consumption (7 bar)	0.27 l/cycle
Weight	0.87 kg

kg	0,87	1	019450100
----	------	---	-----------

1945P/S...

pins type B6, Ø 0.64 mm (23-Gauge), for item 1945P

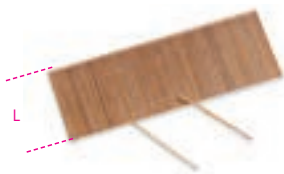

	L mm		
1945P/S12	12	1	019450112
1945P/S15	15	1	019450115
1945P/S18	18	1	019450118
1945P/S20	20	1	019450120
1945P/S21	21	1	019450121
1945P/S22	22	1	019450122
1945P/S25	25	1	019450125
1945P/S30	30	1	019450130
1945P/S35	35	1	019450135

1946T

air riveter

• supplied with interchangeable nozzles for steel, stainless steel, aluminium and copper rivets, 2.4 - 3.2 - 4.0 - 4.8 mm long



Traction power	9,000 N
Stroke length	16 mm
Maximum rivet capacity	Stainless steel Ø 4.8 mm
Air inlet	1/4" GAS
Working pressure	6,2 bar
Internal hose size (Ø)	8 mm
Air consumption	2.0 l/cycle
Weight	1.7 kg

kg	1,7	1	019460021
----	-----	---	-----------

1946C4,8

riveter

• Automatic suction
• Supplied assembled for use with 2.4 - 3.2 - 4.0 - 4.8 mm long steel, stainless steel, aluminium and copper rivets



Traction power	8,900 N
Stroke length	15 mm
Maximum rivet capacity	Stainless steel Ø 4.8 mm
Air inlet	1/4" GAS
Operating pressure	6,2 bar
Internal hose size (Ø)	10 mm
Air consumption	2.6 l/cycle
Weight	1.5 kg

kg	1,5	1	019460006
----	-----	---	-----------

1946C7,8

riveter

• Automatic suction
• Supplied assembled for use with 4.8 - 5.6 - 6.4 - 7.8 mm long steel, stainless steel, aluminium and copper rivets



Traction power	16,900 N
Stroke length	22.5 mm
Maximum rivet capacity	Stainless steel Ø 7.8 mm
Air inlet	1/4" GAS
Operating pressure	6,2 bar
Internal hose size (Ø)	10 mm
Air consumption	4.9 l/cycle
Weight	1.8 kg

kg	1,8	1	019460008
----	-----	---	-----------

1946C/T...

heads for structural rivets



	Ø mm		
1946C/T4,8	4,8	1	019460016
1946C/T6,4	6,4	1	019460018

Beta

1946KF

air riveter for threaded inserts

• Supplied assembled for threaded rivets made of steel, stainless steel, aluminium and copper, M4, M5, M6, M8



Traction power	14,235 N
Stroke length	7 mm
Maximum rivet capacity	Stainless steel Ø, M8
Air inlet	1/4" GAS
Operating pressure	6,2 bar
Internal hose size (Ø)	10 mm
Air consumption	2.1 l/cycle
Air riveter weight	2.1 kg
Kit weight	3.4 kg

kg	3,4
1	019460012

1946KF/M...

spare pins for item 1946KF



1946KF/M4	1	019460124
1946KF/M5	1	019460125
1946KF/M6	1	019460126
1946KF/M8	1	019460128

1947

bonding gun



Tube size	50x210 mm
Cartridge capacity	350 ml
Air inlet	1/4" GAS
Working pressure	4,8 bar
Internal hose size (Ø)	10 mm
Mean air consumption	120 l/min
Weight	1,1 kg

kg	1,1
1	019470001

1947H

bonding gun



Tube size	210x50 mm
Cartridge capacity	300/310 ml
Air inlet	1/4" GAS
Operating pressure	4 ÷ 8 bar
Internal hose size (Ø)	2,5 mm
Mean air consumption	120 l/min
Weight	750 g

g	750
1	019470011

1947G

grease gun

Die-cast aluminium head
Ergonomic grip for ease of access to tough greasing points
Corrosion-resistant brass valve
Takes 400 g cartridges or bulk grease up to 500 cc
Tube size: 54 (interior) x 260 mm
Air inlet: 1/4" GAS
Operating pressure: 4÷10 bar
Weight: 1.9 kg

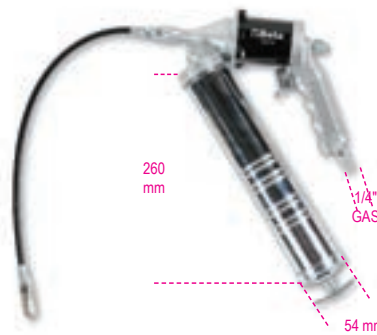

1947G	1	019470051
-------	---	-----------

1947M

gun for single-component sealants



Tube dimensions	210x50 mm
Cartridge capacity	310 ml
Air inlet	1/4" GAS
Working pressure	3 ÷ 5 bar
Nozzle Ø	1.6 - 2.5 mm
Mean air consumption	250 l/min
Weight	1.2 kg

kg	1,2
1	019470021

1947M -...

spare nozzles for item 1947M

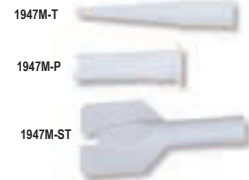

1947M-ST	10	019470025
1947M-T	10	019470026
1947M-P	10	019470027

1948

engraving pen



Strokes per minute	3500 ÷ 3800
Maximum hardness	60 HRC
Air inlet	1/4" GAS
Operating pressure	6,2 bar
Mean air consumption	50 l/min
Weight	150 g

g	150
1	019480001

1948PR

spare tungsten carbide bit
for item 1948

- Maximum hardness: 60 HRC



1948PR 1 019480005

1949U5

progressive blow gun with 5 nozzles

- Hard-wearing, shockproof composite material body
- 3 steel nozzles, 100/160/320 mm, scratchproof, protective rubber tips
- 1 "Turbo" nozzle made of fibreglass-reinforced nylon with safety tip
- 1 revolving nozzle, 100 mm, made of fibreglass-reinforced nylon
- With quick fixing system



Threaded brass insert	1/4" GAS
Working pressure	10 bar
Maximum working pressure	15 bar
Mean air consumption	280 l/min
Working temperature	-10°C ÷ 80°C
Weight	93 g

93 g 1 019490030

1949U5/A

steel nozzle, 100 mm, with scratchproof,
protective rubber tip, for item 1949U5



1949U5/A 1 019490131

1949U5/B

steel nozzle, 160 mm, with scratchproof,
protective rubber tip, for item 1949U5



1949U5/B 1 019490132

1949U5/C

steel nozzle, 320 mm, with scratchproof,
protective rubber tip, for item 1949U5



1949U5/C 1 019490133

1949U5/D

revolving nozzle, 100 mm, made of fibreglass
reinforced nylon, for item 1949U5



1949U5/D 1 019490134

1949U5/E

"Turbo" nozzle made of fibreglass-reinforced
nylon, with safety tip



1949U5/E 1 019490135

1949BC

progressive blow gun with rubber nozzle

- Hard-wearing, shockproof composite material body
- Replaceable scratchproof rubber nozzle



Aluminium threaded insert	1/4" GAS
Operating pressure	6-8 bar
Maximum operating pressure	15 bar
Mean air consumption	87 l/min
Operating temperature	-20°C ÷ 70°C
Weight	120 g

120 g 1 019490022

1949BC/RU

5 rubber nozzles for item 1949BC



1949BC/RU 1 019490122

1949T

telescopic progressive blow gun

- Hard-wearing, shockproof composite material body
- Telescopic steel swivel tube: 165 mm ÷ 300 mm

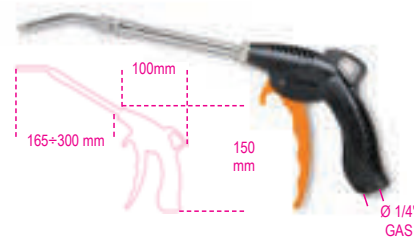

Aluminium threaded insert	1/4" GAS
Operating pressure	6-8 bar
Maximum operating pressure	15 bar
Mean air consumption	144 l/min
Operating temperature	-20°C ÷ 70°C
Weight	190 g

190 g 1 019490040

1949F

progressive blow gun

- Made from hard-wearing, shockproof, scratchproof, thermally insulated composite plastic material
- The special valve and the lever allow the circuit to be progressively opened, thus optimizing air flow



Brass threaded insert	1/4" GAS
Operating pressure	6-8 bar
Maximum operating pressure	10 bar
Operating temperature	-15°C ÷ 70°C
Weight	130 g

130 g 5 019490027



1949G

progressive blow gun
with air regulator

- Made from hard-wearing, shockproof, scratchproof, thermally insulated composite plastic material
- The special valve and the lever allow the circuit to be progressively opened, thus optimizing air flow



Brass threaded insert 1/4" GAS
Operating pressure 6-8 bar
Maximum operating pressure 10 bar
Operating temperature - 15 °C ÷ 70 °C
Weight 140 g

140 **5 019490035**

1949DGT

digital tyre inflator

- Operating pressure: 0÷11 bar (2.0÷160 psi)
- 4 units of measurement: psi/bar/kgcm²/kpa
- Backlit LCD display
- Reset feature
- Self-power off after 3 min.
- Pressure release button
- Resolution: 0.05 bar
- ABS housing, protective rubber shell on gauge, shockproof, nonslip handle grip
- Power supply: 2 AAA size 1.5V batteries
- Compatible with coupling 1916G 1/4"



1949DGT **0-11 500** **1 019490020**

1949GPE

tyre inflator

- Operating pressure: 0÷11 bars (10÷160 psi)
- Pressure release feature
- Pressure measurement feature
- Gauge coated with shockproof rubber
- 360 degree hose rotation



1949GPE **0÷11 640** **1 019490008**

1949GPN

tyre inflator,
ABS housing

- CE certified pressure gauge with scale 0.7÷12 bars (graduation: 1/10 bars)
- Two servo-controlled buttons allow accurate, quick tyre inflating (+) and deflating (-)
- Supplied with a calibration certificate
- Fitted with a shockproof, protective shell and an eyelet
- Fitted with a 1/4" GAS threaded coupler
- Swivel air inlet for rubber hose, Ø 7 mm



1949GPN **0,7÷12 810** **1 019490011**

1949M

tyre pressure tester



1949M **0÷4 5÷60 280** **1 019490400**

1951

cleaning gun

- For cleaning car upholstery, carpeting, seats and boots



Free speed
Tank capacity 1 L
Air inlet 1/4" GAS
Working pressure 6,2 bar
Internal hose size (Ø) 8 mm
Mean air consumption 110 l/min
Weight 650 g

650 **1 019510051**

1901BM/8

automatic hose reel
shock-proof plastic body
for compressed air or cold water

- Max. operating pressure: 12 bar

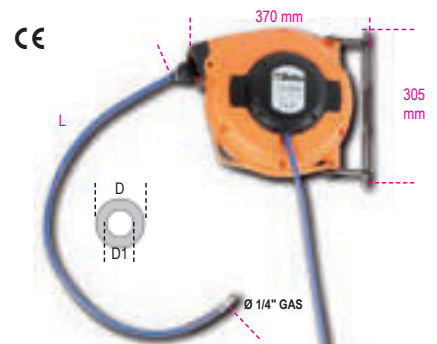

1901BM/8 **8x12 9÷1 1/4"** **1 019010111**

1901T/10

automatic hose reel,
shock-proof plastic body,
for compressed air or cold water

- Max. operating pressure: 15 bar



1901T/10 **10x14 15÷1 3/8"** **1 019010210**

Beta

1910/8 - 1910/10

automatic hose reel,
aluminium body,
for compressed air or cold water

• Max. operating pressure: 15 bar

CE



D1xD	L	A	B	ØGAS
mm	m	mm	mm	mm
8x12	9+1	375	130	1/4"

1910/8 1 019100008

D1xD	L	A	B	ØGAS
mm	m	mm	mm	mm
10x14	15+1	490	160	3/8"

1910/10 1 019100010

1914

polyurethane recoiled hoses, 98 Shore,
extendable

• Maximum operating pressure: 12 bar



L	D1xD	Ø GAS		
m	mm	BSP		
4	5x8	1/4"	1	019140054
6	5x8	1/4"	1	019140056
10	5x8	1/4"	1	019140060

1915B

polyurethane recoil hoses, 95 Shore,
extendable up to 9 m

• Maximum operating pressure: 10 bar

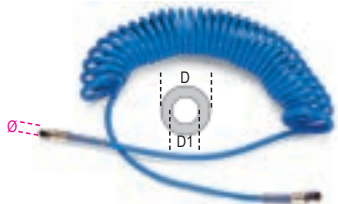

D1xD	Ø GAS		
mm	BSP		
6,5x10	1/4"	1	019150011
8x12	1/4"	1	019150012
11x16	3/8"	1	019150013

1915C

polyurethane recoil hoses, 95 Shore,
extendable up to 12 m

• Maximum operating pressure: 10 bar

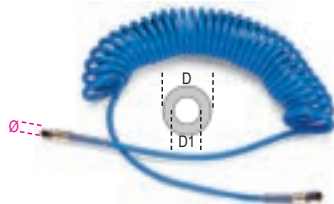

D1xD	Ø GAS		
mm	BSP		
6,5x10	1/4"	1	019150014
8x12	1/4"	1	019150015
11x16	3/8"	1	019150016

1915C/L

polyurethane recoil hoses, 95 Shore,
extendable up to 15 m

• Maximum operating pressure: 10 bar

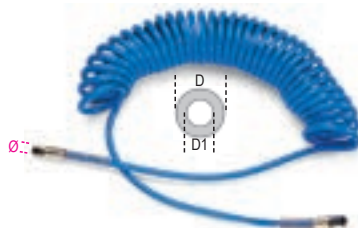

D1xD	Ø GAS		
mm	BSP		
8x12	1/4"	1	019150115
11x16	3/8"	1	019150116

1915D

braided polyurethane hose, 95 Shore, 9
metres long

• Maximum operating pressure: 15 bar



D1xD	Ø GAS		
mm	BSP		
8x12	1/4"	1	019150017
11x16	3/8"	1	019150018

1915E

braided polyurethane hose, 95 Shore,
12 metres long

• Maximum operating pressure: 15 bar



D1xD	Ø GAS		
mm	BSP		
8x12	1/4"	1	019150019
11x16	3/8"	1	019150020

1915E/XL

braided polyurethane coils, 95 Shore,
50 m long

• Maximum operating pressure: 15 bar



D1xD	Ø GAS		
mm	BSP		
8x12	1/4"	1	019150519
11x16	3/8"	1	019150520

1916I

quick couplings Italian profile
male threaded, cylindrical (BSP)



Ø GAS			
BSP			
1/4"	5	019160001	
3/8"	5	019160002	

1916G

quick couplings European profile
male threaded, tapered (BSPT)



Ø GAS			
BSPT			
1/4"	5	019160005	
3/8"	5	019160010	
1/2"	5	019160012	

1916GF

quick couplings, European profile,
female threaded, tapered (BSPT)



Ø GAS			
BSPT			
1/4"	5	019160055	
3/8"	5	019160060	

1916JM

quick couplings, Asian profile,
male threaded, tapered (BSPT)



Ø GAS			
BSPT			
1/4"	1	019160406	
3/8"	1	019160410	

1916JF

quick couplings, European profile, female threaded, cylindrical (BSP)

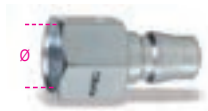

Ø GAS BSPT		
1/4"	1	019160456
3/8"	1	019160460

1916R

quick couplings, European profile, hose tail fitting, tapered (BSPT)



D1 mm		
6	5	019160106
8	5	019160108
11	5	019160111

1917M

universal ball quick couplers, shockproof rubber, male threaded, cylindrical (BSP)

- Designed for couplings 1916I and 1916G



Ø GAS BSP		
1/4"	5	019170001
3/8"	5	019170003
1/2"	5	019170004

1917F

universal ball quick couplers, shockproof rubber, female threaded, cylindrical (BSP)

- Matches couplings 1916I and 1916G



Ø GAS BSP		
1/4"	5	019170005
3/8"	5	019170010
1/2"	5	019170014

1917JM

ball quick couplers, Asian profile, male threaded, cylindrical (BSP)



Ø GAS BSP		
1/4"	1	019170406
3/8"	1	019170410
1/2"	1	019170412

1917JF

ball quick couplers, Asian profile, female threaded, cylindrical (BSP)



Ø GAS BSP		
1/4"	1	019170456
3/8"	1	019170460

1917RG

rotary universal coupler

- Made of aluminium, female threaded, cylindrical (BSP) male threaded, cylindrical (BSP)
- Matches all couplings with Italian and European profiles
- Rotates freely, even without connected area



Ø GAS BSP		
1/4"	1	019170252

1918

hose tail fitting, male threaded



D1 mm	Ø GAS BSPT		
8	1/4"	3	019180008
10	3/8"	3	019180010
12	1/2"	3	019180012

1919FE1/4

filter-regulator-lubricator



Air in/outlet	1/4" GAS BSPT
Pressure gauge inlet	1/8" GAS BSPT
Maximum air capacity	750 l/min
Maximum pressure	9,5 bar
Operating pressure	0,5 - 8,5 bar
Operating temperature	5 - 60 °C
Filter capacity	5 micron
Cup capacity	15 cc air / 25 cc oil
Weight	700 g

Weight	700 g
	1 019190200

1919RB-FE1/4

set of spare cups for item 1919FE1/4



	1 019190210
--	-------------

1919RF-FE1/4

spare filter for item 1919FE1/4



	1 019190230
--	-------------

1919RM-FE1/4

spare pressure gauge for item 1919FE1/4



	1 019190220
--	-------------

Beta

1919F1/4

filter-regulator-lubricator



Air in/outlet 1/4" GAS BSPT
Maximum air capacity 1000 l/min
Maximum pressure 9,5 bar
Operating pressure 0,5 - 8,5 bar
Operating temperature 5 - 60 °C
Filter capacity 5 microns
Cup capacity 60 cc air / 90 cc oil
Weight 1.3 kg

kg 1,3 1 019190250

1919F3/8

filter-regulator-lubricator



Air in/outlet 3/8" GAS BSPT
Maximum air capacity 1350 l/min
Maximum pressure 9,5 bar
Operating pressure 0,5 - 8,5 bar
Operating temperature 5 - 60 °C
Filter capacity 5 microns
Cup capacity 60 cc air / 90 cc oil
Weight 1.3 kg

kg 1,3 1 019190350

1919F1/2

filter-regulator-lubricator

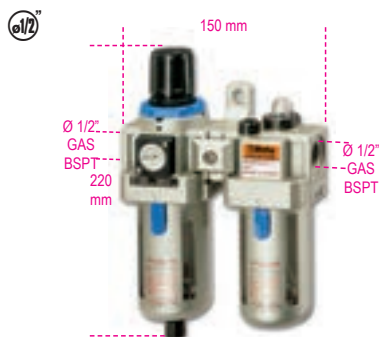

Air in/outlet 1/2" GAS BSPT
Maximum air capacity 2500 l/min
Maximum pressure 9,5 bar
Operating pressure 0,5 - 8,5 bar
Operating temperature 5 - 60 °C
Filter capacity 5 microns
Cup capacity 60 cc air / 90 cc oil
Weight 1.3 kg

kg 1,3 1 019190450

1919RB-F

set of spare cups for filters
 item 1919F - 1/4", 3/8" and 1/2"



1919RB-F 1 019190510

1919RF-F

spare filter for filters
 item 1919F - 1/4", 3/8" and 1/2"



1919RF-F 1 019190530

1919RM-F

spare pressure gauge for filters
 item 1919F - 1/4", 3/8" and 1/2"



1919RM-F 1 019190520

1919ML

mini lubricators



Ø	L	Ø			
1/4"	mm	mm			
63	36	1		019190030	
3/8"	63	36	1		019190032

1919SC

mini water separator

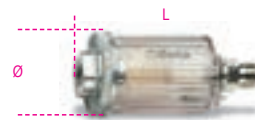

Ø	L	Ø		
1/4"	mm	mm		
80	40	1		019190035

1919L

ISO 32 lubricating oil

Density 20°C
Viscosity 40°C
Flammability COC

875 Kg/m³
32 cSt
210°C



cc 500 5 019190050

CONTAINERS AND ASSORTMENTS

			TOOL CASES & TROLLEYS						TOOL BAGS & BOXES											TOOL TROLLEYS																
			2009N/BV	2028/VV	2029/VV	2032TV	2033P/VV	2036TV	C4	C5	C6T	C7	C8	C10	C9	C10S	C11	CP15L	CP17	CP17L	C12	C14	CP15	C18	C19	C19L	C20	C20L	C41H	C42H						
		N° of pieces																																		
5915VU/0	Universal maintenance	35																																		
5915VU/1	Universal maintenance	45																																		
5915VU/2	Universal maintenance	49																																		
5915VU/3	Universal maintenance	74																																		
5915VU/4	Universal maintenance	80																																		
5915VU/5	Universal maintenance	111																																		
5915VU/AS	Universal maintenance	68																																		
5980EL/A	Electronic	57	417		417	417																														
5980EL/B	Electronic	98		418		418	418																													
5980ET/A	Electrotechnical	70	414		414																414															
5980ET/B	Electrotechnical	64		415		415	415														415															
5980ID	Plumbing	35	419																																	
5980MQ	Electrotechnical	46		416																																
5980U/BIKE	Bicycle and motorcycle repairs	90														410												410								
5914VU/M	Universal maintenance	109																				397														
5940SBK	Bicycle and motorcycle repairs	125																											433	433						
5941KART	Car repair	41											436	436	436								436	436												
5941VU-M	Universal maintenance	64																											434							

2001/B26

fabric wallet with assortment of 26 tools



2001/B26

1 020010060

55 6x7 - 8x9 - 10x11 - 12x13 - 14x15 - 16x17 mm

96N/SC9 1,5 - 2 - 2,5 - 3 - 4 - 5 - 6 - 8 - 10 mm

1044F 250 mm

1128BMX 145 mm

1150 180 mm

1201 3x75 - 4x100 - 5,5x150 mm

1202 PH1x80 - PH2x100 mm

1370 300 g

1692 2 m

1770A 9 mm

2001/BV

1 020010051

2005PA/D

tool pouch,
empty, made from nylon, with belt



2005PA/D

1 020050000

2005PA/S

tool pouch,
empty, made from nylon, with belt



2005PA/S

1 020050020

2009N/BV

leather bag for maintenance



mm
530x190x210

1 020090200

2009ID

bag with assortment of tools
for plumbing maintenance



2009ID
(2009N/BV+5980ID)

1 020090013

2028/VV

tool case, made of polypropylene

2 tool panels
Interior bottom with removable partitions
Double combination lock



mm
470x410x185 mm

1 020280010

2028E

tool case with assortments of tools
for electronic and electrotechnical maintenance



2028EL/A
(2028/VV+5980EL/A)

1 020280014

2028ET/A
(2028/VV+5980ET/A)

1 020280018

2029/VV

tool case, made of thick polypropylene,
aluminium edged

2 interior tool panels



mm
490x380x230

1 020290000

2029E

tool cases with assortments of tools
for electronic and electrotechnical
maintenance



2029BG-MQ
(2029/VV+5980MQ)

1 020290257

2029 ET/B
(2029/VV+5980ET/B)

1 020290021

2029 EL/B
(2029/VV+5980EL/B)

1 020290017

2029/RT

universal shoulder strap for bags and cases



2029/RT

1 020290900

2032/TV

tool trolley, made from plastic

2 tool panels
Tool pocket
Interior bottom with removable partitions



mm
430x370x200 1 020320110

2032/TE

tool trolley with assortments of tools for electronic and electrotechnical maintenance



2032TET/A (2032/TV+5980ET/A) 1 020320328
2032TEL/A (2032/TV+5980EL/A) 1 020320314

2033 P/VV

wall tool case, made from aluminium, with ABS sides

2 tool panels
Interior bottom with removable partitions



mm
500x380x200 1 020330300

2033P

tool cases with assortments of tools for electronic and electrotechnical maintenance



2033PET/B (2033P/VV+5980ET/B) 1 020330227
2033PEL/A (2033P/VV+5980EL/A) 1 020330214
2033PEL/B (2033P/VV+5980EL/B) 1 020330215

2036/TV

tool trolley, made of thick polypropylene, aluminium edged

2 tool panels
Telescopic handle
Ball bearing castors



mm
490x380x260 1 020360000

2036E

trolley with assortments of tools for electronic and electrotechnical maintenance



2036TET/B (2036/TV+5980ET/B) 1 020360223
2036EL/B (2036/TV+5980EL/B) 1 020360218

2037/TV

tool trolley, made of thick polypropylene, with 4 pivoting castors

Highly shock resistant. Suitable for tool transportation in aircraft.

2 removable tool panels.
Built-in document pocket.
4 removable pivoting castors for horizontal trolley handling.
2 tote-trays included
2 TSA approved locks with keys
Rubber-coated handle



mm
420x325x275 mm 1 020370000

2038/TV

tool trolley, made of thick polypropylene

- Highly shock resistant
- Aluminium sealing profile
- 2 TSA approved locks with keys
- 2 removable tool panels.
- Telescopic handle and big ball bearing castors
- 2 ergonomic rubber-coated handles (including 1 side handle)
- Capacious bottom
- Document pocket
- 3 tote drawers



mm
430x500x340 1 020380000

2041UC

Utility Case with assortment of 33 tools



2041UC 1 020410210

- 55 6x7 - 8x9 - 10x11 - 12x13 - 14x15 - 16x17 mm
- 96/SC9 1,5 - 2 - 2,5 - 3 - 4 - 5 - 6 - 8 - 10 mm
- 111 200 mm
- 1048V 250 mm
- 1128BMX 145 mm
- 1150 180 mm
- 1201 2,5x50 - 3x75 - 4x100 - 5,5x100 - 6,5x150 mm
- 1202 PH0x60 - PH1x80 - PH2x100 mm
- 1370 300 g
- 1692 3m
- 1771 170 mm
- 1834/70 70 Lumen / 140 mm
- 1639NS-N 25m
- 1696 200 mm

535x282x87 mm - 4,5 Kg

2051N

assortment of 55 tools
for nautical maintenance
with shockproof polypropylene case



2051N 1 020510210

- 42 7 - 8 - 10 - 12 - 13 - 14 - 17 - 19 mm
- 55AS 3/8x7/16 - 1/2x9/16 - 5/8x11/16"
- 96/SC9 \varnothing 1,5+10 mm
- 111 200 mm
- 920A \varnothing 10 - 12 - 13 - 14 - 17 - 19 mm
- 920AS \varnothing 7/16 - 1/2 - 9/16 - 11/16 - 7/8"
- 920/22 255 mm - \square 1/2 - \blacksquare 1/2
- 920/25 \square 1/2 - \blacksquare 1/2
- 920/42 \blacksquare 1/2
- 920/55 \blacksquare 1/2
- 956C \square 1/2 - 16 - 20,8 mm
- 1048 250 mm
- 1084BM 160 mm
- 1128BMX 145 mm
- 1150BM 180 mm
- 1166BM 160 mm
- 1201 \bullet 3x75 - 4x100 - 5,5x150 - 6,5x150 mm
- 1202 \oplus PH1x80 - PH2x100 mm
- 1390 \varnothing 35 mm
- 1490/2 \varnothing max 240 mm
- 1737 145 mm
- 1778X
- BMN 3.6 x 140 mm
- BME-SB 19 mm x 25 mm

585x393x92 mm - 9 kg

2055HB

"Home Bag" case with assortment of 24 tools



2055HB 1 020550220

- 55 6x7 - 8x9 - 10x11 - 12x13 mm
- 96N/SC9 1,5 - 2 - 2,5 - 3 - 4 - 5 - 6 - 8 - 10 mm
- 1128BMX 145 mm
- 1150 180 mm
- 1048V 250 mm
- 1201 3x75 - 4x100 - 5,5x100 mm
- 1202 PH0x60 - PH1x80 - PH2x100 mm
- 1370 300 g
- 1692 3m

373x275x70 mm - 3 Kg

2060/VV

hard cavity wall tool case

Floating, waterproof/watertight
Made from thick resin
With manual pressure release valve



IP67

490x410x210 mm 1 020600101

2080/V6

organizer tool case with 6 removable tote-trays
and adjustable partitions



2080/V6 385x320x60 mm 1 020800060

2080/V6-U

removable tote-tray for organizer tool case
2080/V6



2080/V6-U 1 020800066

90x60x50 mm

2080/V12

organizer tool case with 12 removable tote-
trays



2080/V12 300x145x330 mm 1 020800000

2080/V12-...

removable tote-tray for organizer tool case
2080/V12



2080/V12-S 3 020800013

2080/V12-M 2 020800015

2080/V12-L 1 020800020

295x75x65 mm

C4 - 2104

tool basket made of technical fabric

Removable internal tool panel
Internal and external pockets and elastic tool holder
Sturdy waterproof base with rubber feet
Supplied with shoulder strap



C4	1 021040000
2104VU/0	1 021040122
(C4+5915VU/0)	

360x330x260x mm - 2,5 kg

C5 - 2105

tool rucksack, made of technical fabric



C5	1 021050000
2105VU0	1 021050122
(C5+5915VU/0)	

500x400x180 mm - 2,5 Kg

C6T - 2106

tool rucksack, made of technical fabric, with castors



C6T	1 021060010
2106T/VU0	1 021060123
(C6T+5915VU/0)	

480x370x220 mm - 4,5 kg

C7 - 2107

technical fabric tool bag

2 removable interior tool panels
Interior PC pocket
2 exterior front pockets
Interior bottom made of plastic, with removable partitions



C7	1 021070000
2107VU/2	1 021070112
(C7+5915VU/2)	
2107VU/3	1 021070114
(C7+5915VU/3)	

440x370x170 mm - 3,5 kg

C8 - 2108

technical fabric tool trolley



C8	1 021080000
2108 VU/1	1 021080022
(C8+5915VU/1)	

470x370x280 mm - 4 kg

C9 - 2109

technical fabric tool bag

- Hard base
- Interior and exterior tool pockets
- Exterior pocket with zip closure for enhanced safety
- Pocket with strap closure for personal belongings
- Double bottom
- Double string for levels
- Shoulder strap for easier transport



C9	1 021090000
2109 VU/1	1 021090022
(C9+5915VU/1)	
2109VU/3	1 021090024
(C9+5915VU/3)	

550x280x320 mm - 2,6 kg

C9/RT

shoulder strap for items C4,C7,C9,C10,C10S,C11 and C12



C9/RT	1 021090900
-------	-------------

Beta

C10 - 2110

technical fabric tool box

Hard frame
Double bottom. Bottom can be removed for increased bag capacity
Tilting handle for easier access to tools
Elastic tool bands and interior and exterior pockets
Cover
Tool tray included in double bottom



C10	1	021100000
2110 VU/1 (C10+5915VU/1)	1	021100031
2110VU/3 (C10+5915VU/3)	1	021100034
2110VU/AS (C10+5915VU/AS)	1	021100036

520x220x250 mm - 3,3 kg

C10S - 2110S

technical fabric tool box

Hard frame
Double bottom. Bottom can be removed for increased bag capacity
Tilting handle for easier access to tools
Elastic tool bands and interior and exterior pockets
Cover
Tool tray included in double bottom



C10S	1	021100001
2110S VU/1 (C10S+5915VU/1)	1	021100041
2110SVU/3 (C10S+5915VU/3)	1	021100044

420x220x250 mm - 2,3 kg

C11 - 2111

technical fabric tool box



C11	1	021110000
2111 VU/1 (C11+5915VU/1)	1	021110031
2111VU/3 (C11+5915VU/3)	1	021110034

400x240x220 mm - 2 kg

C12 - 2112

technical fabric tool bag

Removable interior tool panel
Elastic tool bands and capacious interior and exterior pockets
Bag opens at front for easier access to tools at workplace
Hard, waterproof base with rubber feet
Can be used with trolley C8



C12	1	021120000
2112ET/A (C12+5980ET/A)	1	021120028
2112ET/B (C12+5980ET/B)	1	021120029
2112VU/5 (C12+5915VU/5)	1	021120056

500x370x270 mm - 5 kg

C13

tool trunk with castors,
made of sturdy polypropylene



C13	1	021130000
-----	---	-----------

870x410x350 mm - 7,2 kg

C14

tool trolley, made of polypropylene, with 4 drawers

- Injection polypropylene frame for increased shock resistance.
- Lid-protected front accommodates 4 pull-out drawers (470x255):
1 drawer 30 mm high
2 drawers 60 mm high
1 drawer 90 mm high
- Front centralized lock allows top and front lids to be closed simultaneously.
- Two side handles
- 4 sturdy rear castors
- Removable top tray
- Tool panel built into lid
- 3 tote-trays included
- Nameplate
- Can be closed with TSA lock



C14	1	021140000
2114VU/M (C14+5914VU/M)	1	021140011

580x380x455 mm - 10 kg

CP15 - 2115

tool box, made from plastic, removable tote-tray and tool trays

- 1 tool tray built into cover
- 2 removable tool trays with adjustable partitions
- 1 interior tote-tray with adjustable partitions



CP15	1	021150201
2115PVU/1 (CP15+5915VU/1)	1	021150232
2115PVU/2 (CP15+5915VU/2)	1	021150234

445x240x250 mm - 2 kg

CP15L - 2115

tool box, long series, made from plastic, removable tote-tray and tool trays

- 3 tool trays built into cover with adjustable partitions
- 1 interior tote-tray with adjustable partitions



CP15L	1	021150202
2115PL-VU/1 (CP15L+5915VU/1)	1	021150242
2115PL-VU/3 (CP15L+5915VU/3)	1	021150245

558x277x270 mm - 2,5 kg



2115P L-MQ32

assortment of 32 insulated tools for hybrid cars, in plastic tool box with soft thermoformed tray



2115PL-MQ32	1	021150332
-------------	---	-----------

- 920MQ/55A
 - 89MQ 10-12 mm
 - 850MQ 1/4"
- 860TX/A10 T7-T8-T9-T10-T15-T20-T25-T27-T30-T40
- 920MQ/A 8-10-12-13-14-17-19 mm
- 920MQ/21 125mm
- 920MQ/22 250mm
- 1048MQ250 250mm
- 1150MQ 180mm
- 1164MQ160 160mm
- 1272MQ 4.5X80-6X100mm
- 1274MQ 3X100-4X100-5.5X125
- 1995MQ/G2 G2
- CP15L

C16 - 2116

tool box, made of plastic, with interior object compartment, empty



C16	1	021160000
2116 VU/1 (C16+5915VU/1)	1	021160102
2116VU/3 (C16+5915VU/3)	1	021160105

500x260x260 mm - 2,5 kg

CP17 - CP17L - 2117

tool box, made of stainless steel and plastic, removable tote-tray



CP17
500x200x220 mm



CP17L
575x245x265 mm

CP17	1	021170500
2117P-VU/1 (CP17+5915VU/1)	1	021170042
2117P-VU/3 (CP17+5915VU/3)	1	021170045
CP17L	1	021170502
2117L-VU/1 (CP17L+5915VU/1)	1	021170142
2117PL-VU/3 (CP17L+5915VU/3)	1	021170145

C18 - 2118

tool box made from sheet metal



C18	1	021180001
2118 VU/1 (C18+5915VU/1)	1	021180032

450x200x100 mm - 3 kg



C19 - 2119 - C19L - 2119L

three-section cantilever tool box,
made from sheet metal



C19

≡ 450x200x160 mm



C19L

≡ 550x200x160 mm

C19	1	021190001
2119VU/3 (C19+5915VU/3)	1	021190025
C19L	1	021190002
2119L-VU/3 (C19L+5915VU/3)	1	021190125

C20 - C20L - 2120

five-section cantilever tool box,
made from sheet metal



C20

≡ 450x200x210 mm



C20L

≡ 550x200x210 mm

C20	1	021200001
2120 VU/2 (C20+5915VU/2)	1	021200061
2120VU/3 (C20+5915VU/3)	1	021200063
2120 VU/4 (C20+5915VU/4)	1	021200064
2120VU/AS (C20+5915VU/AS)	1	021200068
C20L	1	021200002
2120L-VU/2 (C20L+5915VU/2)	1	021200161
2120L-VU/3 (C20L+5915VU/3)	1	021200163
2120L-VU/4 (C20L+5915VU/4)	1	021200164
2120L-VU/AS (C20L+5915VU/AS)	1	021200168

C20TSS

five-section cantilever tool box, made of AISI
304 stainless steel



C20TSS	1	021203001
--------	---	-----------

≡ 450x200x210 mm - 4kg

C22B

tool trunk,
made of sheet metal



C22B O

≡ 720x320x310 mm



C22BM O

≡ 850x360x350 mm



C22BL O

≡ 1010x410x400 mm

C22B-O	1	022000150
C22BM-O	1	022000160
C22BL-O	1	022000170

C22B O: 13 kg
C22BM O: 20 kg
C22BL O: 26 kg

C22W

tool trunk,
made from sheet metal,
lined for enhanced tool protection



C22W O

≡ 690x300x360 mm



C22WL O

≡ 990x300x360 mm

C22W-O	1	022000269
C22WL-O	1	022000299

C22W O: 15 kg
C22WL O: 28 kg

C22P

tool trunk for building yards, made of sheet
metal

built-in, retractable handles
raised shoes for forklift truck handling
double burglar-proof lock closure (not included)



C22PM O

≡ 915x540x430 mm



C22PL O

≡ 1220x720x615 mm

C22PM-O	1	022000240
C22PL-O	1	022000245

C22PM O: 39 kg
C22PL O: 67 kg

ROLLER CABS & CONTAINERS

					C22S	C23S	C23SC	C23ST	C24S/5	C24S/6	C37/6	C39/6	C24SA/6	C24SA/7	C24SA-XL/7	C24SL-CAB	C37/7	C39/7		
					N° of pieces															
LOOSE TOOLS	without supports	5902MT	Earth moving	106	420	420	420													
		5902MT/AS	Earth moving	99	421	421	421													
		5902VI	Industrial maintenance	107	382	382	382													
		5904VG/3	Car repair	132								425			425					
		5905VG/1	Car repair	94																
		5905VG/2	Car repair	118																
		5910VI/3	Industrial maintenance	297																
	with supports	5954VG	Car repair	128																
		5954VI	Industrial maintenance	133																
		5957U-P	Universal maintenance	133																
		5957VG	Car repair	174																
		5957VI	Industrial maintenance	162																
		5958U	Universal maintenance	85																
		TRAYS	soft modules	5904VG/1M	Car repair	76				422	422	422	422							
5904VG/2M	Car repair			170				423	423	423	423	423								
5904VU/1M	Universal maintenance			91				393	393	393	393	393								
5904VU/2M	Universal maintenance			151				394	394	394	394	394								
5927VU/M	Universal maintenance			108	405	405	405													
5935ET/1MB	Electrotechnical			95																
5935VG/1MB	Car repair			98																
5935VI/1MB	Industrial maintenance			94																
5935VI/2MB	Industrial maintenance			133																
5935VU/1MB	Universal maintenance			154																
5945VUM	Universal maintenance			231																
5988ROAD/7M	Bicycle and motorcycle repairs			333																
5988U6/M	Universal maintenance			214																412
foam trays	5904VI/1T			Industrial maintenance	98				383	383	383	383								
	5904VI/2T		Industrial maintenance	153				384												384
	5904VI/3T		Industrial maintenance	142																
	5904VG/2T		Car repair	99				424	424	424	424									
	5904VG/3T		Car repair	102				426	426	426	426									
	5904VG/5T		Car repair	153				427			427									
	5904VU/2T		Universal maintenance	104				395	395	395	395									
	5904VU/3T		Universal maintenance	146				396	396	396	396									
	5908VG/2T		Car repair	212																
	5908VI/2T		Industrial maintenance	232																
	5910VG/3T		Car repair	202																
	5910VI/3T		Industrial maintenance	261																
	5938U/2T		Universal maintenance	210																

C22S

portable tool chest
with three drawers

Main features:

- Three drawers (588x277 mm) with ball bearing slides:
- 1 drawer, 50 mm high
- 2 drawers, 70 mm high.
- Front centralized safety lock.
- Retractable side handles for ease of handling.

📦 19 kg



C22S-O



C22S-G



C22S-R



h	max
50 mm	25 kg
70 mm	25 kg

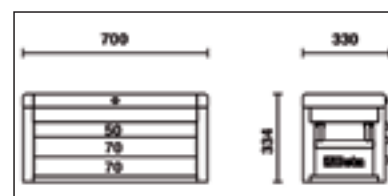
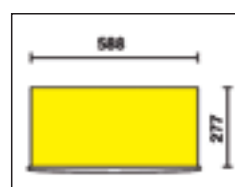

C22S-O	1	022000501
C22S-G	1	022000502
C22S-R	1	022000503

C23S

portable tool chest
with five drawers

Main features:

- Five drawers (588x277 mm) with ball bearing slides:
- 2 drawers, 50 mm high
- 3 drawers, 70 mm high.
- Front centralized safety lock.
- Retractable side handles for ease of handling.

📦 26 kg



C23S-G



C23S-R



C23S-O



h	max
50 mm	25 kg
70 mm	25 kg

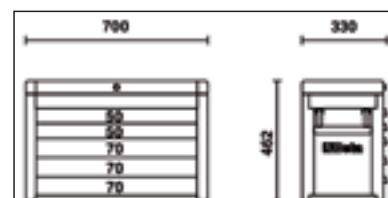
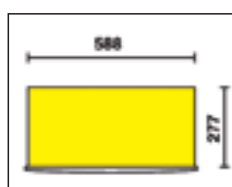

C23S-O	1	023000501
C23S-G	1	023000502
C23S-R	1	023000503

CD23S

Caddy trolley

Main features:

- ABS worktop designed to match tool chests C22S, C23S, C23SC.
- The removable handle can be stored underneath the chassis.
- Four castors 125 mm in Ø:
- 2 fixed and 2 steering (one with brake).
- Maximum load: 250 kg.

📦 14 kg

CD23S	1	023000610
-------	---	-----------



C23SC

portable tool chest
with eight drawers

Main features:

- Eight drawers with ball bearing slides:
4 drawers, 50 mm high
3 drawers, 70 mm high
1 drawer, 100 mm high.
- Front centralized safety lock.
- Retractable side handles for ease of transport.

📦 28 kg



C23SC-G



C23SC-R



C23SC-O



h	max
50 mm	25 kg
70 mm	25 kg

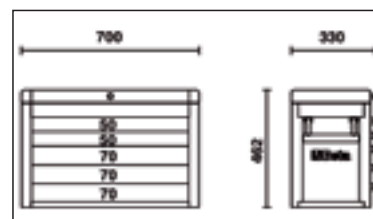
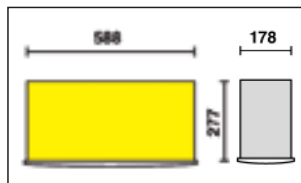

C23SC-O	1	023000511
C23SC-G	1	023000512
C23SC-R	1	023000513

C23ST

portable tool chest
with five drawers

Main features:

- Five drawers (588x367 mm) with ball bearing slides:
5 drawers, 70 mm high.
- Front centralized safety lock.
- Can be fitted with kit composed of 4 castors and 1 handle (2300ST/KIT)

📦 36 kg



C23ST-G



C23ST-R



C23ST-O



h	max
70 mm	25 kg

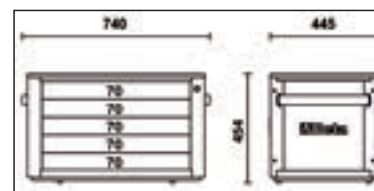
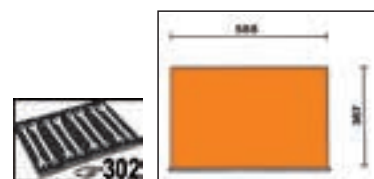

C23ST-O	1	023000521
C23ST-G	1	023000522
C23ST-R	1	023000523

2300ST/KIT

kit with 4 castors and 1 handle for item C23ST

- Four castors 125 mm in Ø:
2 fixed and 2 steering (two with brakes).
- Telescopic handle

📦 6,5 kg



2300ST/KIT	1	023000950
------------	---	-----------

C24S/5

mobile roller cab with five drawers

Main features:

- Five drawers (588x367 mm) with ball bearing slides:
 - 2 drawers, 70 mm high
 - 2 drawers, 140 mm high
 - 1 drawer, 280 mm high
- Drawer bases protected by foamed rubber mats.
- Four castors 125 mm in Ø:
 - 2 fixed and 2 steering (one with brake).
- Front centralized safety lock.
- Static load capacity: 800 kg.
- Thermoplastic worktop designed to match tool chests C22S, C23S, C23SC and C23ST
- Integrated side bottle holder.
- Paper roll holder item 2400S-R/PC can also be included.

800 kg



C24S/5-O

52 kg



C24S/5-G



C24S/5-R

h	max
70 mm	25 kg
140 mm	30 kg
280 mm	35 kg

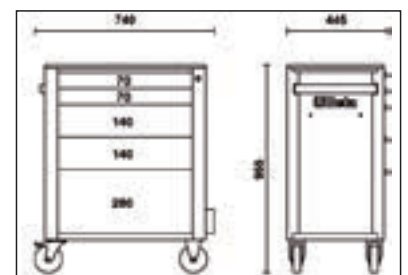
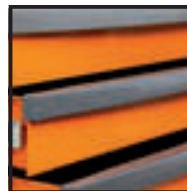

C24S/5-O	1	024002051
C24S/5-G	1	024002052
C24S/5-R	1	024002053

C24S/6

mobile roller cab with six drawers

Main features:

- Six drawers (588x367 mm) with ball bearing slides:
 - 4 drawers, 70 mm high
 - 1 drawer, 140 mm high
 - 1 drawer, 280 mm high
- Drawer bases protected by foamed rubber mats.
- Four castors 125 mm in Ø:
 - 2 fixed and 2 steering (one with brake).
- Front centralized safety lock.
- Static load capacity: 800 kg.
- Thermoplastic worktop designed to match tool chests C22S, C23S, C23SC and C23ST.
- Integrated side bottle holder.
- Paper roll holder item 2400S-R/PC can also be included.

800 kg



C24S/6-O

55 kg



C24S/6-G



C24S/6-R

h	max
70 mm	25 kg
140 mm	30 kg
280 mm	35 kg

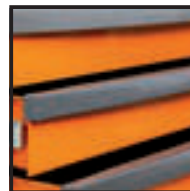

C24S/6-O	1	024002061
C24S/6-G	1	024002062
C24S/6-R	1	024002063

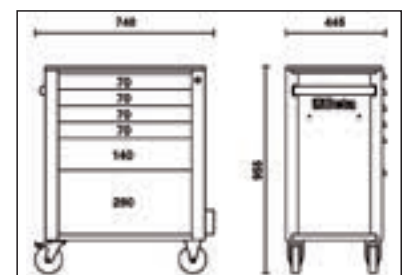

C24S/7

mobile roller cab with seven drawers

Main features:

- Seven drawers (588x367 mm) with ball bearing slides:
- 5 drawers, 70 mm high
- 1 drawer, 140 mm high
- 1 drawer, 210 mm high
- Drawer bases protected by foamed rubber mats.
- Four castors 125 mm in Ø:
- 2 fixed and 2 steering (one with brake).
- Front centralized safety lock.
- Static load capacity: 800 kg.
- Thermoplastic worktop designed to match tool chests C22S, C23S, C23SC and C23ST
- Integrated side bottle holder.
- Paper roll holder item 2400S-R/PC can also be included.

58 kg

800
kg



C24S/7-O



C24S/7-G



C24S/7-R

h	max
70 mm	25 kg
140 mm	30 kg
210 mm	30 kg

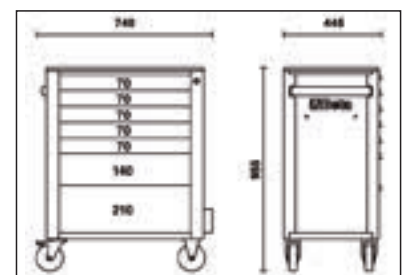
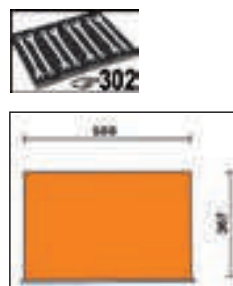
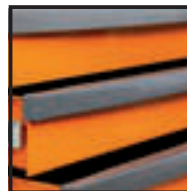

C24S/7-O	1	024002071
C24S/7-G	1	024002072
C24S/7-R	1	024002073

C24S/8

mobile roller cab with eight drawers

Main features:

- Eight drawers (588x367 mm) with ball bearing slides:
 - 6 drawers, 70 mm high
 - 2 drawers, 140 mm high
- Drawer bases protected by foamed rubber mats.
- Four castors 125 mm in Ø:
 - 2 fixed and 2 steering (one with brake).
- Front centralized safety lock.
- Static load capacity: 800 kg.
- Thermoplastic worktop designed to match tool chests C22S, C23S, C23SC and C23ST.
- Integrated side bottle holder.
- Paper roll holder item 2400S-R/PC can also be included.

61 kg

800 kg



C24S/8-O



C24S/8-G



C24S/8-R

h	max
70 mm	25 kg
140 mm	30 kg

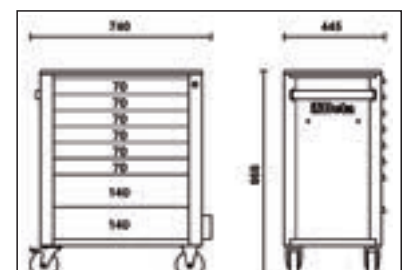
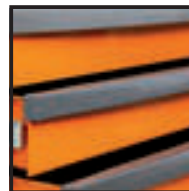

C24S/8-O	1	024002081
C24S/8-G	1	024002082
C24S/8-R	1	024002083

C24SA/6

mobile roller cab with six drawers,
with anti-tilt system

Main features:

- Six drawers (588x367 mm), with ball bearing slides:
 - 4 drawers, 70 mm high
 - 1 drawer, 140 mm high
 - 1 drawer, 280 mm high.
- Drawer bases protected by foamed rubber mats.
- Four castors Ø 125 mm:
 - 2 fixed and 2 steering (one with brake).
- Front centralized safety lock.
- Static load capacity: 800 kg.
- Thermoplastic worktop designed to match tool chests C22S, C23S, C23SC and C23ST
- Integrated side bottle holder.
- Paper roll holder item 2400S-R/PC can also be included.

55 kg

800
kg



C24SA/6-O



C24SA/6-G



C24SA/6-R

h	max
70 mm	25 kg
140 mm	30 kg
280 mm	35 kg

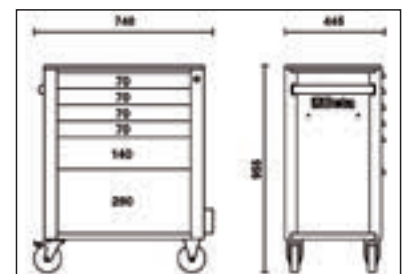
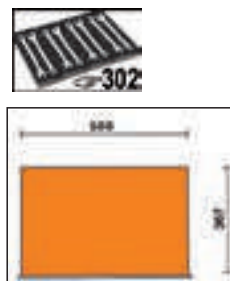

C24SA/6-O	1	024002161
C24SA/6-G	1	024002162
C24SA/6-R	1	024002163

C24SA/7

mobile roller cab with 7 drawers,
with anti-tilt system

Main features:

- Seven drawers (588x367 mm) with ball bearing slides:
- 5 drawers, 70 mm high
- 1 drawer, 140 mm high
- 1 drawer, 210 mm high
- Drawer bases protected by foamed rubber mats.
- Does not allow simultaneous opening of several drawers
- Four castors 125 mm in Ø:
- 2 fixed and 2 steering (one with brake)
- Front centralized safety lock
- Static load capacity: 800 kg
- Integrated side bottle holder

58 kg

800
kg



C24SA/7-O



C24SA/7-G



C24SA/7-R

h	↓ max
70 mm	25 kg
140 mm	30 kg
210 mm	30 kg

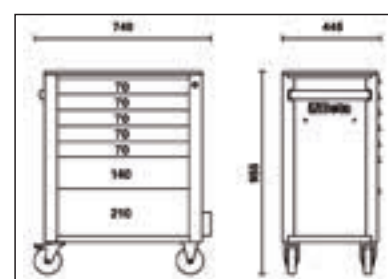

C24SA/7-O	1	024002171
C24SA/7-G	1	024002172
C24SA/7-R	1	024002173

C24SA/8

mobile roller cab with eight drawers,
with anti-tilt system

Main features:

- 8 drawers (588x367 mm), with ball bearing slides:
- 6 drawers, 70 mm high
- 2 drawers, 140 mm high.
- Drawer bases protected by foamed rubber mats.
- Four castors Ø 125 mm:
- 2 fixed and 2 steering (one with brake).
- Front centralized safety lock.
- Static load capacity: 800 kg.
- Thermoplastic worktop designed to match tool chests C22S, C23S, C23SC and C23ST.
- Integrated side bottle holder.
- Paper roll holder item 2400S-R/PC can also be included.

61 kg

800
kg



C24SA/8-O



C24SA/8-G



C24SA/8-R

h	max
70 mm	25 kg
140 mm	30 kg

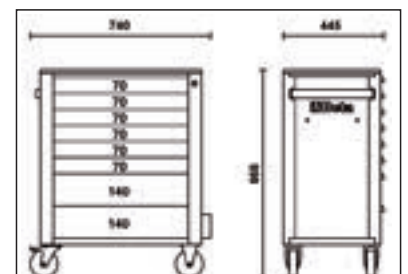
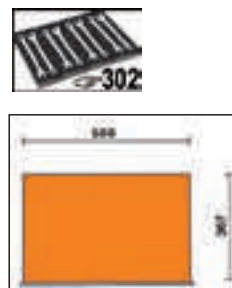

C24SA/8-O	1	024002181
C24SA/8-G	1	024002182
C24SA/8-R	1	024002183

C24SA-XL/7

mobile roller cab with 7 drawers,
with anti-tilt system,
long model

Main features:

- 7 drawers (882x367) mm, with ball bearing slides:
- 5 drawers, 70 mm high
- 1 drawer, 140 mm high
- 1 drawer, 210 mm high
- Sturdy ABS worktop, with 6 tool trays.
- Sturdy nylon front, with integrated label holder.
- Drawer bases protected by foamed rubber mats.
- Four castors 125 mm in Ø:
- 2 fixed and 2 steering (one with brake).
- Front centralized safety lock.
- Static load capacity: 1,000 kg.
- Integrated side bottle holder.

84 kg

1000
kg



C24SAXL7-O



C24SAXL7-G



C24SAXL7-R

h	max
70 mm	30 kg
140 mm	35 kg
210 mm	35 kg

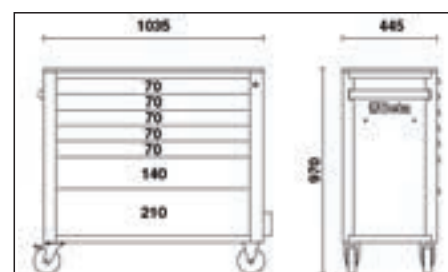
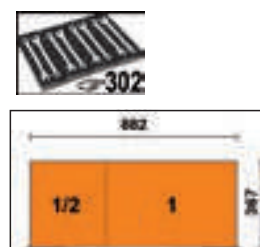

C24SAXL7-O	1	024002271
C24SAXL7-G	1	024002272
C24SAXL7-R	1	024002273

C24SA-XL/8

mobile roller cab with eight drawers,
with anti-tilt system,
long model

Main features:

- 8 drawers (882x367 mm), with ball bearing slides:
- 6 drawers, 70 mm high
- 2 drawers, 140 mm high.
- Sturdy ABS worktop, with 6 tool trays.
- Sturdy nylon front, with integrated label holder.
- Drawer bases protected by foamed rubber mats.
- Four castors Ø 125 mm:
- 2 fixed and 2 steering (one with brake).
- Front centralized safety lock.
- Static load capacity: 1,000 kg.
- Integrated side bottle holder.
- Paper roll holder item 2400S-R/PC can also be included.

88 kg

1000
kg



C24SAXL/8-O



C24SAXL/8-G



C24SAXL/8-R

h	max.
70 mm	30 kg
140 mm	35 kg



C24SAXL/8-O	1	024002281
C24SAXL/8-G	1	024002282
C24SAXL/8-R	1	024002283

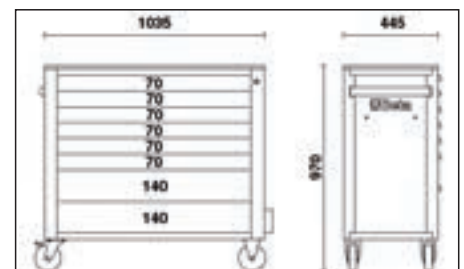

C24SA-XL/9

mobile roller cab with nine drawers,
with anti-tilt system,
long model

Main features:

- 9 drawers (882x367 mm), with ball bearing slides:
- 8 drawers, 70 mm high
- 1 drawer, 140 mm high
- Sturdy ABS worktop, with 6 tote-trays.
- Sturdy nylon front, with built-in label holder.
- Drawer bases protected by foamed rubber mats.
- Four castors Ø 125 mm:
- 2 fixed and 2 steering (one with brake).
- Front centralized safety lock.
- Static load capacity: 1,000 kg.
- Built-in side bottle holder.
- Paper roll holder item 2400S-R/PC can also be included.

90 kg

1000 kg



C24SAXL/9-O



C24SAXL/9-G



C24SAXL/9-R

h	max
70 mm	30 kg
140 mm	35 kg

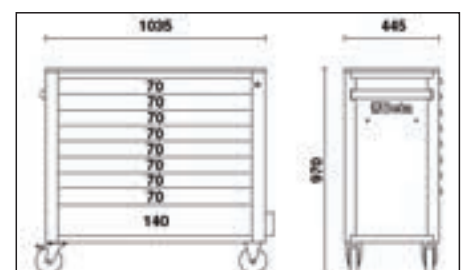
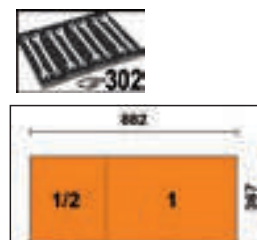

C24SAXL/9-O	1	024002331
C24SAXL/9-G	1	024002332
C24SAXL/9-R	1	024002333

2400S-R/PC

paper roll holder

- Matches roller cabs C24S

0,3 kg

2400SR/PC-O	1	024002951
2400SR/PC-G	1	024002952
2400SR/PC-R	1	024002953



2400S R/PC-O



2400S R/PC-G



2400S R/PC-R



2400S/PF

bottle holder

- Matches roller cabs C24S

0,5 kg

2400S/PF	1	024002906
----------	---	-----------



2499PF

bottle holder

- Can match roller cabs C38, C38A

2,5 kg

2499PF-O	1	024990210
2499PF-G	1	024990219
2499PF-R	1	024990230

2499PF O



2499PF G



2499PF R



2499PF/M

universal magnetic bottle holder

2,2 kg

2499PF/M	1	024990050
----------	---	-----------



2499PC

paper roll holder

- Matches all Tank and roller cabs and C38, C38A.

2,2 kg

2499PC	1	024990090
--------	---	-----------



C24SL

mobile roller cab
with seven drawers
and side tops

Main features:

- Seven drawers (588x367 mm) with ball bearing slides:
 - 5 drawers, 70 mm high
 - 1 drawer, 140 mm high
 - 1 drawer, 210 mm high.
- Drawer bases protected by foamed rubber mats.
- Four castors 125 mm in Ø:
 - 2 fixed and 2 steering (two with brakes).
- Front centralized safety lock.
- Static load capacity: 1.100 kg.
- Multi-ply wood worktop with holes for a vice (1599F/100, to be ordered separately).
- Side compartment with vertically adjustable top.
- Integrated paper roll holder.
- Double rear bottle holder.

80 kg

C24SL-O	1	024002101
C24SL-G	1	024002102
C24SL-R	1	024002103



h	max
70 mm	25 kg
140 mm	30 kg
210 mm	30 kg

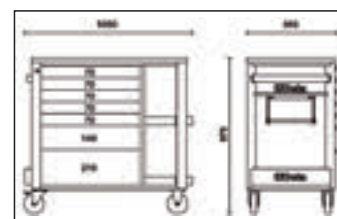

C24SL-CAB

mobile roller cab
with seven drawers
and tool cabinet

Main features:

- Seven drawers (588x367 mm) with ball bearing slides:
 - 5 drawers 70 mm high
 - 1 drawer 140 mm high
 - 1 drawer 210 mm high.
- Drawer bases protected by foamed rubber mats.
- Four castors, Ø 125 mm:
 - 2 fixed and 2 steering (two with brakes).
- Front centralized lock.
- Side tool cabinet with lockable door and vertically adjustable interior top.
- Static load capacity: 1,100 kg.
- Multi-ply wood worktop with holes for a vice (1599F/100, to be ordered separately).
- Built-in paper roll holder.
- Double rear bottle holder.

82 kg

C24SL-CAB/O	1	024002191
C24SL-CAB/G	1	024002192
C24SL-CAB/R	1	024002193



h	max
70 mm	25 kg
140 mm	30 kg
210 mm	30 kg

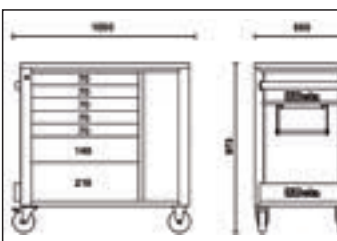

C04TSS-7

mobile roller cab with seven drawers, made entirely of stainless steel,
Non-marking wheels

Main features:

- Seven drawers (570 x 410 mm) with ball bearing slides;
- 6 drawers, 83 mm high;
- 1 drawer, 170 mm high;
- 4 castors Ø 125 mm
- 2 fixed and 2 steering (two with brakes);
- Front centralized lock;
- Frame made entirely of stainless steel AISI 304
- Castors, supports, ball bearings, drawer interiors and guides made of stainless steel
- Drawer handles made of aluminium

63 kg

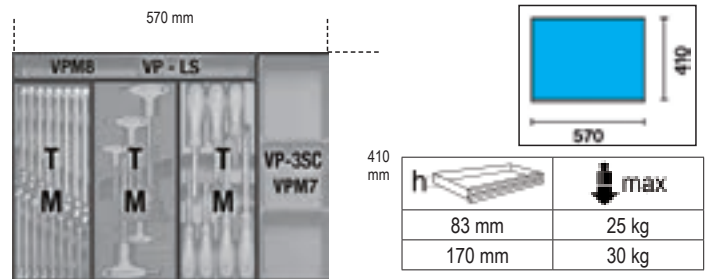

C04TSS/7

1 024003077 262

C25

Tank trolley with shelf

Main features:

- Foldaway lid.
- 1 sliding drawer.
- Tool tray protected by foamed rubber mats.
- Shelves protected by oil and fuel proof mats.
- Four castors 100 mm in ø:
 2 fixed and 2 swivelling (one with brake).
- Safety lock.
- One more shelf M4 can be added on the opposite side.
- Empty thermoformed tray for 1/2" sockets and accessories (024990104).
- Paper roll holder item 2499PC can also be included

31,5 kg

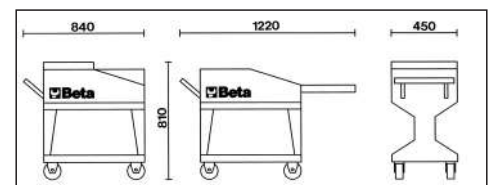

C25

1 025000001

C27S

folding tool trolley for outdoor jobs

Folding tool trolley. Its unique patented design guarantees an effortless transport.

2 drawers, 588x277 mm, with ball bearing slides for two-way opening.

Large lower object compartment, 588x277x220 mm.

Sheet metal frame.

2 fixed castors, Ø 160 mm, and 2 steering castors with brake, Ø 100 mm

Thermoplastic worktop with 6 built-in tool trays.

Centralized lock.

Can accommodate drawer partitions and MC foam tool trays

 20 kg



C27S-O



C27S-G



C27S-R



 h	 max
70 mm	20 kg

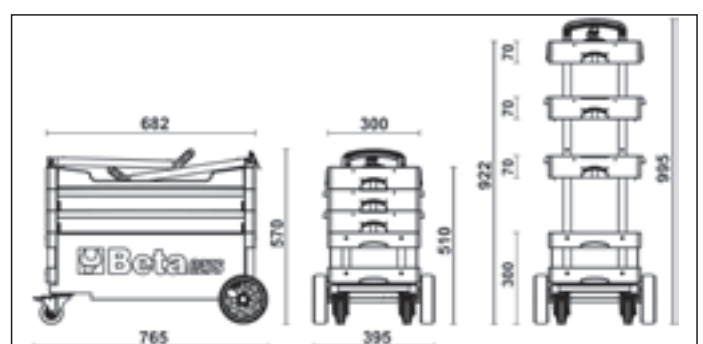
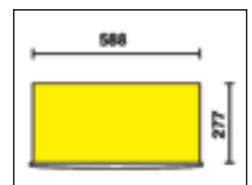

C27S-O	1		027000201
C27S-G	1		027000202
C27S-R	1		027000203

C28

SuperTank trolley with worktop and ten drawers

Main features:

- Ten drawers (588x367 mm) with ball bearing slides
- Quick, safe system for opening and closing drawers, with nylon and fibreglass front
- Five side drawers:
 - 4 drawers, 70 mm high
 - 1 drawer, 210 mm high
- Five front drawers:
 - 4 drawers, 70 mm high
 - 1 drawer, 210 mm high
- Drawer bases protected by foamed rubber mats
- Four high-capacity castors 150 mm in Ø:
 - 2 fixed and 2 steering (with brakes)
- 2 centralised safety locks
- Multiply wood worktop with holes for a vice (1599F/150, to be ordered separately)
- 4 bottle holders: 2 front and 2 rear
- 6 side tool trays
- Side compartment with foldaway door with lock
- 135-mm-high storage compartment with plastic-covered base
- Static load capacity: 1200 kg

1200
kg



C28-O

130 kg



C28-G



C28-R



h	max
70 mm	25 kg
210 mm	30 kg

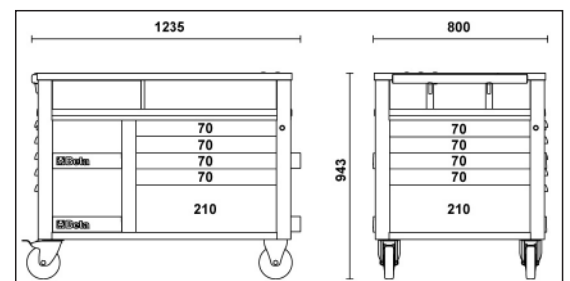

C28-O	1	028000301
C28-G	1	028000302
C28-R	1	028000303

C30S

MaxiTank mobile workbench

Main features:

- 5 front drawers with ball bearing slides:
 - 3 drawers (367x588 mm), 90 mm high
 - 1 drawer (610x588 mm), 90 mm high
 - 1 drawer (610x588 mm), 180 mm high.
- Quick opening system with aluminium front.
- Drawer bases protected by foamed rubber mats.
- Can accommodate thermoformed trays.
- One hydraulic jack, designed to lift front part easily.
- Four high-capacity castors:
 - 2 steering, front, Ø 150 mm
 - 2 fixed, rear, Ø 170 mm.
- Oil-proof, rubber-coated worktop, 1300x800 mm, with drain hole for fluid collection in a small tank.
- Can accommodate vice item 1599F/150 (to be ordered separately).
- Storage compartment, 720x250x1300 mm, with PVC-coated worktop, and front sliding panels.
- Centralized lock for drawers and panels.
- Integrated side bottle holders.
- Integrated paper roll holder.
- Static load capacity: 1,800 kg.
- Can accommodate a multi-ply wood worktop (3000 S/PLM), to be ordered separately.
- Can accommodate vice item 1599F/150 (to be ordered separately).



1800
kg

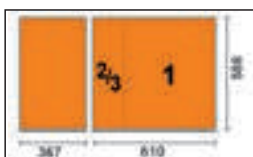

 200 kg

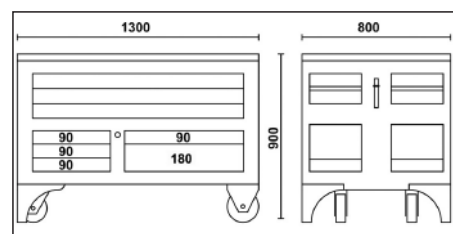

h	max
90 mm	30 kg
180 mm	35 kg



C30S

 1  030000100

3000S/PLM

wood worktop for item C30S

 10 kg



 1240x740x26 mm

3000S/PLM

 1  030000150

C35/6G

industrial tool chest with six drawers

Main features:

- Six pull-out drawers (600x447 mm):
 - 2 drawers, 75 mm high
 - 1 drawer, 100 mm high
 - 1 drawer, 150 mm high
 - 1 drawer, 200 mm high
 - 1 drawer, 300mm high
- Front centralized safety lock.
- Can accommodate an ABS worktop and drawer partitions, to be ordered separately.

73,5 kg

1200 kg



h	max
75 mm	70 kg
100 mm	70 kg
150 mm	70 kg
200 mm	70 kg
300 mm	70 kg

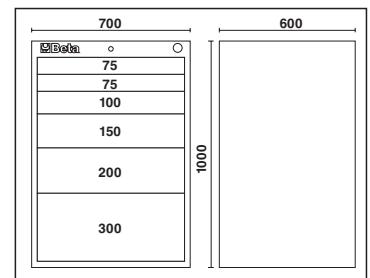
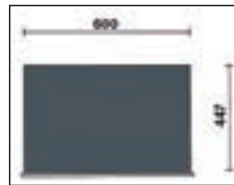

C35/6G



1 035000062

C35/7G

industrial tool chest with seven drawers

Main features:

- Seven pull-out drawers (600x447 mm):
 - 2 drawers, 75 mm high
 - 1 drawer, 100 mm high
 - 3 drawers, 150 mm high
 - 1 drawer, 200 mm high
- Front centralized safety lock.
- Can accommodate an ABS worktop and drawer partitions, to be ordered separately.

77 kg

1200 kg



h	max
75 mm	70 kg
100 mm	70 kg
150 mm	70 kg
200 mm	70 kg

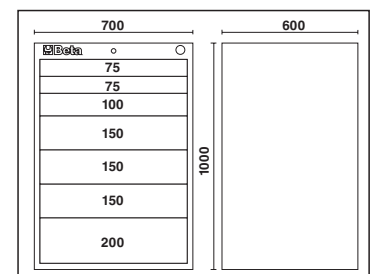
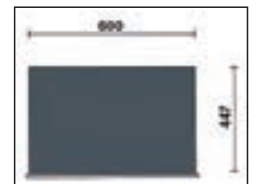

C35/7G



1 035000072

C35/8G

industrial tool chest with eight drawers

Main features:

- Eight pull-out drawers (600x447 mm):
 - 4 drawers, 75 mm high
 - 1 drawer, 100 mm high
 - 2 drawers, 150 mm high
 - 1 drawer, 200 mm high
- Front centralized safety lock.
- Can accommodate an ABS worktop and drawer partitions, to be ordered separately.

80,5 kg

035000082



1

035000082

1200 kg



h	max
75 mm	70 kg
100 mm	70 kg
150 mm	70 kg
200 mm	70 kg



700	600
75	1000
75	
75	
100	
150	
150	
200	

C35/9G

industrial tool chest with nine drawers

Main features:

- Nine pull-out drawers (600x447 mm):
 - 6 drawers, 75 mm high
 - 3 drawers, 150 mm high
- Front centralized safety lock.
- Can accommodate an ABS worktop and drawer partitions, to be ordered separately.

84 kg

C35/9G



1

035000092

1200 kg



h	max
75 mm	70 kg
150 mm	70 kg

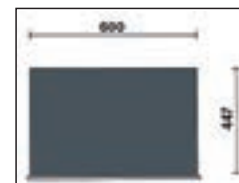

700	600
75	1000
75	
75	
75	
75	
75	
150	
150	
150	

3500/P

Worktop with edge for tool chest C35

3500/P

700x600 mm



1

035000502



3500/D

adapters for drawer C35

Allow dimensions of drawer of tool chest C35 to be adapted, so that all standard foam trays can be used

3500/D



1

035000503



C37/6

mobile roller cab
with 6 drawers

Main features:

- 6 drawers (588x367 mm) with ball bearing slides:
- 4 drawers 75 mm high
- 1 drawer 150 mm high
- 1 drawer 305 mm high
- Sturdy multi-purpose worktop.
- Tote-trays and holes for accommodating screwdrivers.
- Convenient "V"-shaped groove for working pipes and sections.
- Quick release system made of aluminium, opening throughout length of drawer.
- Corner bumpers throughout height of roller cab, to avoid damaging vehicles in garage.
- Drawer bases protected by foamed rubber mats.
- Four castors Ø 125 mm:
- 2 fixed and 2 steering (one with brake).
- Front centralized safety lock.
- Static load capacity: 1000 kg.
- Built-in side bottle and paper holders, adjustable in several positions.

1000
kg



C37/6-O

 69 kg



C37/6-G



C37/6-R

h	max
75 mm	30 kg
150 mm	35 kg
305 mm	40 kg

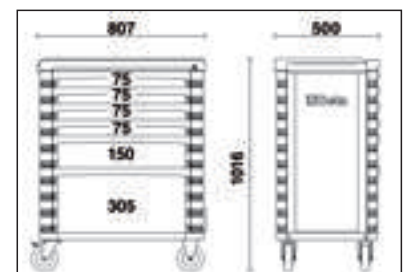
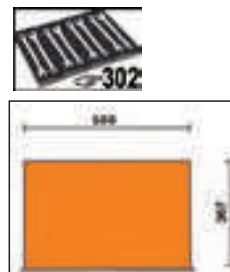

C37/6-O	1	037000061
C37/6-G	1	037000062
C37/6-R	1	037000063

C37/7

mobile roller cab
with 7 drawers

Main features:

- 7 drawers (588x367 mm) with ball bearing slides:
- 5 drawers 75 mm high
- 1 drawer 150 mm high
- 1 drawer 225 mm high
- Sturdy multi-purpose worktop.
- Tote-trays and holes for accommodating screwdrivers.
- Convenient "V"-shaped groove for working pipes and sections.
- Quick release system made of aluminium, opening throughout length of drawer.
- Corner bumpers throughout height of roller cab, to avoid damaging vehicles in garage.
- Drawer bases protected by foamed rubber mats.
- Four castors Ø 125 mm:
- 2 fixed and 2 steering (one with brake).
- Front centralized safety lock.
- Static load capacity: 1000 kg.
- Built-in side bottle and paper holders, adjustable in several positions.

1000
kg



C37/7-O

71 kg



C37/7-G



C37/7-R

h	max
75 mm	30 kg
150 mm	35 kg
225 mm	35 kg

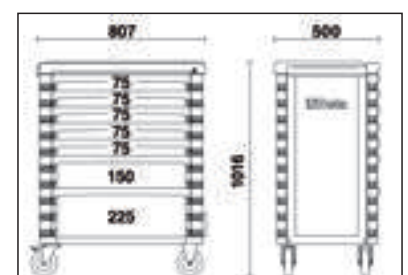

C37/7-O	1	037000071
C37/7-G	1	037000072
C37/7-R	1	037000073

C37/8

mobile roller cab
with 8 drawers

Main features:

- 8 drawers (588x367 mm) with ball bearing slides:
- 6 drawers 75 mm high
- 2 drawers 150 mm high
- Sturdy multi-purpose worktop.
- Tote-trays and holes for accommodating screwdrivers.
- Convenient "V"-shaped groove for working pipes and sections.
- Quick release system made of aluminium, opening throughout length of drawer.
- Corner bumpers throughout height of roller cab, to avoid damaging vehicles in garage.
- Drawer bases protected by foamed rubber mats.
- Four castors Ø 125 mm:
- 2 fixed and 2 steering (one with brake).
- Front centralized safety lock.
- Static load capacity: 1000 kg.
- Built-in side bottle and paper holders, adjustable in several positions.



C378-O

73 kg



C378-G



C378-R

h	max
75 mm	30 kg
150 mm	35 kg

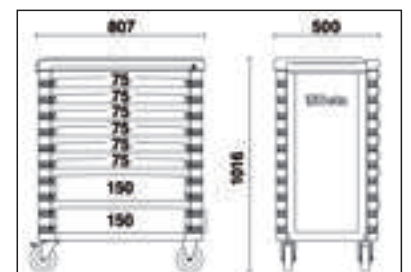
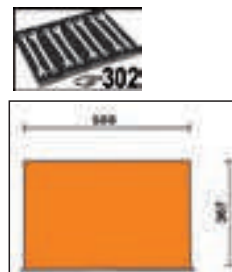

C378-O	1	037000081
C378-G	1	037000082
C378-R	1	037000083

3700/PLA

stainless steel worktop for mobile roller cab item C37

2,8 kg

3700/PLA 1 037000100



672x396x1,5 mm

3700/PLL

wood worktop for mobile roller cab item C37

3,9 kg

3700/PLL 1 037000101



672x396x28 mm

3700/PF

perforated panel with brackets for mobile roller cab item C37

3,2 kg

3700/PF 1 037000102

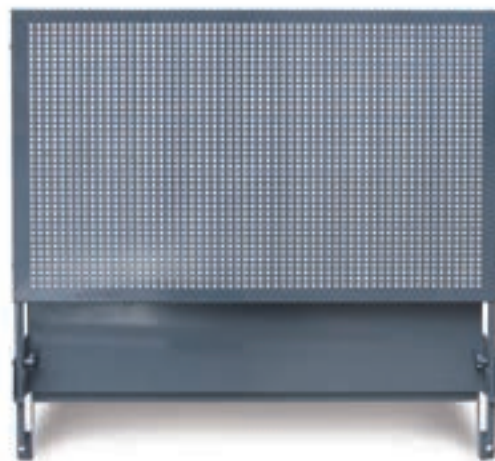

626
80
650



3700/PFL

perforated side panel for mobile roller cab item C37

1,9 kg

3700/PFL 1 037000104



754
32
321



3700/PC

computer bracket for mobile roller cab item C37

3,1 kg

3700/PC 1 037000103

303
300
418



C38

mobile roller cab
with eleven drawers

Main features:

- Eleven drawers with ball bearing slides:
- 1 drawer 937x410x122 mm
- 3 drawers 570x410x74 mm
- 2 drawers 570x410x153 mm
- 3 drawers 313x410x74 mm
- 2 drawers 313x410x153 mm.
- Drawer bases protected by foamed rubber mats.
- Static load capacity: 1200 kg.
- 4 high-capacity castors: Ø 125 mm:
- 2 fixed and 2 steering (both with lever brake).
- Front centralized lock.
- Sheet metal worktop covered by a rubber mat.
- Can be fitted with paper roll holder item 2499PC and bottle holder item 2499PF.

114 kg

C38-O	1	038000001
C38-G	1	038000003
C38-R	1	038000002



C38-G

C38-R

C38-O



h	max
74 mm	25 kg
153 mm	30 kg

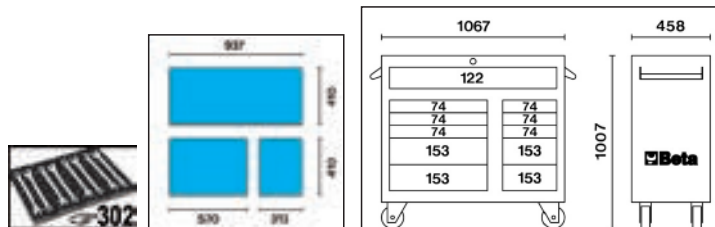

C38L

side cab
with seven drawers

Main features:

- Seven drawers (410x313 mm) with ball bearing slides:
- 5 drawers, 74 mm high
- 2 drawers, 153 mm high
- Drawer bases protected by foamed rubber mats.
- Front centralized safety lock.
- Antislip aluminium worktop.
- Can be placed on both sides of roller cab C38 and C38A.

45 kg

C38L-O	1	038000081
C38L-G	1	038000083
C38L-R	1	038000082



C38L-O

C38L-G

C38L-R

h	max
74 mm	25 kg
153 mm	30 kg

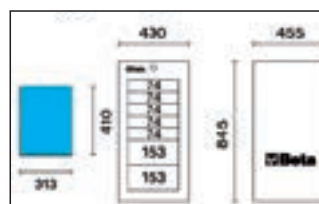

C38L A

side door
with interior shelf

Main features:

- Front lock.
- Vertically adjustable interior shelf.
- Inside door document pocket.
- Antislip aluminium worktop.
- Can be placed on both sides of roller cab C38.

18 kg

C38LA O	1	038000071
C38LA G	1	038000073
C38LA R	1	038000072



C38LA-O

C38LA-G

C38LA-R

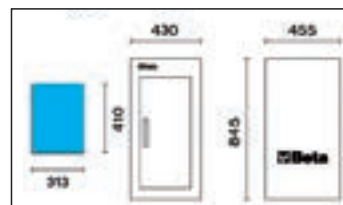

C38C

- mobile roller cab
with thirty three drawers,
comprising:
- 1 mobile roller cab C38
 - 2 side cabs C38L
 - 1 cab C38T with top chest

268 kg



C38C-O



C38C-G



C38C-R



h	max
74 mm	25 kg
153 mm	30 kg

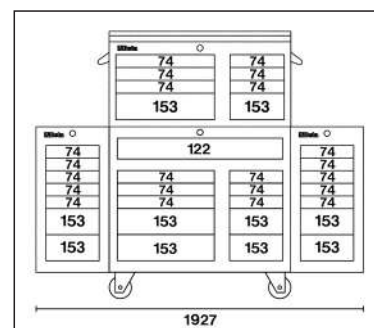
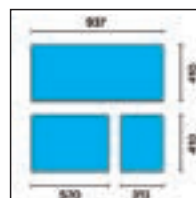

C38C-O	1	038000201
C38C-G	1	038000203
C38C-R	1	038000202

C38T

- cab
with eight drawers and top chest

Main features:

- Eight drawers with ball bearing slides:
 - 3 drawers 570x410x74 mm
 - 1 drawer 570x410x153 mm
 - 3 drawers 313x410x74 mm
 - 1 drawer 313x410x153 mm.
- Tool compartment.
- Drawer bases protected by foamed rubber mats.
- Front centralized safety lock.
- Antislip aluminium worktop.
- Can be placed on roller cab C38 and C38A.

64 kg



C38T-O



C38T-G



C38T-R

h	max
74 mm	25 kg
153 mm	30 kg

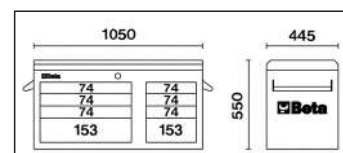

C38T-O	1	038000091
C38T-G	1	038000093
C38T-R	1	038000092

C39/6

mobile roller cab with six drawers

Main features:

- Six drawers (588x367 mm) with ball bearing slides:
 - 4 drawers, 70 mm high
 - 1 drawer, 140 mm high
 - 1 drawer, 280 mm high
- Drawer bases protected by foamed rubber mats.
- Four castors 125 mm in Ø:
 - 2 fixed and 2 steering (one with brake).
- Front centralized safety lock.
- Opening system throughout length of drawer.
- Static load capacity: 1200 kg.
- Thermoplastic worktop.
- Integrated side and rear bottle holders.
- Integrated paper roll holder.
- Uprights and drawer front made of aluminium.

 **1200 kg**



 **59 kg**

h	max
70 mm	30 kg
140 mm	35 kg
280 mm	40 kg

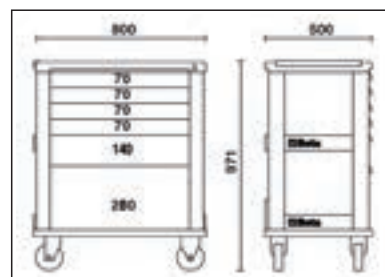

C39-6/O	1	039000031
C39-6/G	1	039000032
C39-6/R	1	039000033

C39T

portable tool chest
with four drawers

Main features:

- Four drawers (588x367 mm) with ball bearing slides:
 - 4 drawers, 70 mm high
- Front centralized safety lock.
- Uprights and drawer front made of aluminium.



h	max
70 mm	30 kg



 **29 kg**

C39T-O	1	039000101
C39T-G	1	039000102
C39T-R	1	039000103

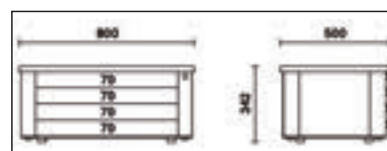

C39/7

roller cab
with seven drawers

Main features:

- Seven drawers (588x367 mm) with ball bearing slides:
- 5 drawers, 70 mm high
- 1 drawer, 140 mm high
- 1 drawer, 210 mm high.
- Drawer bases protected by foamed rubber mats.
- Four castors 125 mm in Ø:
- 2 fixed and 2 steering (1 with brake).
- Front centralized safety lock.
- Opening system throughout length of drawer.
- Static load capacity: 1000 kg.
- Thermoplastic worktop.
- Integrated side and rear bottle holders.
- Integrated paper roll holder.
- Uprights and drawer front made of aluminium.

61 kg

1200
kg



C39-7/O



C39-7/G



C39-7/R

h	max
70 mm	30 kg
140 mm	35 kg
210 mm	35 kg

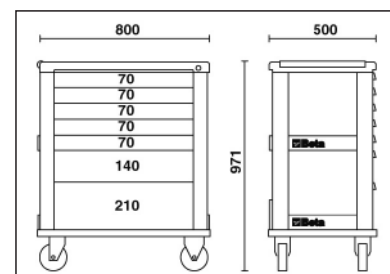

C39-7/O	1	039000001
C39-7/G	1	039000002
C39-7/R	1	039000003

C39/8

mobile roller cab with eight drawers

Main features:

- Eight drawers (588x367 mm) with ball bearing slides:
- 6 drawers, 70 mm high
- 2 drawers, 140 mm high
- Drawer bases protected by foamed rubber mats.
- Four castors 125 mm in Ø:
- 2 fixed and 2 steering (one with brake).
- Front centralized safety lock.
- Opening system throughout length of drawer.
- Static load capacity: 1200 kg.
- Thermoplastic worktop.
- Integrated side and rear bottle holders.
- Integrated paper roll holder.
- Uprights and drawer front made of aluminium.

1200
kg



C39-8/O



C39-8/G



C39-8/R

 64 kg

h	max
70 mm	30 kg
140 mm	35 kg

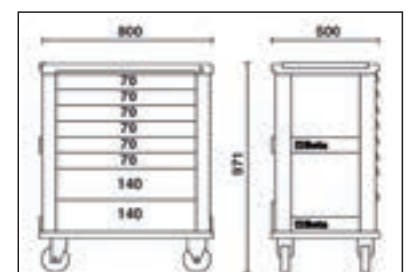

C39-8/O	1	039000041
C39-8/G	1	039000042
C39-8/R	1	039000043

2200-COVER C22S

Nylon cover for portable tool chest item C22S



2200-COVER C22S

1 022000910

2300-COVER C23S

Nylon cover for portable tool chest item C23S



2300-COVER C23S

1 023000920

2300-COVER C23ST

Nylon cover for portable tool chest item C23ST



2300-COVER C23ST

1 023000930

2400-COVER C24S

Nylon cover for mobile roller cabs items C24S/SA - C39



2400-COVER C24S

1 024000910

2400-COVER C24SA-XL

Nylon cover for mobile roller cab item C24SA-XL



2400-COVER C24SA-XL

1 024000930

3700-COVER C37

Nylon cover for mobile roller cab item C37



3700-COVER C37

1 037000930

4100-COVER C41H

Nylon cover for tool trolley item C41H



4100-COVER C41H

1 041000930

C39SM

special mobile roller cab, Racing SM type

Specifications

- Multi-ply wood worktop
- 4 castors, Ø 125 mm
- 2 fixed and 2 steering (one with brake), with exposed covering
- Static load capacity: 1200 kg

7-drawer module

588x367 mm, with ball bearing slides:

- 6 drawers, 70 mm high
- 1 drawer, 240 mm high
- Drawer bases protected by foamed rubber mats
- Front centralized safety lock
- Opening system throughout length of drawer
- Drawer front made of aluminium

Service module

- Integrated wastepaper basket
- Paper roll compartment
- 1 large drawer (420x305x270 mm)

1200
kg



C39SM-O



h	max
70 mm	30 kg
240 mm	40 kg

125 kg

Model	Qty	Code
C39SM-O	1	039390001
C39SM-G	1	039390002
C39SM-R	1	039390003

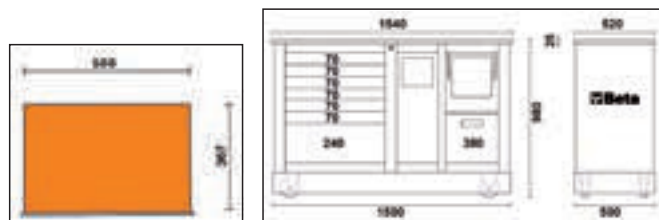

C39MD

special mobile roller cab, Racing MD type

Specifications

- Multi-ply wood worktop
- 4 castors, Ø 125 mm
- 2 fixed and 2 steering (one with brake), with exposed covering
- Static load capacity: 1200 kg

7-drawer module

588x367 mm, with ball bearing slides:

- 6 drawers, 70 mm high
- 1 drawer, 240 mm high
- Drawer bases protected by foamed rubber mats
- Front centralized safety lock
- Opening system throughout length of drawer
- Drawer front made of aluminium

2-drawer module

588x367x270 mm and 588x367x380 mm, with ball bearing slides

- Drawer bases protected by foamed rubber mats
- Front centralized lock
- Opening system throughout length of drawers
- Drawer front made of aluminium

1200
kg

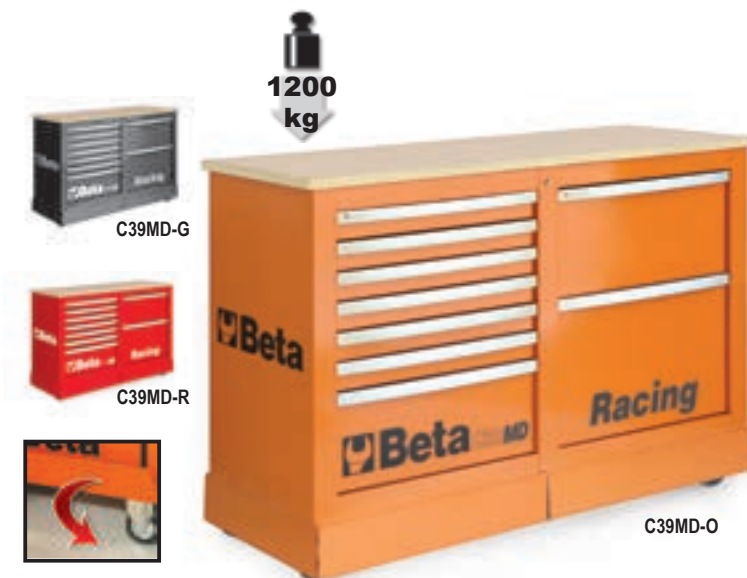

h	max
70 mm	30 kg
240 mm	40 kg

123 kg

Model	Qty	Code
C39MD-O	1	039390101
C39MD-G	1	039390102
C39MD-R	1	039390103

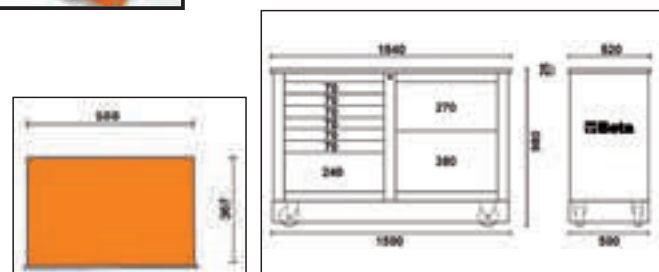

C41S

two-module tool trolley

Main features:

- Sheet metal frame and plastic tops, synonymous with remarkable sturdiness and reduced weight.
- 2 detachable modules:
 - 1 upper tool box,
 - 1 module with 2 drawers, 95 mm and 295 mm high respectively.
- Oversized castors (160 mm), built into frame for easy transport - for example, on steps.
- Side centralized lock
- for closing drawers of lower module.
- Drawers with ball bearing slides and double closing hook.
- Telescopic aluminium handle.
- Small tool holder built into upper tool box.
- Lower drawer with double ballbearing slide

Recommended assortments: 5940/SBK and 5915VU/5

16 kg

C41S

1 041000001

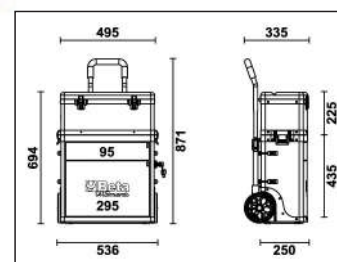

C41H

two-module tool trolley

Main features:

- Sheet metal frame and plastic tops, synonymous with remarkable sturdiness and reduced weight.
- 2 detachable modules:
 - 1 upper tool box,
 - 1 module with 2 drawers 95 mm in height,
 - 1 pull-out case made of plastic, 66 mm high, and 1 drawer 295 mm in height.
- Oversized castors (160 mm), built into frame for easy transport - for example, on steps.
- Side centralized lock for closing drawers of lower module.
- Drawers with ball bearing slides and double closing hook.
- Telescopic aluminium handle.
- Small tool holder built into upper tool box.
- Lower drawer with double ballbearing slide

Recommended assortments: 5941VU/M, 5940/SBK and 5915VU/5

* Colours available on request

21 kg

Model	Color	Weight	Part No.
C41H-O	RAL 2011	1	041000002
C41H-N	RAL 9005	1	041000005
C41H-B	RAL 5002	1	041000006
C41H-R	RAL 3000	1	041000008
C41H-G	RAL 7016	1	041000010
C41H-Y	RAL 1023	1	041000012
C41H-W	RAL 9016	1	041000021
C41H-V	RAL 6016	1	041000024



C41H-O



C41H-W

C41H-Y

C41H-R

C41H-V

C41H-B

C41H-G

C41H-N

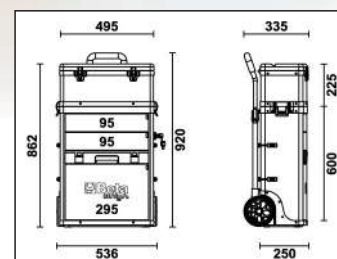

C42S

two-module tool trolley

Main features:

- Sheet metal frame and plastic tops, synonymous with remarkable sturdiness and reduced weight.
- 2 detachable modules:
 - 1 upper tool box, 220 mm high
 - 1 lower tool module with castors, 330 mm high.
- Oversized castors (ø 160 mm).
- Telescopic handle, can be adjusted in 3 positions
- Quick module release system: easy, quick access to all compartment tools.
- Upper tool box with interior object compartment and 3 tool trays built into cover.

Recommended assortments: 5940/SBK and 5915VU/5

11,5 kg

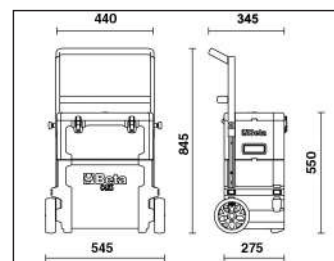

C42S

1 042000001

C42H

three-module tool trolley

Main features:

- Sheet metal frame and plastic tops, synonymous with remarkable sturdiness and reduced weight.
- 3 detachable modules:
 - 1 upper tool box, 220 mm high
 - 1 central tool module, 180 mm high.
 - 1 lower tool module with castors, 330 mm high.
- Oversized castors (ø 160 mm).
- Telescopic handle, can be adjusted in 3 positions
- Quick module release system: easy, quick access to all tool compartments.
- Upper tool box with interior object compartment and 3 tool trays built into cover.
- Can be used with 2 modules.

Recommended assortments: 5940/SBK and 5915VU/5

14 kg

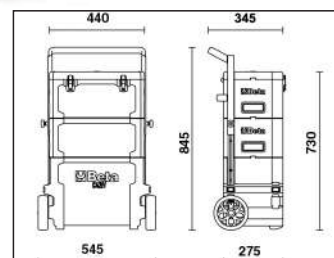

C42H

1 042000002

C41MS

upper module
with built-in small tool holder

3 kg

C41MS	RAL 2011	1	041000904
C41MS/N	RAL 9005	1	041000922
C41MS/B	RAL 5002	1	041000932
C41MS/R	RAL 3000	1	041000942
C41MS/G	RAL 7016	1	041000952
C41MS/Y	RAL 1023	1	041000962
C41MS/W	RAL 9016	1	041000972
C41MS/V	RAL 6016	1	041000982



495x250x225 mm

C41H/CE

tool chest
with removable partitions for small tools,
made from plastic material

1,3 kg

C41H/CE		1	041000916
---------	--	---	-----------



C42 MCH

additional central module for tool trolley item C42

2,5 kg

C42MCH		1	042000105
--------	--	---	-----------



440x180x275 mm



Beta

C43

three-module tool trolley

Main features:

- Sheet metal frames and plastic tops
- 3 detachable modules:
 - 1 upper tool box, 222 mm high
 - 1 central module, 168 mm high, with 2 drawers, 60 mm high
 - 1 lower module, 332 mm high, with up-and-over door, 280 mm high, with castors
- Castors \varnothing 128 mm
- Telescopic handle, can be adjusted in 4 positions
- Module release system with access to all tool compartments
- Upper tool box with removable interior object compartment and 2 tote-trays built into cover

15,5 kg

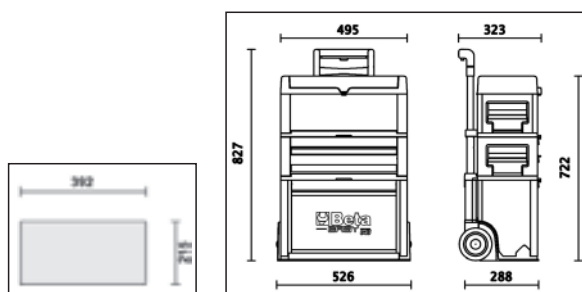

CX49-G

multi-purpose trolley

can be used as a mobile workstation for diagnostic tools, laptops, testers and battery chargers.

SPECIFICATIONS

- Painted sheet metal frame: unparalleled firmness and sturdiness
- Ergonomic handle
- 2-level top
- Pull-out drawer for housing a mini keyboard
- 2 central shelves with adjustable position and 1 fixed low shelf
- 4 useful side cable reels made of plastic - 2 useful side containers
- 2 fixed rear castors Ø 160 mm
- 2 steering front castors Ø 125 mm (one with brake)
- Weight: 36 kg



CX49

1 049000102

CA49-G

multi-purpose trolley with door

can be used as a mobile workstation for diagnostic tools, laptops, testers and battery chargers.

SPECIFICATIONS

- Painted sheet metal frame: unparalleled firmness and sturdiness
- Ergonomic handle
- 2-level top
- Pull-out drawer for housing a mini keyboard
- 1 shelf with adjustable position, 1 fixed shelf and door
- 4 useful side cable reels made of plastic
- 2 useful side containers
- 2 fixed rear castors Ø 160 mm
- 2 steering front castors Ø 125 mm (one with frame)
- Weight: 36.5 kg



CA49 G

1 049000112

C51

trolley

- 3 tops covered in antislip ribbed rubber
- Ergonomic handle
- Two fixing options for central worktop
- Four castors Ø 100 mm:
2 fixed and 2 steering (1 with brake)
- Static load capacity: 200 kg (distributed between 3 shelves)

📦 21 kg

C51 O	1	051000001
C51 G	1	051000002
C51 R	1	051000003

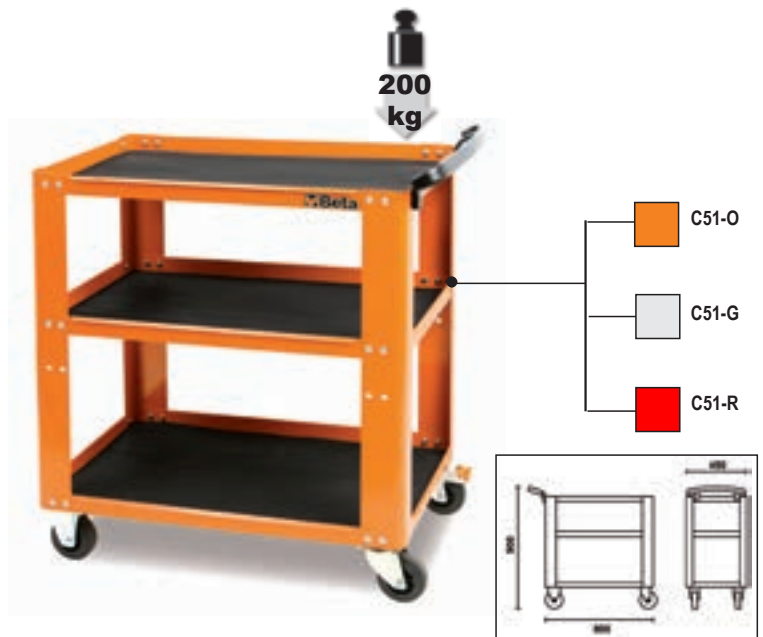

CP51

high-grade trolley

- 2 tops covered with rubber mats
- Ergonomic handle
- Four high-grade castors Ø 125 mm:
2 fixed and 2 steering (one with brake).
- Static load capacity: 750 kg (shared by 2 tops)

📦 37 kg

CP51 O	1	051000501
CP51 G	1	051000502
CP51 R	1	051000503

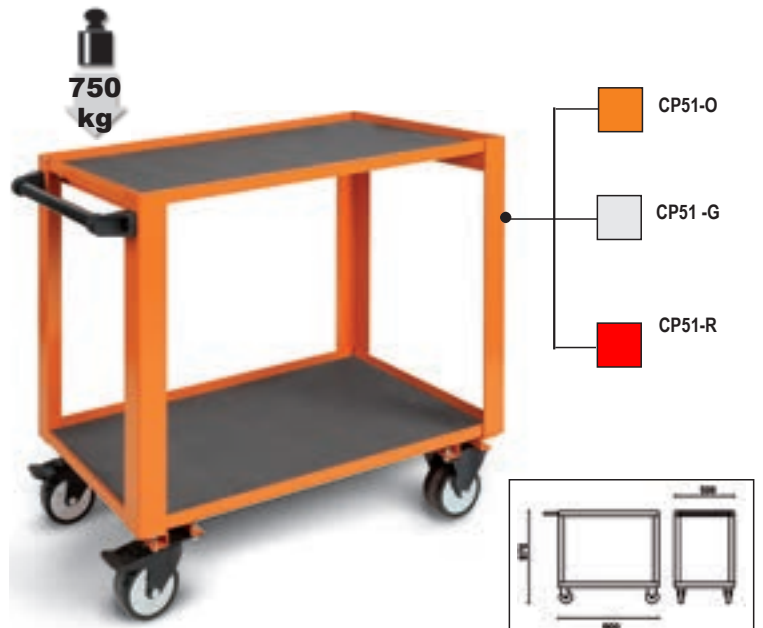

CB52

gearbox/transmission trolley with liquid recovery system

Inclined plane and drain holes allow liquids to be recovered in collection tank

Fitted with:

- 4 swivel castors, including 2 with brakes
- tool drawer
- pull-out liquid collection tank; capacity: 7 l
- 2 shelves

Dimensions: 1200x640x870 mm
Weight: 60 kg

📦 60 kg

CB52	1	052000201
------	---	-----------



C54S

Cargo tool cabinets

These tool cabinets are designed according to detailed research and offer accurate, comfortable and rational solutions for end users.

Two perforated panels attached to the doors may be opened giving access to additional storage space.

Main features:

- 1 drawer, with slides.
- Easy tool layout according to users' needs.
- Easy wall mounting by means of two slots located at the back of the cabinet .
- Safety lock for both drawers and doors.
- Empty thermoformed tray for 1/2" sockets and accessories

📦 37 kg

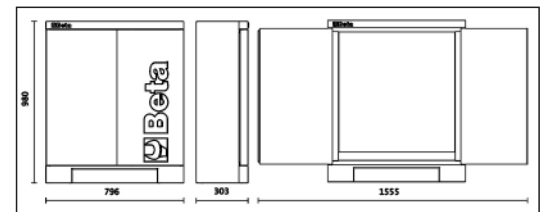

C54S-O	1	054000301
C54S-G	1	054000302
C54S-R	1	054000303

C56P O

folding workbench

Compact and easy to carry.
30-mm-thick worktop made of MDF and galvanized sheet iron; can be used on both sides.
Handle with rubber protection for easy transport.

Feet with anti-slip coating.
Static load capacity: 250 kg.

📦 25 kg



C56P O	1	056000011
--------	---	-----------

C57SA

MasterCargo workbench

- Model with tool storage board (C57P) and one drawer cabinet.

Drawer cabinet: five drawers, 588x367 mm, 3 90 mm high, 1 180 mm and 1 280 mm high, with ball bearing slides. Can accommodate thermoformed trays. Centralized lock.

Panel tool holder with holes on back for wall mounting. Vertically operated aluminium shutter, with lock. Three removable perforated panels for supporting tools.

Multi-ply worktop, coated in plastic laminate with three holes for vice item 1599F/150, to be ordered separately.



C57SA O

📦 205 kg



C57SA G



C57SA R



5700SA O



h	max
90 mm	30 kg
180 mm	40 kg
280 mm	40 kg

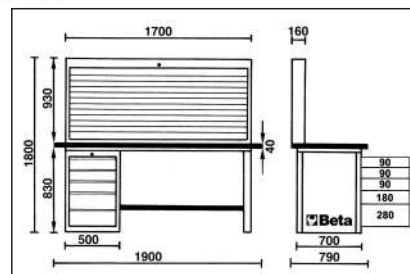

C57SA-O	1	057001005
C57SA-G	1	057001205
C57SA-R	1	057001405

C57SD

MasterCargo workbench

- Model with one drawer cabinet

Drawer cabinet: five drawers, 588x367 mm, 3 90 mm high, 1 180 mm and 1 280 mm high, with ball bearing slides. Can accommodate thermoformed trays. Centralized lock.

Multi-ply worktop, coated in plastic laminate with three holes for vice item 1599F/150, to be ordered separately.



C57SD O



h	max
90 mm	30 kg
180 mm	40 kg
280 mm	40 kg



C57SD G



C57SD R

📦 158 kg

C57SD-O	1	057001004
C57SD-G	1	057001204
C57SD-R	1	057001404

C57SB

MasterCargo workbench

- Model with tool storage board (C57P) and two drawer cabinets.

Drawer cabinet: five drawers, 588x367 mm, 3 90 mm high 1 180 mm and 1 280 mm high, with ball bearing slides.

Can accommodate thermoformed trays
Centralized lock.

Panel tool holder with holes on back for wall mounting.
Vertically operated aluminium shutter, with lock.
Three removable perforated panels for supporting tools.

Multi-ply wood worktop, coated in plastic laminate with three holes for vice item 1599F/150, to be ordered separately.

243 kg



C57S B O



C57S B G



C57S B R



5700S B O



h	max
90 mm	30 kg
180 mm	40 kg
280 mm	40 kg

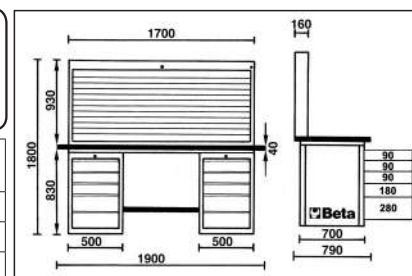

C57S/B-O	1	057001006
C57S/B-G	1	057001206
C57S/B-R	1	057001406

C57SC

MasterCargo workbench

- Model with two drawer cabinets.

Drawer cabinet: five drawers, 588x367 mm, 3 90 mm high 1 180 mm and 1 280 mm high, with ball bearing slides.

Can accommodate thermoformed trays.
Centralized lock.

Multi-ply wood worktop, coated in plastic laminate with three holes for vice item 1599F/150, to be ordered separately.

196 kg



C57SC O



h	max
90 mm	30 kg
180 mm	40 kg
280 mm	40 kg



C57SC G



C57SC R

C57S/C-O	1	057001003
C57S/C-G	1	057001203
C57S/C-R	1	057001403

C57SP

panel tool holder

Panel tool holder with two holes on back for wall mounting.
Aluminium shutter, vertically adjustable, with lock.
Three removable perforated panels for tool holding.

46 kg

C57SP-O	1	057001020
C57SP-G	1	057001220
C57SP-R	1	057001420



C57SP O

1700 mm

930 mm



C57SP G



C57SP R

5700LAMP

MasterCargo workbench lamp

- Sturdy sheet metal frame comprising four elements; provided with screws for assembling the lamp.
- Lamp holder with 1120-Lumen LED strip, 4000K, 14W.
- Power supply 230V.
- Provided without wire.

9 kg

5700 LAMP	1	057000005
-----------	---	-----------



5700LAMP + 5700SA O

C58P

panel toolholder

- Security locked shutter.
- Two removable perforated panels for tool holding.

31 kg

C58P-O	1	058000121
C58P-G	1	058000122
C58P-R	1	058000123



C58P G



C58P R



C58P O

1200 mm

930 mm

PV

wall tool panel

	LxA mm	kg		
PV1	1000x920	10,2	1	088880010
PV1,5	1500x920	14,2	1	088880015



A

L

C56W

workbench with wood top

- Multi-ply wood worktop (30 mm thick)
- Steel frame with 6 supporting legs
- Static load capacity: 1,200 kg
- Matches panel tool holder C57P; cannot be fixed to worktop.
- Two drawers with locks.
- Can be fixed to floor.

86 kg



C56W-O	1	056000251
C56W-G	1	056000252
C56W-R	1	056000253

C56

workbench

- Worktop made of painted sheet metal with external edge
- Steel frame with 6 supporting legs
- Static load capacity: 1200 kg
- Matches panel toolholder C57P; cannot be fixed to worktop
- Two drawers with lock
- Can be fixed to floor

82 kg



C56-O	1	056000201
C56-G	1	056000202
C56-R	1	056000203

C56M

workbench

- Worktop made from both slip-proof aluminium sheet and rubber mat.
- Load capacity: kg.800.
- Can match panel toolholder C57P.
- Three drawers with lock.
- Can be fixed to the floor.

95 kg

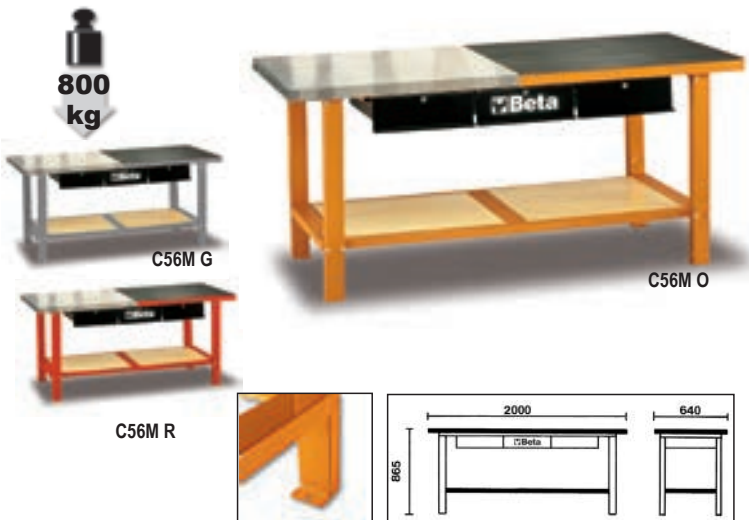

C56M O	1	056000050
C56M G	1	056000053
C56M R	1	056000054

C58M

workbench

- Metal worktop fully covered with a removable antislip rubber mat.
- Lower shelf made from solid wood.
- Static load capacity: 800 kg.
- Can match panel tool holder C58P; cannot be fixed to the worktop.
- 2 drawers with locks.
- Can be fixed to the floor.
- Aluminium worktop item C58M/PA available on request.

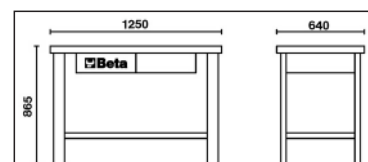

📦 65 kg

	📦	🏠
C58M-O	1	058000300
C58M-G	1	058000302
C58M-R	1	058000303

C58M/PA

knurled aluminium worktop for workbench item C58M

📦 4,5 kg



	📦	🏠
C58M/PA	1	058000350

C59A

"Endurance" workbench with 1 cab with six drawers

Main features:

- Worktop made from multi-ply wood with holes for vice item 1599F/125 (to be ordered separately).
- 6 drawers (588x367 mm) with ball bearing slides:
 - 4 drawers, 70 mm high
 - 1 drawer, 140 mm high
 - 1 drawer, 280 mm high.
- Drawers protected by foamed rubber mats.
- Hard-wearing nylon drawer front.
- Roller cabs can accommodate thermoformed trays.
- Front centralized safety lock.
- Lower object shelf.
- Can be fitted with paper roll holder (2400S-R/PC) and bottle holder (2400S/PF), to be ordered separately.

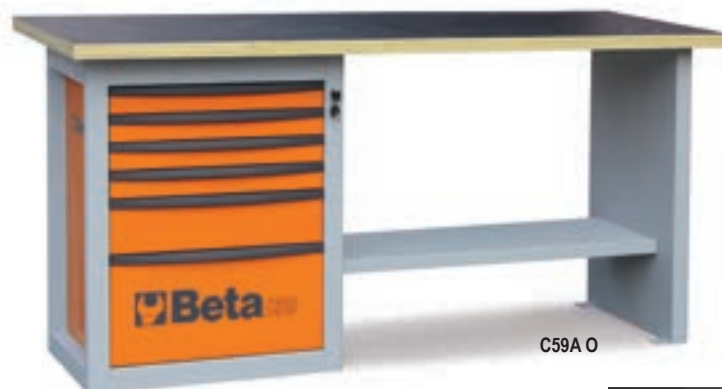

C59A O



📦 115 kg

	📦	🏠
C59A-O	1	059000001
C59A-G	1	059000021
C59A-R	1	059000041



C59A G

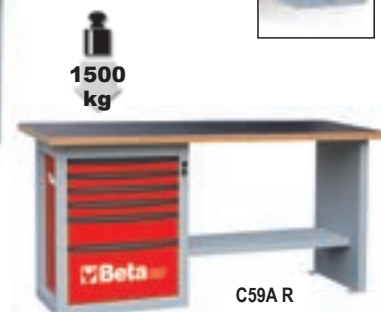

C59A R



h	max
70 mm	25 kg
140 mm	30 kg
280 mm	35 kg

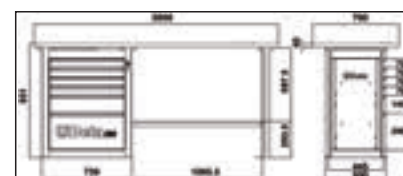



C59B

"Endurance" workbench with 2 cabs with six drawers

Main features:

- Worktop made from multi-ply wood with holes for vice item 1599F/125 (to be ordered separately).
- 12 drawers (588x367 mm) with ball bearing slides:
8 drawers, 70 mm high
2 drawers, 140 mm high
2 drawers, 280 mm high.
- Drawers protected by foamed rubber mats.
- Can accommodate thermoformed trays.
- Front centralized safety lock.
- Lower object shelf.
- Can be fitted with paper roll holder (2400S-R/PC) and bottle holder (2400S/PF), to be ordered separately.

155 kg

		
C59B-O	1	059000002
C59B-G	1	059000022
C59B-R	1	059000042

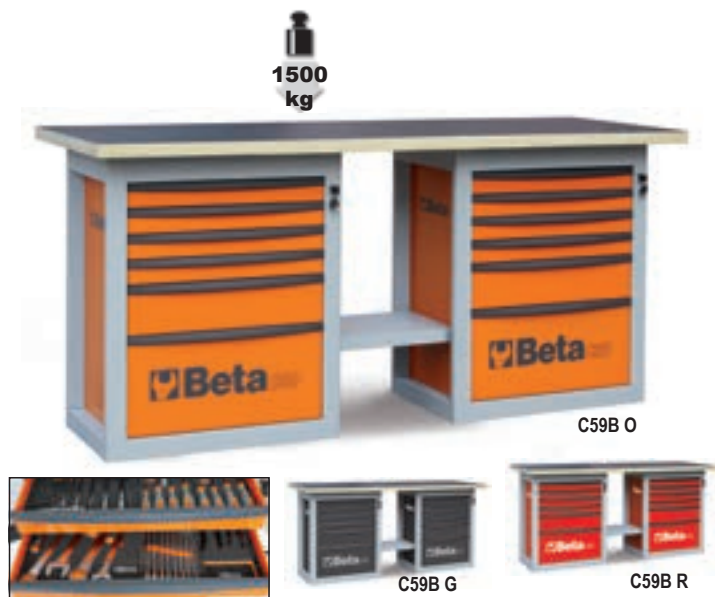

h	max
70 mm	25 kg
140 mm	30 kg
280 mm	35 kg

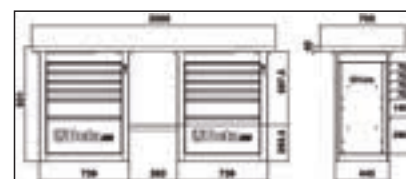



C59C

"Endurance" workbench with 1 cab with six drawers, short model

Main features:

- Worktop made from multi-ply wood with holes for vice item 1599F/125 (to be ordered separately).
- 6 drawers (588x367 mm) with ball bearing slides:
4 drawers, 70 mm high
1 drawer, 140 mm high
1 drawer, 280 mm high.
- Drawers protected by foamed rubber mats.
- Can accommodate thermoformed trays.
- Front centralized safety lock.
- Lower object shelf.
- Can be fitted with paper roller holder (2400S-R/PC) and bottle holder (2400S/PF), to be ordered separately.

105 kg

		
C59C-O	1	059000003
C59C-G	1	059000023
C59C-R	1	059000043

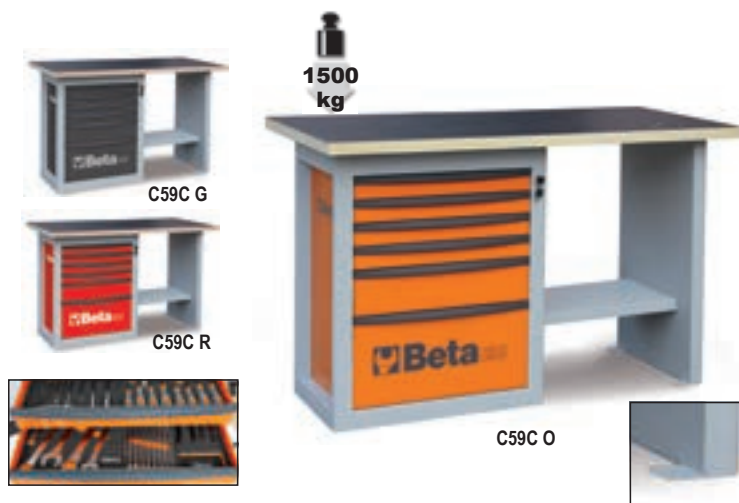

h	max
70 mm	25 kg
140 mm	30 kg
280 mm	35 kg

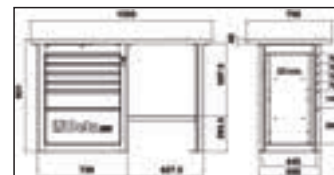

9562T2

workbench mat, 200x160 cm

- protects floor from oil and petrol leaks, environmentally friendly
- easy to clean, anti-skid, rubber-coated bottom



9562T2

		
	1	095620200



WORKSHOP EQUIPMENT

To answer the requirements of a market where the emphasis is increasingly on quality, design and customization, Beta Utensili has developed "Racing System C55", modular garage furniture shaped on your needs, while allowing you to create a modern work environment.

Quality

Beta's best Italian-made quality to furnish your garage

Modularity

Modular garage fitting your spaces and requirements

Organization

A sensibly organized workstation, synonymous with optimized work

Design

Refined, captivating finishes for a tidy, attractive workstation

MADE IN ITALY

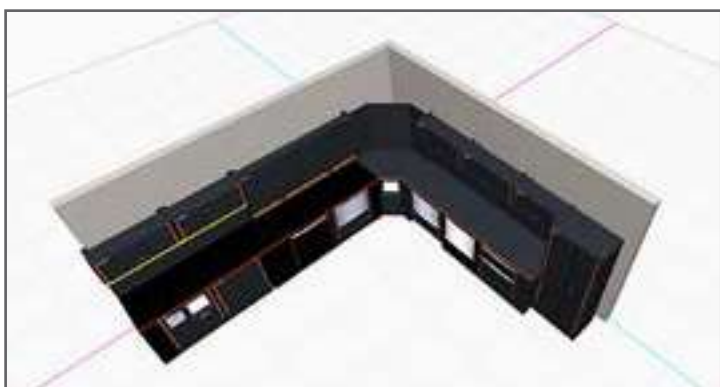

Configure your workshop online

Go to **www.rsc55.com**



Your colours for your workshop!

RSC55 allows you to order the benches and tool wall system with shutter in a neutral (grey) version and customize the vertical coloured inserts by choosing from 7 different adhesive tapes.

1. Order the vertical insert in a neutral colour

2. Order the vertical insert

Choose the colour to your taste or according to your company's colours



Comprehensive combination comprising:

- Single-door tool cabinet (C55A1)
- Two-door tool cabinet (C55A2)
- Workbench (C55BO/2)
- Workbench with sockets (C55PRO BO/2)
- Mobile roller cab with 7 drawers (C55C7)
- Fixed module with 2 storage drawers (C55M2)
- Fixed module with 7 drawers (C55M7)
- Fixed service module (C55MS)
- Tool panel with suspended cabinets (C55/2PM)
- Tool panel with shutter (C55PS-O)

C55AB

workshop equipment combination

Combination comprising:

- Two-door tool cabinet (C55A2)
- Workbench (C55BO/2)
- Fixed module with 7 drawers (C55M7)
- Fixed service module (C55MS)
- Tool panel with suspended cabinets (C55/2PM)

407 kg



C55AB

1 055000020



C55PB/3

workshop equipment combination

Combination comprising:

- Workbench (C55BO/2)
- Fixed module with 8 drawers (C55M8)
- Fixed module with 2 storage drawers (C55M2)
- Wall tool system with shutter (C55PS-O)

334 kg



C55PB/3

1 055000035



C55B/2

2-m-long workbench, for workshop equipment combination

With worktop (2050x700 mm) covered with a shockproof, non-scratch PVC coat, resistant to hydrocarbons

- Holes for a vice (1599F/150, to be ordered separately)
- Vertically adjustable feet

105 kg

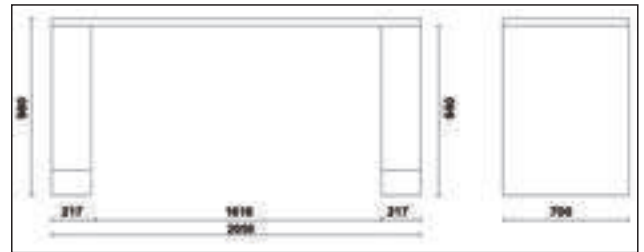

C55BO/2	1	055000101
C55BG/2	1	055000111

C55PRO B/2

2-m-long workbench, for workshop equipment combination

With worktop (2050x700 mm) covered with a shockproof, non-scratch PVC coat, resistant to hydrocarbons

Built-in sockets and roller:

- Schuko socket+16+10A
- Plug +10A
- Compressed air outlet and roller, Ø 8 mm. Length: 10 m
- Holes for a vice (1599F/150, to be ordered separately)
- Vertically adjustable feet

110 kg

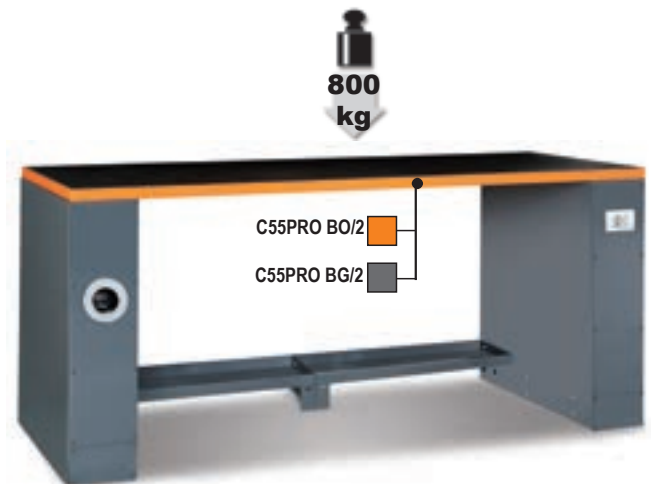

C55PRO BO/2	1	055000151
C55PRO BG/2	1	055000171

C55B/2,8

2.8-m-long workbench, for workshop equipment combination

Worktop (2850x700 mm) covered with a shockproof, non-scratch PVC coat, resistant to hydrocarbons

- Holes for a vice (1599F/150, to be ordered separately)
- Vertically adjustable feet

129 kg

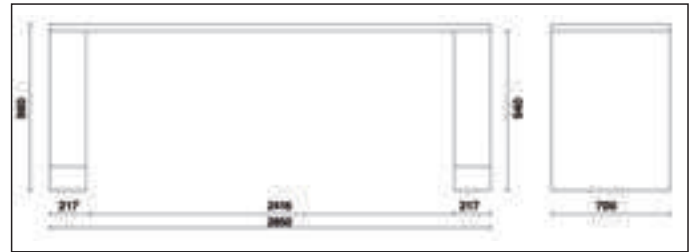
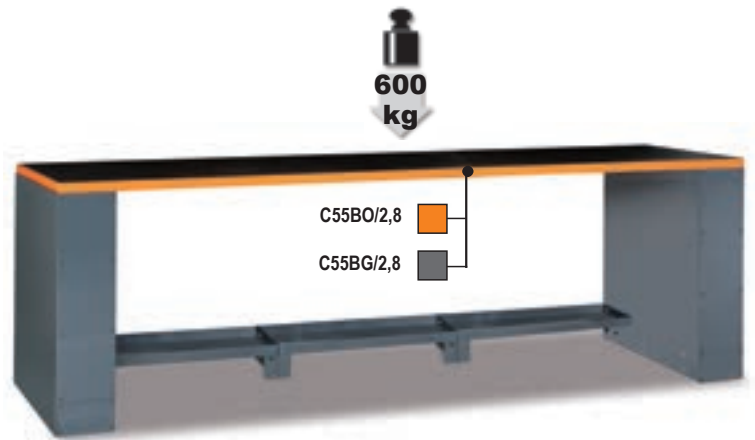

C55BO/2,8	1	055000261
C55BG/2,8	1	055000281

C55PRO B/2,8

2.8-m-long workbench, for workshop equipment combination

Worktop (2850x700) covered with a shockproof, non-scratch PVC-coat, resistant to hydrocarbons

Built-in sockets and roller:

- Schuko socket+16+10A
- Plug +10A
- Compressed air outlet and roller Ø 8 mm. Length: 10 m
- Holes for a vice (1599F/150, to be ordered separately)
- Vertically adjustable feet

134 kg

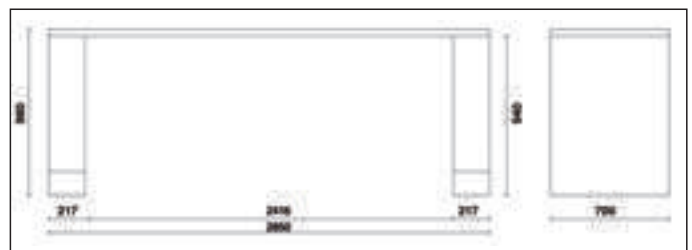
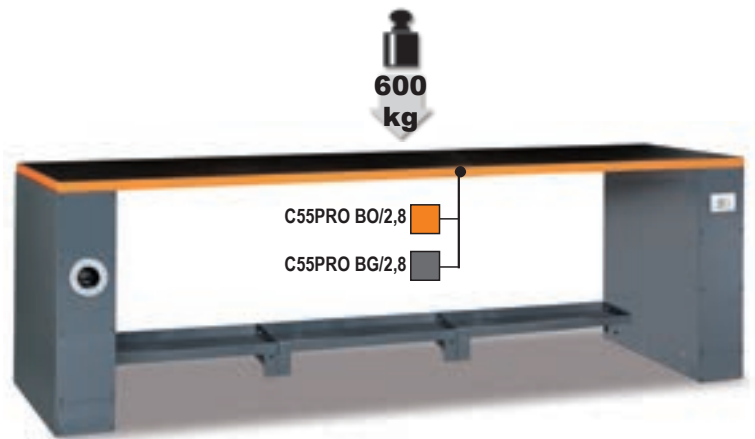

C55PRO BO/2,8	1	055000271
C55PRO BG/2,8	1	055000283

C55B-D4

double 4-m-long workbench with central leg

Worktop (4100x700 mm) covered with a shockproof, non-scratch PVC coat, resistant to hydrocarbons

- Holes for a vice 1599F/150 (to be ordered separately)
- Vertically adjustable feet
- Double central leg with compartment and slide-away door, 350x750 mm

185 kg

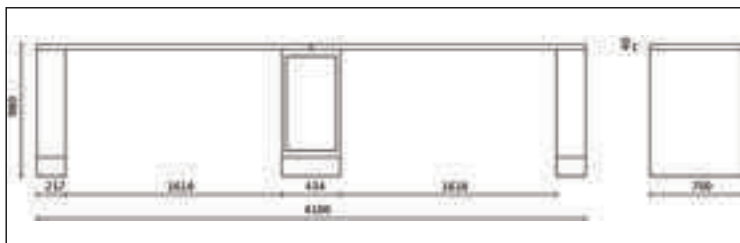
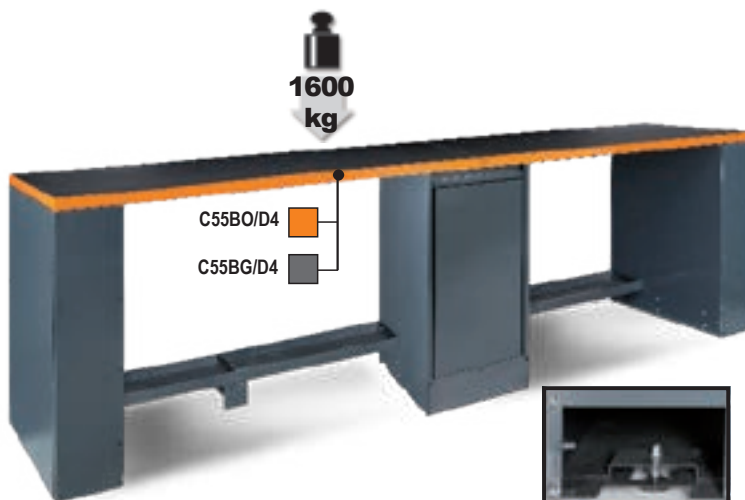

C55BO-D4	1	055000109
C55BG-D4	1	055000119

C55PRO B-D4

double 4-m-long workbench with central leg

With worktop (4100x700) covered with a shockproof, non-scratch PVC coat, resistant to hydrocarbons

Built-in sockets and reel:

- Schuko socket+16+10A
- EU Plug +10A
- Compressed air outlet with reel Ø 8 mm. Length: 10 m
- Holes for a vice 1599F/150 (to be ordered separately)
- Vertically adjustable feet
- Double central leg with compartment and slide-away door, 350x700 mm

190 kg

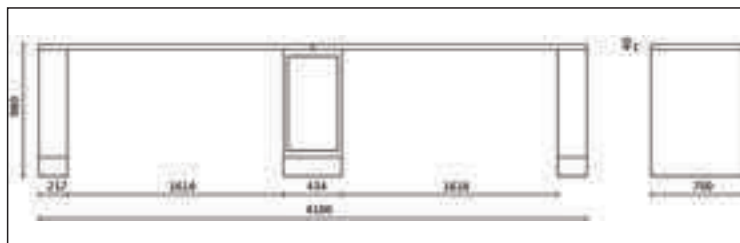
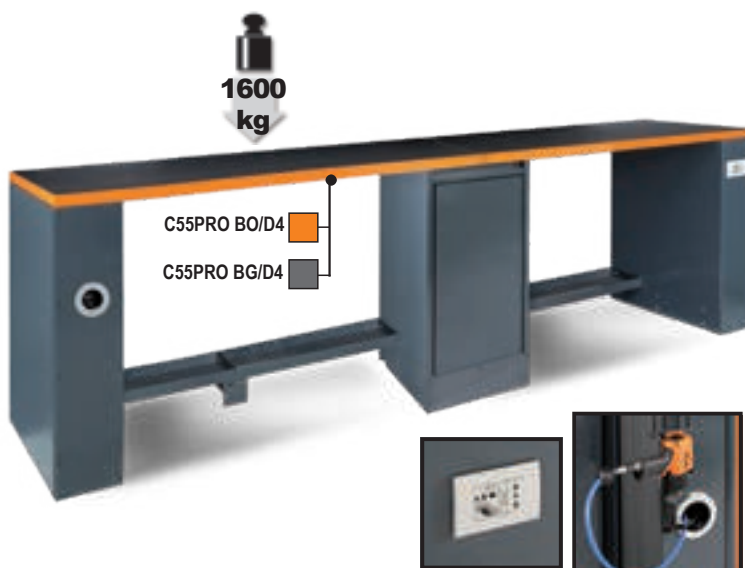

C55PRO-BO-D4	1	055000159
C55PRO-BG-D4	1	055000179

Beta

C55B/G

universal leg for workshop equipment workbench

- With vertically adjustable feet

30 kg

C55B/G

1 055000096

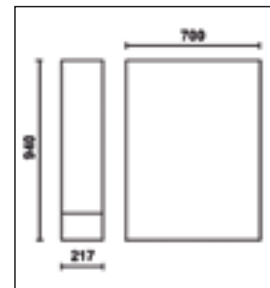

C55B/GAA

universal leg for workbench with built-in hose reel

- Built-in automatic hose reel for compressed air or cold water (Ø 8 mm) item 1901BM/8
- Length: 10 m
- With vertically adjustable feet

35 kg

C55B/GAA

1 055000099

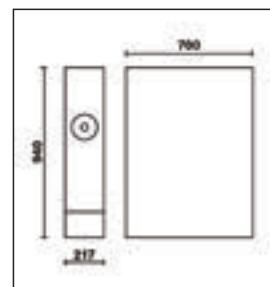
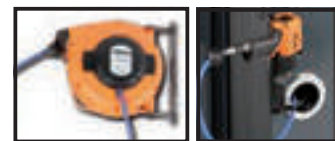

C55B/GDS

double leg for adjoining workshop equipment workbenches

Compartment with slide-away door, 365x750 mm
With vertically adjustable feet

45 kg

C55B/GDS

1 055000291

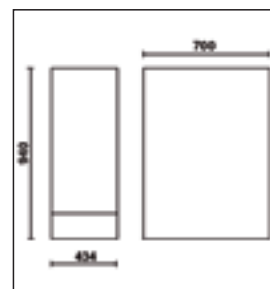

C55B/GE

universal leg with power sockets for workshop equipment workbench

- Schuko socket+16+10A
- EU Plug +10A
- With vertically adjustable feet

30 kg

C55B/GE

1 055000097

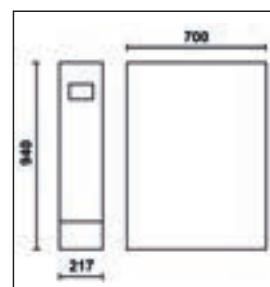

C55B/GAE

universal leg with built-in electrical cable reel for workshop equipment workbench

- Built-in automatic cable reel with Schuko type socket item 1848.
- Length: 15 m
- Thermally protected
- With vertically adjustable feet

35 kg

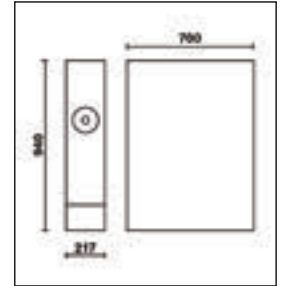

C55B/GAE

1 055000094

C55/PL-1,024

worktop for workshop equipment workbench, 1 m long

- Painted sheet metal worktop (1024x700 mm) covered with a shockproof, non-scratch PVC coat, resistant to hydrocarbons
- With rear crossbar for fixing modules

21 kg

C55/PLO-1,024

1 055000130

C55/PLG-1,024

1 055000131



C55/PLO-1,024

C55/PLG-1,024

C55B PT/2

2-m-long worktop, for workshop equipment workbench

- Painted sheet metal worktop (2050x700 mm) covered with a shockproof, non-scratch PVC coat, resistant to hydrocarbons
- With rear crossbar for fixing modules
- Holes for a vice (1599F/150, to be ordered separately)

43 kg

C55B PT/2

1 055000106

C55BG PT/2

1 055000116

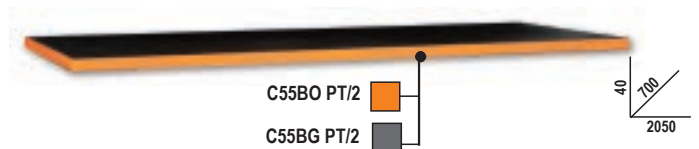

C55BO PT/2

C55BG PT/2

C55B PT/2,8

2.8-m-long worktop, for workshop equipment workbench

- Painted sheet metal worktop (2850x700 mm) covered with a shockproof, non-scratch PVC coat, resistant to hydrocarbons
- With rear crossbar for fixing modules
- Holes for a vice (1599F/150, to be ordered separately)

61 kg

C55BO PT/2,8

1 055000266

C55BG PT/2,8

1 055000286



C55BO PT/2,8

C55BG PT/2,8

C55RB

shockproof, non-scratch PVC coat, resistant to hydrocarbons

For protecting worktop.

C55RB/2: for 2-m-long worktop

C55RB/2.8: for 2.8-m-long worktop

C55RB/0.7: for 700x700mm worktop

C55RB/1: for 1-m-long worktop



C55RB/2	1	055000195
C55RB/2,8	1	055000196
C55RB/0,7	1	055000199
C55RB/1	1	055000198

C55B/VS

lower workbench bracket, 0.8 m long

Dimensions: 800x230x60 mm

4 kg



C55B/VS	1	055000095
---------	---	-----------

C55C7

mobile roller cab with seven drawers, for workshop equipment combination

7 drawers (588x367 mm), with ball bearing slides

- 4 castors Ø 100 mm, 2 fixed (one with brake) and 2 steering
- Aluminium opening system throughout length of drawer
- Drawer bases protected by foamed rubber mats
- Front centralized lock
- Can be fitted with foam trays

79 kg

1000 kg



h	max
70 mm	30 kg
245 mm	40 kg

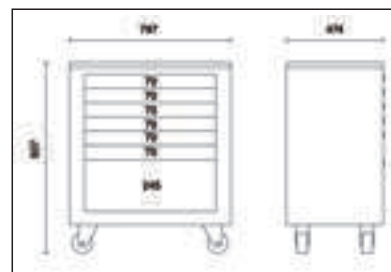

C55C7	1	055000201
-------	---	-----------

C55C8

roller cab module with eight drawers, for workshop equipment combination

- 8 drawers (588x367 mm) with ball bearing slides
- 4 castors Ø 100 mm, 2 fixed (one with brake) and 2 steering
- Aluminium opening system throughout length of drawer
- Drawer bases protected by foamed rubber mats
- Front centralized lock
- Can be fitted with foam trays

81 kg



h	max
70 mm	30 kg
175 mm	40 kg

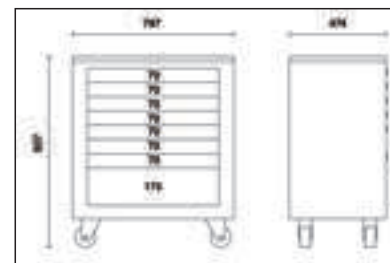

C55C8

1 055000206

C55M2

fixed module with 2 drawers, for workshop equipment combination

- 2 drawers (588x367mm) with ball bearing slides
- Aluminium opening system throughout length of drawer
- Drawer bases protected by foamed rubber mats
- Front centralized lock

66 kg



h	max
280 mm	40 kg
385 mm	40 kg

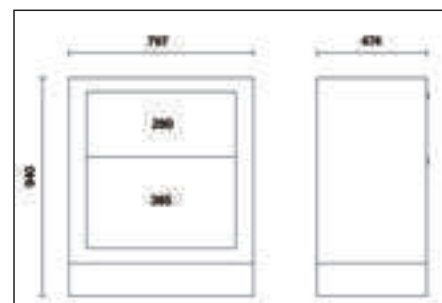

C55 M2

1 055000202

C55M4

fixed module with 4 drawers, for workshop equipment combination

- 4 drawers (588x367 mm) with ball bearing slides
- Aluminium opening system throughout length of drawer
- Drawer bases protected by foamed rubber mats
- Front centralized lock

75 kg



h	max
140 mm	30 kg
245 mm	40 kg

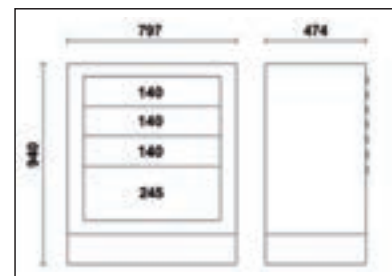

C55M4

1 055000212

C55M7

fixed module with seven drawers, for workshop equipment combination

- 7 drawers (588x367 mm) with ball bearing slides
- Aluminium opening system throughout length of drawer
- Drawer bases protected by foamed rubber mats
- Front centralized lock
- Can be fitted with foam trays

78 kg



h	max
70 mm	30 kg
245 mm	40 kg

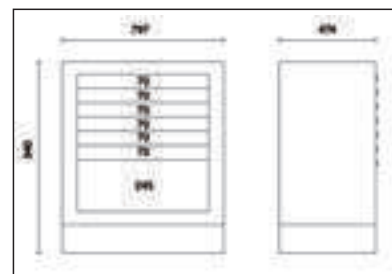

C55M7

1 055000203

C55M8

fixed module with 8 drawers for workshop equipment combination

- 8 drawers (588x367 mm) with ball bearing slides
- Aluminium opening system throughout length of drawer
- Drawer bases protected by foamed rubber mats
- Front centralized lock
- Can be fitted with foam trays

📦 78,9 kg



h	max
70 mm	30 kg
175 mm	40 kg

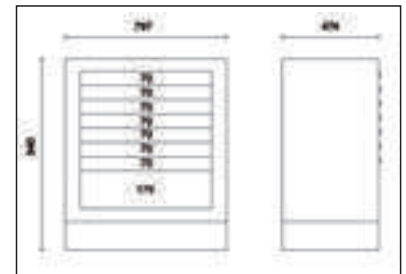

C55M8

1 055000207

C55CS

fixed sorted waste collection module for workshop equipment combination

- Pull-out waste compartment (588x465) with ball bearing slides
- 2 capacious pull-out interior containers for sorting waste

📦 62 kg

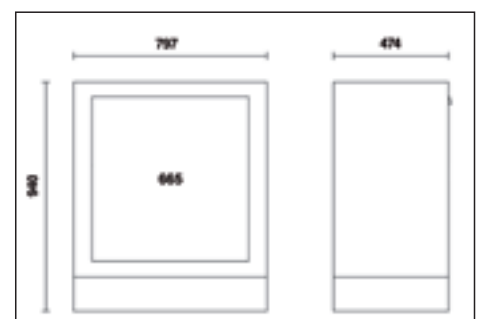

C55SC

1 055000208

C55MA

fixed two-door module, for workshop equipment combination

- Push Pull opening
- With lock• Interior shelf, vertically adjustable

📦 75 kg

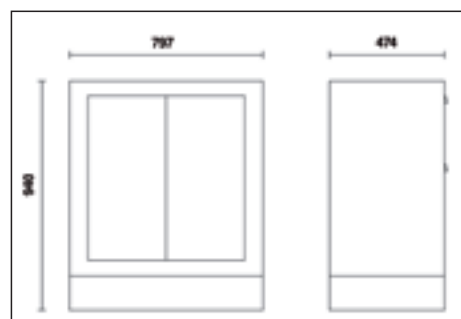

C55 MA

1 055000205

C55MDO

fixed oil distribution module
for workshop equipment combination

- 2 reels with 7m - 1/2" hose included
- Complete with 2 guns with digital litre counter and automatic drip catcher.
- max. flow rate: 35 l/min
- viscosity: 8÷5000 mPas

📦 94 kg

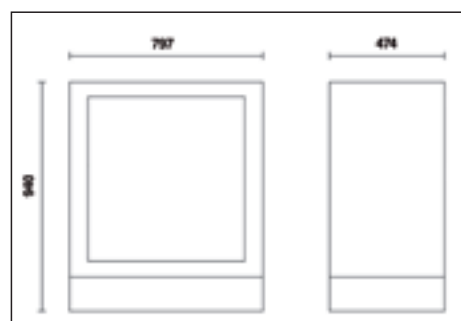

C55MDO

1 055000210

C55MS

fixed service module, for workshop equipment combination

- Built-in waste bin
- Perforated paper roll compartment
- Storage drawer, 305x270 mm

📦 75 kg

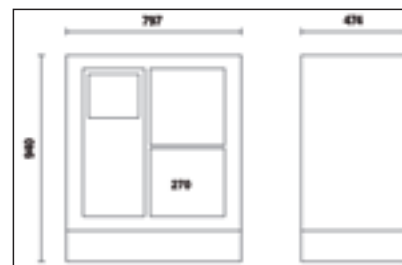

C55 MS



1 055000204

C55T3

trolley

- 3 tops covered in antislip ribbed rubber
- Ergonomic handle
- Two fixing options for central worktop
- Four castors Ø 100 mm:
2 fixed and 2 steering (one with brake).
- Static load capacity: 200 kg (distributed between 3 shelves)

📦 21 kg

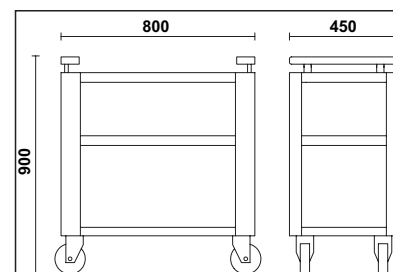

C55T3



1 055000219

C55P/MCD

double central intermediate uprights

10 kg

C55P/MCD

1 055000257



C55P/2MDX-SX

right/left wall uprights, pair

10 kg

C55P/2MDX-SX

1 055000253



C55PM

suspended cabinet for workshop equipment combination, 1 m long

- Dimensions: 1024x400x300 mm; fitted with gas springs, making it easier to open and close door

24 kg

C55PM

1 055000302

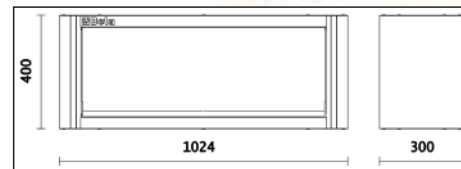

C55PFA-1,0

self-supporting perforated panel, 1 m long, for workshop equipment combination

Perforated steel tool panel (1024x25x1000 mm)

11 kg

C55PFA-1,0

1 055000316



C55/PF

perforated under-cabinet panel for workshop equipment combination, 1 m long

- Perforated tool panel (1024x600 mm)

6 kg

C55/PF

1 055000307



C55PT1,0X0,6

under-cabinet panel, 1 m long

Dimensions: 1024x25x620 mm

8 kg

C55PT1,0X0,6



1



055000314



C55PTE-1,0

under-cabinet panel, 1 m long

Dimensions: 1024x620 mm

Accommodates 2 power sockets (not included)

8 kg

C55PTE-1,0



1



055000319



C55/2PM

tool wall system with 2 suspended cabinets, for workshop equipment combination

- 2 suspended cabinets, 1024x400x300 mm, fitted with gas springs, making it easier to open and close doors.
- Wall panel, 2050x620 mm; can accommodate perforated tool panels C55/PF (to be ordered separately)
- Supplied with framework
- Matches 2-m-long workbench

80 kg

C55 2PM



1



055000301

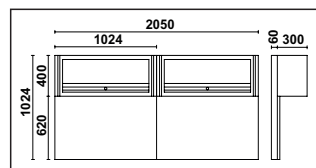
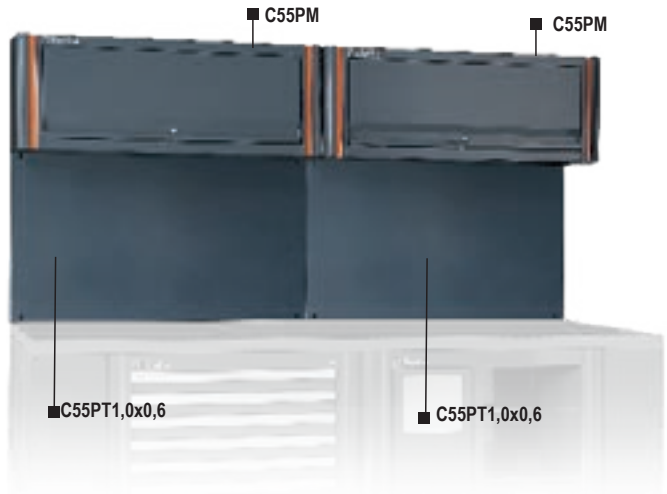

 **Beta**

C55PFA-0,8

self-supporting perforated panel, 0.8 m long, for workshop equipment combination

Perforated steel tool panel (800x25x1000 mm)

10 kg

C55PFA-0,8

1 055000315



C55PM/M0,8

suspended cupboard, 0.8 m long, for workshop equipment combination

Dimensions: 800x600 mm; fitted with gas springs making it easier to open and close door

19 kg

C55PM/M0,8

1 055000312

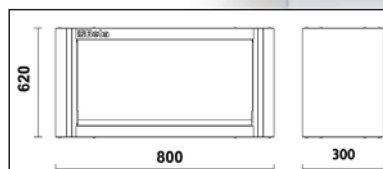

C55PTE-0,8

under-cabinet panel, 0.8 m long

Dimensions: 800x600 mm

Accommodates 1 power socket (not included)

6 kg

C55PTE-0,8

1 055000318



C55PT0,8X0,6

under-cabinet panel, 0.8 m long

Dimensions: 800x25x620 mm

7,8 kg

C55PT0,8X0,6

1 055000313



C55/1PF

perforated tool panel, for workshop equipment combination

• Perforated tool panel (800x600 mm)

5 kg

C55/1PF

1 055000309

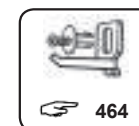

C55PS

tool wall system with shutter, for workshop equipment combination

- Aluminium shutter, vertically adjustable, with lock
- Removable perforated tool panel
- Supplied with framework
- 50-hook GPS kit included
- Matches 2-m-long workbench

88 kg

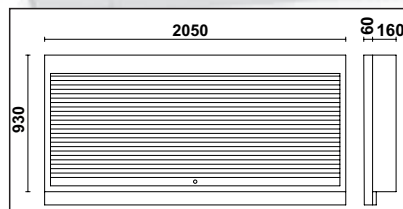

C55PS-O	1	055000250
C55PS-G	1	055000255

C55PSE

tool wall system with shutter
accommodating 2 power sockets

- Aluminium shutter, vertically adjustable, with lock
- Removable perforated tool panel
- Supplied with framework
- 50-hook GPS kit included
- Accommodates power sockets
- Matches 2-m-long workbench

88 kg

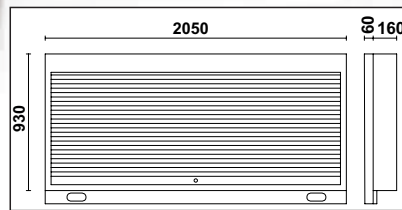
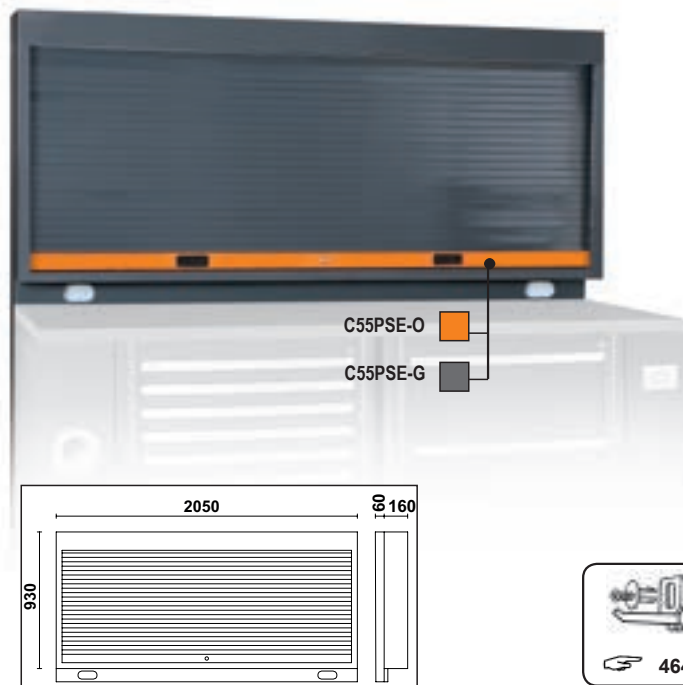

C55PSE-O	1	055000258
C55PSE-G	1	055000260

C55AE

profile, 2 m long, accommodating power sockets

Dimensions: 2050x25x90mm
Accommodates 2 power sockets

1,5 kg



C55AE	1	055000325
-------	---	-----------

C55AC

self-supporting complete corner

Worktop (700x700 mm) with legs
2 upper tool wall systems complete with 2 fixing shelves (665x150 mm)

66 kg



C55AC



1



055000360

C55KAI

corner worktop for workshop equipment combination

• Painted sheet metal worktop (700x700 mm) covered with a shockproof, non-scratch PVC coat, resistant to hydrocarbons

32 kg



C55KAI



1



055000365

C55KAS

upper corner with tool wall systems

• Perforated tool wall systems (700x1000 mm)
• 2 fixing shelves (665x150 mm)

24 kg



C55KAS



1



055000370

C55MP

steel corner wall shelves

Dimensions: 700x160x80 mm

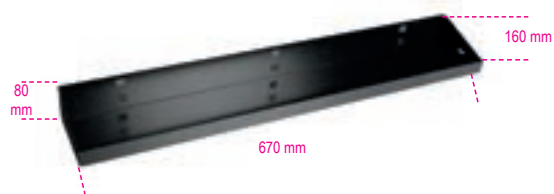

C55MP



1



055000374

Beta

C55B/1

workbench, 1 m long, for workshop equipment combination, with fixed module C55M4

Worktop (1024x700 mm) covered with a shockproof, non-scratch PVC coat, resistant to hydrocarbons

- Universal leg with vertically adjustable feet

1 fixed module:

- 7 drawers (588x367 mm) with ball bearing slides

- Aluminium opening system throughout length of drawer

- Drawer bases protected by foamed rubber mats

- Front centralized lock

127 kg

C55BO/1

C55BG/1



h	max
70 mm	30 kg
245 mm	40 kg

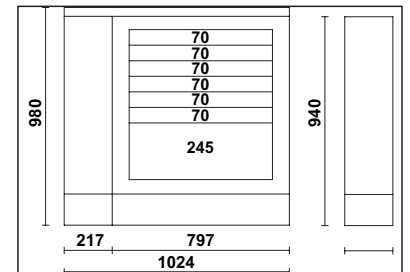

C55BO/1	1	055000090
C55BG/1	1	055000091

C55C

Cargo cabinets, RSC55 system

Developed on the basis of accurate research conducted with trained, professional users, they provide ideal solutions for working comfortably and rationally.

The opening system of the perforated panels of the two doors also allows the interior surface to be made the most of.

Main features:

- 1 drawer with ball bearing slides.

- Easy tool layout according to users' needs.

- Easy wall mounting by means of two slots located at the back of the cabinet.

- Safety lock for both drawers and doors.

- Empty thermoformed tray for 1/2" sockets and accessories.



37 kg



C55C	1	055000400
------	---	-----------

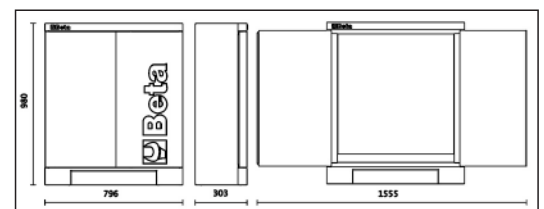

C55A1

sheet metal single-door tool cabinet, for workshop equipment combination

- 3 removable, vertically adjustable shelves
- With lock
- Usable interior dimensions: 177x42x42 cm

50 kg



C55A1

1 055000411

C55A1/R42

interior shelf for tool cabinet C55A1

2,4 kg

C55A1/R42

420x420 mm

1 055000461

Beta

C55A2

sheet metal two-door tool cabinet, for workshop equipment combination

- 3 removable, vertically adjustable shelves
- With lock
- Usable interior dimensions: 177x70x42 cm

📦 72 kg



C55A2

1 055000412

C55A2/R70

interior shelf for tool cabinet C55A2

📦 3,5 kg

C55A2/R70

700x420 mm

1 055000462

C55LMP/1

LED lamp for workshop equipment combination

- Length: 1 m
- Easy to fix under wall cabinet through a pair of magnets
- ON/OFF switch
- Built-in cable and transformer, 25 W
- 1300 lumens

📦 1,2 kg



C55LMP/1

1 055000320

C55LMP/2

2 LED lamps for workshop equipment combination C55

- length: 2 1-m-long lamps, connected to each other
- Easy to fix under cabinet through a pair of magnets
- ON/OFF switch
- Built-in cable and transformer, 25 W
- 1300 lumens

2 kg

C55LMP/2

1 055000322



C55STR

adhesive tape 25 m

allows to tailor the vertical tapes of garage furniture item C55

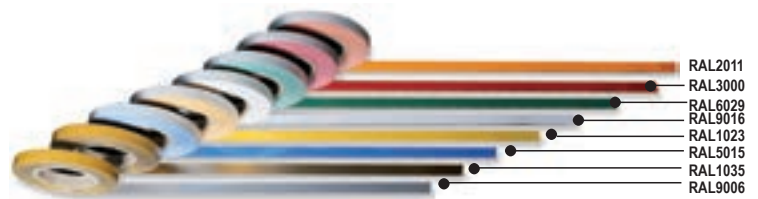

RAL2011
RAL3000
RAL6029
RAL9016
RAL1023
RAL5015
RAL1035
RAL9006

C55STR-O/2011



1 055000901

C55STR-R/3000



1 055000903

C55STR-V/6029



1 055000906

C55STR-W/9016



1 055000907

C55STR-Y/1023



1 055000905

C55STR-B/5015



1 055000904

C55STR-GO/1035



1 055000909

C55STR-S/9006



1 055000902



9562P2

multilogo mat, 200x80 cm

- particularly suitable for use with workshop equipment item C55 or under motorcycles

9562P2

1 095620400



9562P25

multilogo mat roll, 25 m x 80 cm

Allows mat length to be customized as needed

9562P25

1 095620425



C45



C45/X

workshop equipment combination C45

Combination comprising:

- Worktop made of coated MDF stainless steel (C45PX/3-2,0MT)
- Fixed module with 7 drawers (C45M7)
- Fixed service module (C45MS)
- Mobile roller cab with 7 drawers (C45C7)
- Two-door tool cabinet (C45AS2)
- 3 perforated tool panels (C45PF)
- 3 wall-mounted cupboards (C45PM)
- 3 wall brackets, wide type (C45SL)
- 1 wall bracket, narrow type (C45SS)

305 kg

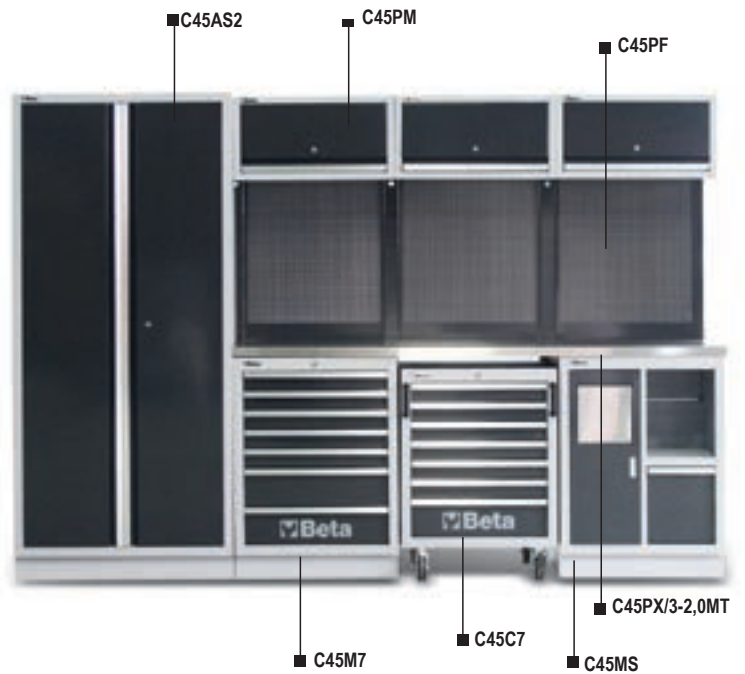

C45/X

1 045000010



C45/W

workshop equipment combination C45

Combination comprising:

- Multi-ply wood worktop (C45PW/3-2,0MT)
- Fixed module with 7 drawers (C45M7)
- Fixed service module (C45MS)
- Mobile roller cab with 7 drawers (C45C7)
- Two-door tool cabinet (C45AS2)
- 3 perforated tool panels (C45PF)
- 3 tool wall systems with 1 wall-mounted cabinet (C45PM)
- 3 wall brackets, wide type (C45SL)
- 1 wall bracket, narrow type (C45SS)

303 kg

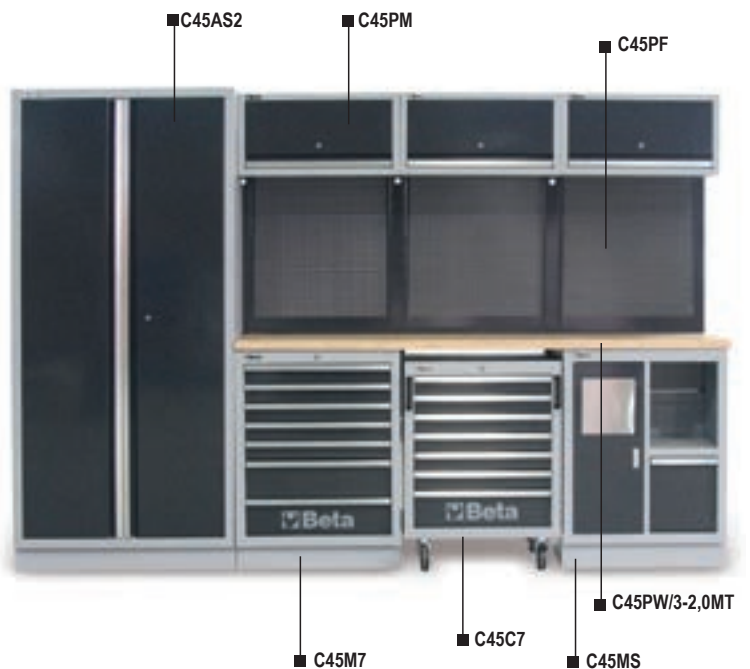

C45/W

1 045000020



C45/AX

workshop equipment combination C45

Combination comprising:

- Worktop made of coated MDF stainless steel (C45PX/3-2.0MT)
- Fixed module with 7 drawers (C45M7)
- Fixed service module (C45MS)
- Fixed two-door module (C45MA)
- 3 wall-mounted cabinets (C45PM)
- 3 perforated tool panels (C45PF)
- 2 wall brackets, wide type (C45SL)
- 2 wall brackets, narrow type (C45SS)

206 kg

C45/AX

1 045000030

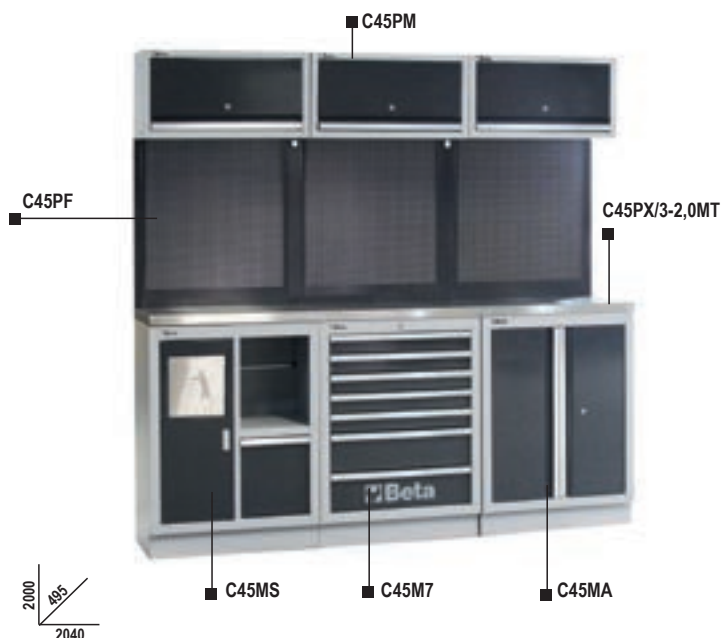

C45/AW

workbenches for workshop equipment combination C45

Combination comprising:

- Multi-ply wood worktop (C45PW/3-2.0MT)
- Fixed two-door module (C45MA)
- Fixed module with 7 drawers (C45M7)
- Fixed service module (C45MS)
- 3 wall-mounted cabinets (C45PM)
- 3 perforated tool panels (C45PF)
- 2 wall brackets, narrow type (C45SS)
- 2 wall brackets, wide type (C45SL)

204 kg

C45/AW

1 045000040

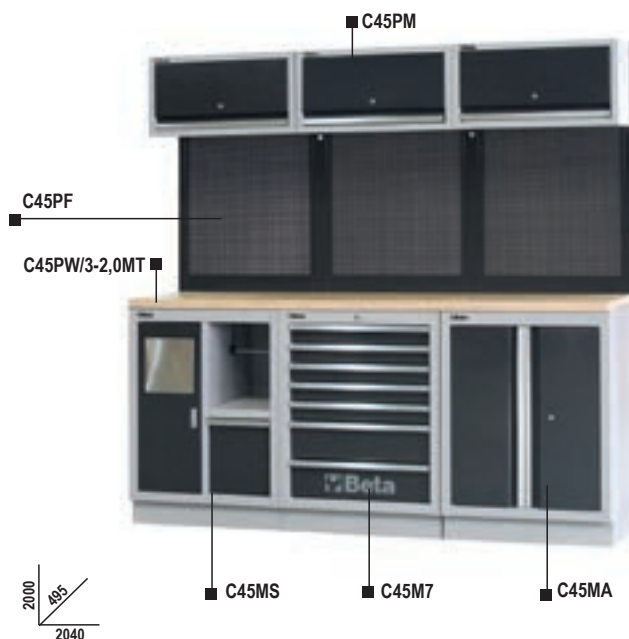

C45/BX

workshop equipment combination C45

Combination comprising:

- Worktop made of coated MDF stainless steel (C45PX/2-1.3MT)
- Fixed module with 5 drawers (C45M5)
- Fixed two-door module (C45MA)
- Single-door tool cabinet (C45AS1)
- 2 wall-mounted cabinets (C45PM)
- 2 perforated tool panels (C45PF)
- 2 wall brackets, wide type (C45SL)
- 1 wall bracket, narrow type (C45SS)

191 kg

C45/BX

1 045000043



C45/BW

workshop equipment combination C45

Combination comprising:

- Multi-ply wood worktop (C45PW/2-1.3MT)
- Fixed module with 5 drawers (C45M5)
- Fixed two-door module (C45MA)
- Single-door cabinet (C45AS1)
- 2 wall-mounted cabinets (C45PM)
- 2 perforated tool panels (C45PF)
- 2 wall brackets, wide type (C45SL)
- 1 wall bracket, narrow type (C45SS)

190 kg

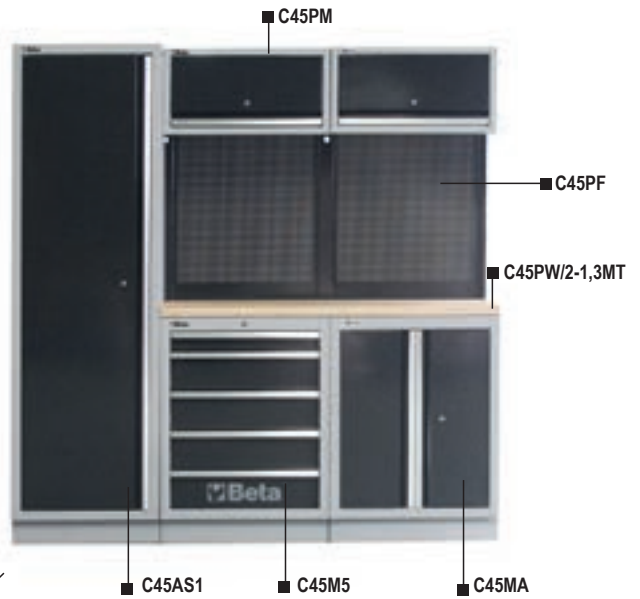

C45/BW

1 045000053



C45/CX

workshop equipment combination C45

Combination comprising:

- Worktop made of coated MDF stainless steel (C45PX/2-1.3MT)
- Fixed module with 7 drawers (C45M7)
- Fixed service module (C45MS)
- Single-door tool cabinet (C45AS1)
- 2 wall-mounted cabinets (C45PM)
- 2 perforated tool panels (C45PF)
- 2 wall brackets, wide type (C45SL)
- 1 wall bracket, narrow type (C45SS)

199 kg

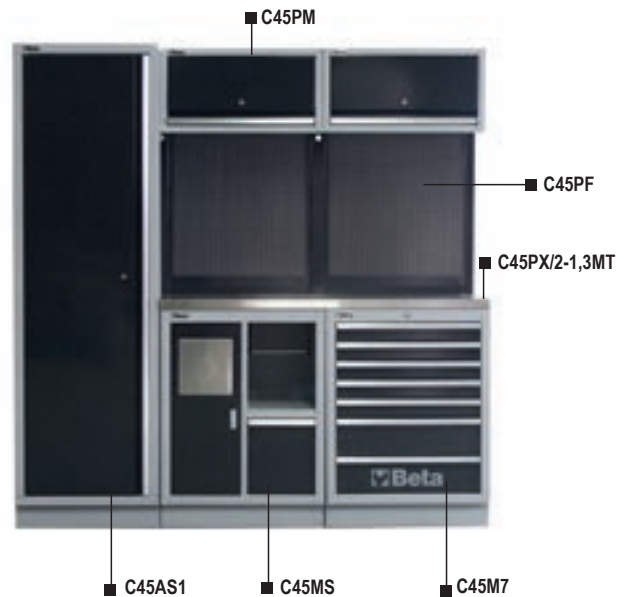

C45/CX

1 045000063



C45/CW

workshop equipment combination C45

Combination comprising:

- Multi-ply wood worktop (C45PW/2-1.3MT)
- Fixed module with 7 drawers (C45M7)
- Fixed service module (C45MS)
- Single-door tool cabinet (C45AS1)
- 2 wall-mounted cabinets (C45PM)
- 2 perforated tool panels (C45PF)
- 2 wall brackets, wide type (C45SL)
- 1 wall bracket, narrow type (C45SS)

198 kg

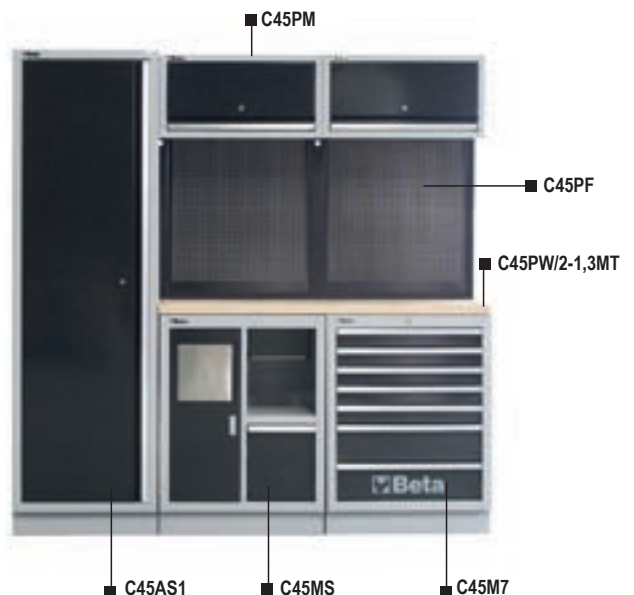

C45/CW

1 045000073



C45/BPX-1,3

workbenches for workshop equipment combination C45/BPX-1,3

Combination comprising:

- Worktop made of coated MDF stainless steel (C45PX/2-1.3MT)
- Fixed module with 7 drawers (C45M7)
- Fixed module with 5 drawers (C45M5)
- 2 perforated tool panels (C45PF)
- 1 wall bracket, wide type (C45SL)
- 2 wall brackets, narrow type (C45SS)

140 kg

C45/BPX-1,3

1 045000083



C45/BPW-1,3

workbenches for workshop equipment combination C45/BPW-1,3

Combination comprising:

- Multi-ply wood worktop (C45PW/2-1.3MT)
- Fixed module with 7 drawers (C45M7)
- Fixed module with 5 drawers (C45M5)
- 2 perforated tool panels (C45PF)
- 1 wall bracket, wide type (C45SL)
- 2 wall brackets, narrow type (C45SS)

139 kg

C45/BPW-1,3

1 045000093



C45/BPX-2,0

workbenches for workshop equipment combination C45/BPX-2,0

Combination comprising:

- Worktop made of coated MDF stainless steel (C45PX/3-2.0MT)
- Fixed module with 7 drawers (C45M7)
- Fixed module with 5 drawers (C45M5)
- 3 perforated tool panels (C45PF)
- 2 wall brackets, wide type (C45SL)
- 2 wall brackets, narrow type (C45SS)

158 kg

C45/BPX-2,0

1 045000090

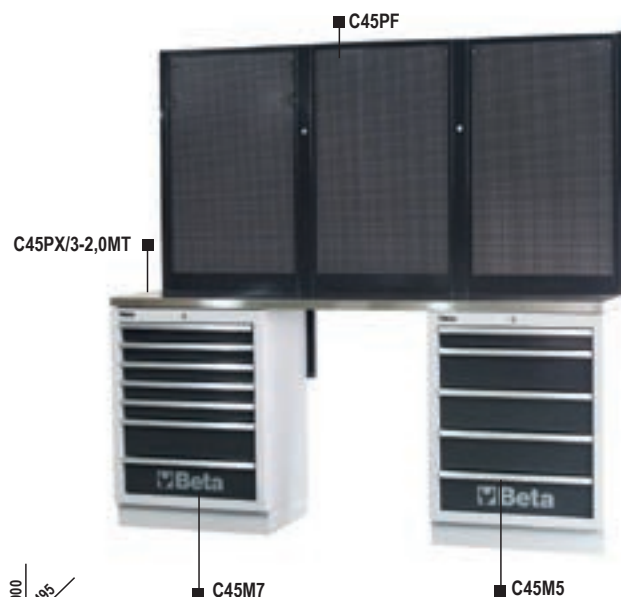

C45/BPW-2,0

workbenches for workshop equipment combination C45/BPW-2,0

Combination comprising:

- Multi-ply wood worktop (C45PW/3-2.0MT)
- Fixed module with 7 drawers (C45M7)
- Fixed module with 5 drawers (C45M5)
- 3 perforated tool panels (C45PF)
- 2 wall brackets, wide type (C45SL)
- 2 wall brackets, narrow type (C45SS)

156 kg

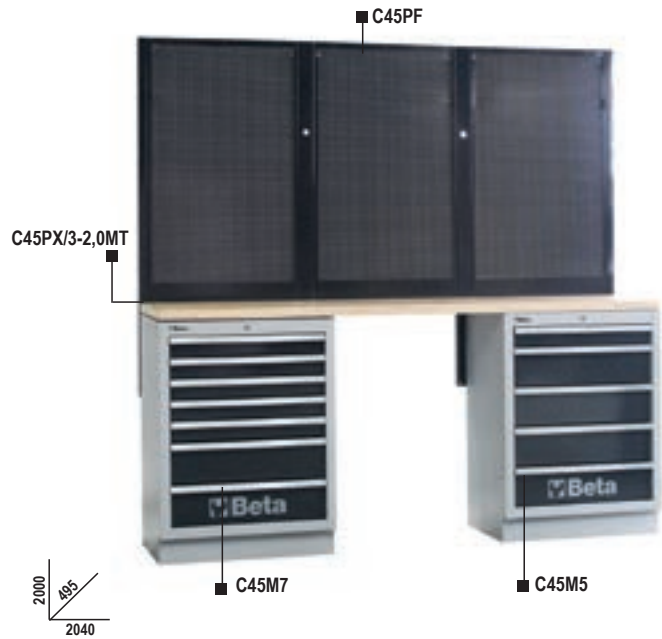

C45/BPW-2,0

1 045000100

C45PX/2-1,3MT

1.3-m-long worktop made of coated MDF stainless steel, for workshop equipment combination C45

Worktop made of coated MDF stainless steel, 1361x463 mm; workbench thickness: 38 mm

21 kg



C45PX/2-1,3MT

1 045000103

C45PW/2-1,3MT

1.3-m-long wood worktop for workshop equipment combination C45

Wood worktop, 1361x463 mm; workbench thickness: 38 mm

20 kg



C45PW/2-1,3MT

1 045000113

C45PX/3-2,0MT

2-m-long worktop made of stainless steel coated MDF for workshop equipment combination C45

Worktop made of stainless steel coated MDF, 2041x463 mm; workbench thickness: 38 mm

31,8 kg



C45PX/3-2,0MT

1 045000110

C45PW/3-2,0MT

2-m-long wood worktop for workshop equipment combination C45

Wood worktop, 2041x463 mm; workbench thickness: 38 mm

30 kg



C45PW/3-2,0MT

1 045000120

C45C7

mobile roller cab with 7 drawers, for workshop equipment combination

- 7 drawers (532x406 mm) with ball bearing slides
- 4 steering castors Ø 100 mm (1 with brake)
- Drawer bases protected by foamed rubber mats

50 kg

h	max
65 mm	25 kg
145 mm	30 kg

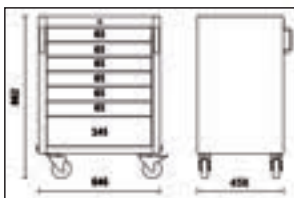
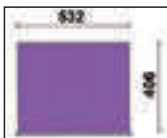

C45C7

1 045000207

C45M5

fixed module with 5 drawers, for workshop equipment combination

- 5 drawers (566x406 mm) with ball bearing slides
- Drawer bases protected by foamed rubber mats
- Front centralized lock
- Can be fitted with foam trays

49,3 kg

h	max
65 mm	25 kg
145 mm	30 kg

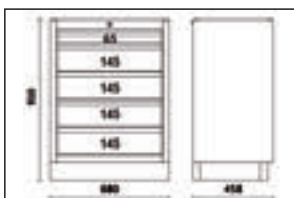
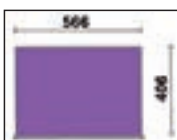

C45M5

1 045000215

C45M7

fixed module with 7 drawers, for workshop equipment combination

- 7 drawers (566x406 mm) with ball bearing slides
- Drawer bases protected by foamed rubber mats
- Front centralized lock
- Can be fitted with foam trays

54,3 kg

h	max
65 mm	25 kg
145 mm	30 kg

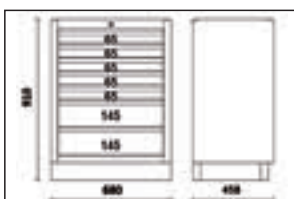
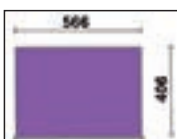

C45M7

1 045000217

C45MS

fixed service module for workshop equipment combination C45

- Built-in waste bin
- Perforated paper roll compartment

37 kg

C45MS

1 045000219

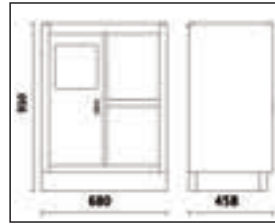

C45MA

fixed two-door module for workshop equipment combination

- With lock
- Interior shelf, vertically adjustable
- Interior dimensions: 670x420 mm
680x458x910 mm

29,4 kg

C45MA

1 045000212

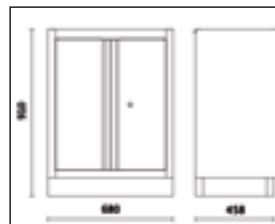

C45SS

side wall brackets, narrow type, for item C45

1420x32.5x30 mm

1,5 kg

C45SS

1 045000332



C45SL

side wall brackets, wide type, for item C45

1420x65x30 mm

2 kg

C45SL

1 045000365



C45PF

perforated tool panel for workshop equipment combination

1052x614.5 mm

5,3 kg



C45PF



1



045000311



C45CORNER/X

self-supporting complete corner

- Suspended corner cabinet with gas springs, making it easier to open and close door
- Two perforated tool panels (1052x800 mm)
- Stainless steel corner worktop (865 x 865 mm)
- Lower corner module with large storage compartment

94 kg



C45CORNER/X



1



045000400

C45CORNER/W

self-supporting complete corner

- Suspended corner cabinet with gas springs, making it easier to open and close door
- Two perforated tool panels (1052x800 mm)
- Wood corner worktop (865 x 865 mm)
- Lower corner module with large storage compartment

93 kg



C45CORNER/W



1



045000410

C45PM

wall-mounted suspended cabinet for workshop equipment combination

680x281x350 mm

fitted with gas springs, making it easier to open and close door

10 kg



C45PM



1 045000301

C45AS1

sheet metal single-door tool cabinet for workshop equipment combination, with one wide bracket

- 4 removable, vertically adjustable shelves
- With lock
- Interior dimensions: 590x430 mm
- 600x458x2000 mm

57,5 kg

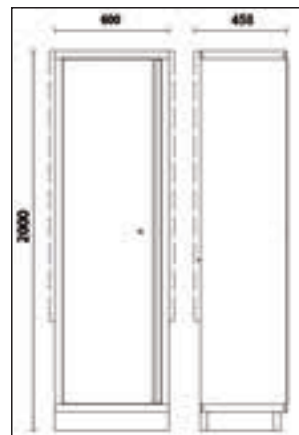

C45AS1



1 045000450

C45AS2

sheet metal two-door tool cabinet for workshop equipment combination, with one wide bracket

- 4 removable, vertically adjustable shelves
- With lock
- Interior dimensions: 910x430 mm
- 915x458x2000 mm

80 kg

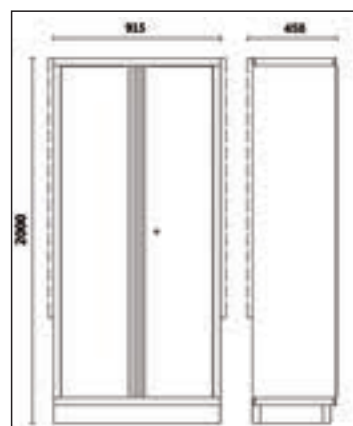

C45AS2



1 045000480

C45LMP

LED lamp for workshop equipment combination C45

- Length: 630 mm
- Easy to fix under wall cabinet through adhesives
- ON/OFF switch
- 570 lumens



307 g

C45LMP 1 045000320

PM/5C

5-tray tool holder, made of plastic, with support

- Interior dimensions of tray: 95x120 mm
- Can be used with tool wall systems C45 and RSC55

1,8 kg



PM/5C 1 088880450



PM/6C

6-tray tool holder, made of plastic, with support

- Interior dimensions of tray: 80x60 mm
- Can be used with tool wall systems C45 and RSC55

970 g



PM/6C 1 088880440



CP

wall-mounted bottle holder rack, made of steel

- Can be used with wall-mounted tool panels



CP 1 088880470



Industrial maintenance



19.5 kg

Quantity/Description

6	pin punches Ø 2 - 3 - 4 - 5 - 6 - 8 mm	Beta N.	31
1	centre punch Ø 3 mm		32
1	flat chisels, ribbed type 200 mm		35
26	combination wrenches 6÷32 mm	42/S26	
12	double open end wrenches 6x7 - 8x9 - 10x11 - 12x13 - 14x15 - 16x17 - 18x19 - 20x22 - 21x23 - 24x26 - 25x28 - 30x32 mm	55/S12	
9	offset hexagon key wrenches ○ 1,5 - 2 - 2,5 - 3 - 4 - 5 - 6 - 8 - 10 mm	96N/SC9	
1	adjustable wrench 300 mm		111
13	1/2" square drive hexagon sockets with rail ○ 10÷22 mm	920A/SB13	
1	1/2" drive extension bar 125 mm		920/21
1	1/2" drive extension bar 255 mm		920/22
1	1/2" drive universal joint		920/25
1	1/2" drive sliding T-handle		920/42
1	1/2" drive reversible ratchet		920/55
1	Slip joint pliers boxed joints 250 mm		1048
1	self - locking pliers 240 mm		1052
1	heavy duty diagonal cutting nippers 160 mm		1084BM
1	compound leverage shears, straight blades 250 mm		1122
1	electrician's scissors, straight blades		1128BMX

Quantity/Description

1	half-round needle nose pliers 180 mm	Beta N.	1150BM
1	extra long needle knurled nose pliers, bi-material handles 160 mm		1166BM
8	screwdrivers for cross head Phillips® screws 2,5x50 - 3x75 - 3,5x100 - 4x125 - 5,5x125 - 6,5x150 - 8x200 - 10x200 mm		1260
4	screwdrivers for cross head Phillips® screws PH0x60 - PH1x80 - PH2x100 - PH3x150 mm		1262
1	engineer's hammer 500 g		1370
1	dead blow hammer Ø 40 mm		1392
1	engineer's scriber		1688A
1	measuring tape 5 m		1692
1	metric feeler gauge		1708/20
5	Set of 5 second-cut files, with handles 200 mm		1719BMA/S5
1	hacksaw frame, aluminium handle		1726BM
1	metal oil can 300 cc		1751
1	snap - off blade utility knife		1771BM
1	magnetic, articulated lamp with high-brightness LEDs		1837N

5902VI

059020060

Assortment recommended in combination with C22S - C23S - C23ST - C25 - C27S

5904VI/1T

Assortment of 98 tools

Industrial maintenance



T80

T15

T16



T153

T131

T145

T236



T234

T33

T208

T68

14.5 kg

Quantity/Description

19	1/2" square drive hexagon sockets \odot 10-24 - 26 - 27 - 30 - 32 mm	920A	T80
5	1/2" drive, socket drivers for hexagon screws \odot 5 - 6 - 8 - 10 - 12 mm	920ME	T80
1	1/2" drive extension bar 125 mm	920/21	T80
1	1/2" drive extension bar 255 mm	920/22	T80
1	1/2" drive universal joint	920/25	T80
1	1/2" drive sliding T-handle	920/42	T80
1	1/2" drive reversible ratchet \oplus	920/55	T80
16	combination wrenches 6-21 mm	42	T15
5	combination wrenches 22-24-27-30-32 mm	42	T16
1	Slip joint pliers boxed joints 250 mm	1048	T153
1	self - locking pliers 240 mm	1052	T153
1	heavy duty diagonal cutting nippers \nless 160 mm	1084BM	T131
1	half-round needle nose pliers \equiv 180 mm	1150BM	T131
1	extra long needle knurled nose pliers, bi-material handles \bullet 160 mm	1166BM	T131
1	circlip pliers straight, internal \odot 180 mm	1032	T145
1	circlip pliers bent, internal \odot 170 mm	1034	T145

Beta N. TR

Quantity/Description

1	circlip pliers straight, external \bullet 175 mm	1036	T145
1	circlip pliers bent, external \bullet 175 mm	1038	T145
5	second cut files 200 mm	1719BMA8/S5	T236
2	flat chisels, ribbed type 100 - 200 mm	35	T234
1	engineer's hammer 300 g	1370	T234
1	soft face hammer \varnothing 35 mm	1390	T234
8	double open end wrenches 6x7 - 8x9 - 10x11 - 12x13 - 14x15 - 16x17 - 18x19 - 20x22 mm	55	T33
9	offset hexagon key wrenches \odot 1,5 - 2 - 2,5 - 3 - 4 - 5 - 6 - 8 - 10 mm	96/SC9	T33
4	screwdrivers for cross head Phillips® screws \bullet 3x75 - 4x100 - 5,5x150 - 6,5x150 mm	1260	T208
3	screwdrivers for cross head Phillips® screws \oplus PH0x60 - PH1x80 - PH2x100 mm	1262	T208
6	T-handle wrenches with hexagon male ends \odot 2,5 - 3 - 4 - 5 - 6 - 8 mm	951	T68

Beta N. TR

5904 VI/1T

059040161

Assortment recommended in combination with C24S - C24SA - C24SA-XL - C37 - C39 with 6 - 7 - 8 drawers
C23ST - C39T - C24SL - C24SL/CAB - C59 - C55 - C28 - C39MD - C39SM

Industrial maintenance



T15 T16 T31



T40 T83 T91



T167 T168



T153 T132 T145 T68



T236 T234 T281 T289

22 kg

Quantity/Description	Beta N.	TR	Quantity/Description	Beta N.	TR
16 combination wrenches 6÷21 mm	42	T15	2 screwdrivers for cross head Phillips® screws, extra - short series PH1x30 - PH2x30 mm	1262N	T168
5 combination wrenches 22 - 24 - 27 - 30 - 32 mm	42	T16	1 Slip joint pliers boxed joints 250 mm	1048	T153
5 pin punches Ø 2 - 3 - 4 - 5 - 6 mm	31	T31	1 self - locking pliers 240 mm	1052	T153
1 centre punch Ø 4 mm	32	T31	1 heavy duty diagonal cutting nippers < 160 mm	1084	T132
12 double open end wrenches 6x7 - 8x9 - 10x11 - 12x13 - 14x15 - 16x17 - 18x19 - 20x22 - 21x23 - 24x26 - 27x29 - 30x32 mm	55	T31	1 screwdrivers for slotted head screws 160 mm	1166	T132
9 offset hexagon key wrenches 1,5 - 2 - 2,5 - 3 - 4 - 5 - 6 - 8 - 10 mm	96N/SC9	T31	1 half-round needle nose pliers 180 mm	1150	T132
7 double ended offset ring wrenches 6÷29 mm	90	T40	1 circlip pliers straight, internal 180 mm	1032	T145
19 1/2" square drive hexagon sockets 10÷24 - 26 - 27 - 30 - 32 mm	920A	T83	1 circlip pliers bent, internal 170 mm	1034	T145
1 1/2" drive extension bar 125 mm	920/21	T83	1 circlip pliers straight, external 175 mm	1036	T145
1 1/2" drive extension bar 255 mm	920/22	T83	1 circlip pliers bent, external 175 mm	1038	T145
1 1/2" drive universal joint	920/25	T83	6 T-handle wrenches with hexagon male ends 2,5 - 3 - 4 - 5 - 6 - 8 mm	951	T68
1 1/2" drive sliding T-handle	920/42	T83	5 second cut files 200 mm	1719BMA8/S5	T236
1 1/2" drive reversible ratchet	920/55	T83	2 flat chisels, ribbed type 100 - 200 mm	35	T234
13 1/4" hexagon sockets 4÷14 mm	900	T91	1 engineer's hammer 300 g	1370	T234
6 1/4" socket drivers for hexagon screws 2,5÷8 mm	900ME	T91	1 soft face hammer Ø 35 mm	1390	T234
1 1/4" drive extension bar 50 mm	900/20	T91	1 riveting pliers	1741B	T281
1 1/4" drive extension bar 150 mm	900/21	T91	100 aluminium rivets 2,9x6 mm	1741RV...K	T281
1 1/4" drive universal joint	900/25	T91	100 aluminium rivets 3,2x8 mm	1741RV...K	T281
1 1/4" drive spinner handle	900BG/30	T91	100 aluminium rivets 3,8x10 mm	1741RV...K	T281
1 1/4" drive swivel T-handle	900/42	T91	100 aluminium rivets 4x12 mm	1741RV...K	T281
1 1/4" reversible ratchet	900/55	T91	100 aluminium rivets 4,8x12 mm	1741RV...K	T281
9 screwdrivers for cross head Phillips® screws 3x75 - 3x100 - 4x100 - 4x150 - 5,5x100 - 5,5x150 - 6,5x150 - 8x150 - 10x200 mm	1260	T167	1 measuring tape	1692	T289
2 screwdrivers for slotted head screws, extra-short series 4x30 - 6,5x30 mm	1260N	T167	1 mini hacksaw frame	1725CR	T289
7 screwdrivers for cross head Phillips® screws PH0x60 - PH0x100 - PH1x80 - PH1x120 - PH2x100 - PH2x150 - PH3x150 mm	1262	T168	1 plastic oil bottle	1755	T289
			1 snap - off blade utility knife	1771	T289

5904VI/3T

assortment of 142 tools in thermoformed tray

Industrial maintenance



26.5 kg

Quantity/Description	Beta N.	TR	Quantity/Description	Beta N.	TR
16 combination wrenches 6÷21 mm	42	T15	1 heavy duty diagonal cutting nippers \leq 160 mm	1084BM	T131
5 combination wrenches 22 - 24 - 27 - 30 - 32 mm	42	T16	1 Slip joint pliers boxed joints 250 mm	1048	T153
5 pin punches \varnothing 2 - 3 - 4 - 5 - 6 mm	31	T31	1 self - locking pliers 240 mm	1052	T153
1 centre punch \varnothing 4 mm	32	T31	1 circlip pliers straight, internal \varnothing 180 mm	1032	T145
12 double open end wrenches 6x7 - 8x9 - 10x11 - 12x13 - 14x15 - 16x17 - 18x19 - 20x22 - 21x23 - 24x26 - 27x29 - 30x32 mm	55	T31	1 circlip pliers bent, internal \varnothing 170 mm	1034	T145
9 offset hexagon key wrenches \varnothing 1,5 - 2 - 2,5 - 3 - 4 - 5 - 6 - 8 - 10 mm	96N/SC9	T31	1 circlip pliers straight, external \bullet 175 mm	1036	T145
9 screwdrivers for cross head Phillips® screws \bullet 3x75 - 3,5x100 - 4x100 - 4x150 - 5,5x100 - 5,5x150 - 6,5x150 - 8x150 - 10x200 mm	1260	T167	1 circlip pliers bent, external \bullet 175 mm	1038	T145
2 screwdrivers for slotted head screws, extra-short series \bullet 4x30 - 6,5x30 mm	1260N	T167	1 circlip pliers straight, internal \varnothing 140 mm	1032	T146
6 screwdrivers for cross head Phillips® screws \oplus PH0x60 PH0x100 - PH1x80 - PH1x120 - PH2x100 - PH2x150 mm	1262	T202	1 circlip pliers bent, internal \varnothing 225 mm	1034	T146
7 drivers for Torx® head screws \odot T6-T7-T8-T9-T10-T15-T20	1267TX	T205	1 circlip pliers straight, external \bullet 140 mm	1036	T146
5 1/2" drive, socket drivers for hexagon screws \odot 5 - 6 - 8 - 10 - 12 mm	920ME	T80	1 circlip pliers bent, external \bullet 225 mm	1038	T146
1 1/2" drive extension bar 125 mm	920/21	T80	1 engineer's hammer 400 g	1370	T231
1 1/2" drive extension bar 255 mm	920/22	T80	1 soft face hammer \varnothing 35 mm	1390	T231
1 1/2" drive universal joint	920/25	T80	1 second cut files 200 mm	1719BMA8/T	T231
1 1/2" drive sliding T-handle	920/42	T80	1 second cut files 200 mm	1719BMA8/P	T231
1 1/2" drive reversible ratchet \oplus	920/55	T80	1 second cut files 200 mm	1719BMA8/M	T231
19 1/2" square drive hexagon sockets \odot 10+24 - 26 - 27 - 30 - 32 mm	920A	T80	1 digital vernier	1651DGT	T297
8 double ended bi-hex tubular socket wrenches 6x7 - 8x9 10x11 - 12x13 - 14x15 - 16x17 - 18x19 - 20x22 mm	930	T73	1 flexible graduated rule 300 mm	1682	T297
1 tommy bars for tubular wrenches	940/1	T73	1 measuring tape 5 m	1691BM	T297
1 tommy bars for tubular wrenches	940/2	T73	1 riveting pliers 250 mm	1741B	T281
6 T-handle wrenches with hexagon male ends \odot 2,5 - 3 - 4 - 5 - 6 - 8 mm	951	T68	100 aluminium rivets 2,9x6 mm	1741RV...K	T281
1 half-round needle nose pliers \equiv 180 mm	1150BM	T131	100 aluminium rivets 3,2x8 mm	1741RV...K	T281
1 extra long needle knurled nose pliers, bi-material handles \bullet 160 mm	1166BM	T131	100 aluminium rivets 3,8x10 mm	1741RV...K	T281
			100 aluminium rivets 4x12 mm	1741RV...K	T281
			100 aluminium rivets 4,8x12 mm	1741RV...K	T281
			1 tin snips 250 mm	1112	T285
			1 electrician's scissors, straight blades	1128BM	T285
			1 hacksaw frame, aluminium handle	1726	T285
			(5) blades for hacksaw	1728BM	T285
			1 plastic oil can 200 cc	1753	T285
			empty thermoformed tray	VP6	VP6

5904VI/3T

059040168

Assortment recommended in combination with C24S with 8 drawers - C24S/A with 8 drawers - C37 with 8 drawers - C39 with 8 drawers - C24SA-XL with 8-9 drawers - C28 - C39MO - C39SM - C55 - C59B

Industrial maintenance

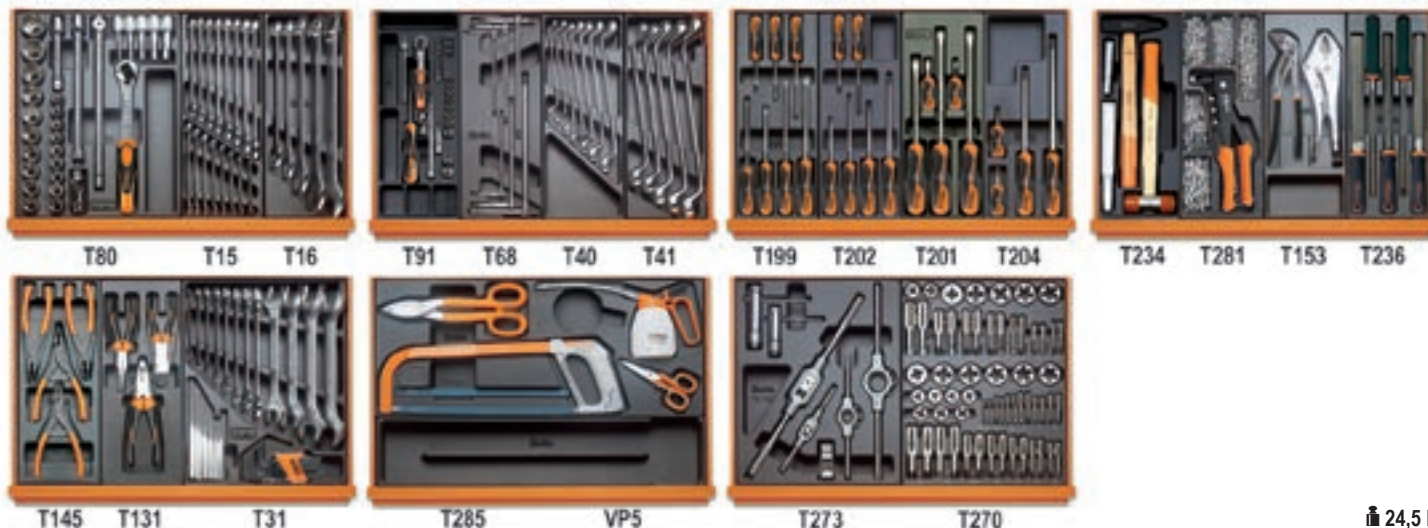

24,5 kg

Quantity/Description

Beta N. TR

Quantity/Description

Beta N. TR

5	1/2" drive, socket drivers for hexagon screws \varnothing 5 - 6 - 8 - 10 - 12 mm	920ME	T80
1	1/2" drive extension bar 125 mm	920/21	T80
1	1/2" drive extension bar 255 mm	920/22	T80
1	1/2" drive universal joint	920/25	T80
1	1/2" drive sliding T-handle	920/42	T80
1	1/2" drive reversible ratchet \otimes	920/55	T80
19	1/2" square drive hexagon sockets \varnothing 10+24 - 26 - 27 - 30 - 32 mm	920A	T80
16	combination wrenches 6+21 mm	42	T15
5	combination wrenches 22 - 24 - 27 - 30 - 32 mm	42	T16
13	1/4" hexagon sockets \varnothing 4+14 mm	900	T91
6	1/4" socket drivers for hexagon screws \varnothing 2,5 - 3 - 4 - 5 - 6 - 8 mm	900ME	T91
1	1/4" drive extension bar 50 mm	900/20	T91
1	1/4" drive extension bar 150 mm	900/21	T91
1	1/4" drive spinner handle	900BG/30	T91
1	1/4" drive universal joint	900/25	T91
1	1/4" drive swivel T-handle	900/42	T91
1	1/4" reversible ratchet \otimes	900/55	T91
6	T-handle wrenches with hexagon male ends \varnothing 2,5 - 3 - 4 - 5 - 6 - 8 mm	951	T68
7	double ended offset ring wrenches 6x7-8x9-10x11-12x13-14x15-16x17-18x19 mm	90	T40
5	double ended offset ring wrenches 20x22 - 21x23 - 24x26 - 25x28 - 27x29 mm	90	T41
7	screwdrivers for cross head Phillips® screws \bullet 2,5x50 - 3x75 - 3,5x100 - 4x125 - 5,5x100 - 5,5x150 - 6,5x150 mm	1260	T199
6	screwdrivers for cross head Phillips® screws \oplus PH0x60 - PH0x100 - PH1x80 - PH1x120 - PH2x100 - PH2x150 mm	1262	T202
3	screwdrivers for cross head Phillips® screws \bullet 8x200 - 10x150 - 10x200 mm	1260	T201
2	screwdrivers for slotted head screws, extra-short series \bullet 4x30 - 6,5x30 mm	1260N	T201
2	screwdrivers for cross head Phillips® screws \oplus PH3x150 - PH4x200 mm	1262	T204
2	screwdrivers for cross head Phillips® screws, extra - short series \oplus PH1x30 - PH2x30 mm	1262N	T204
2	flat chisels, ribbed type 100 - 200 mm	35	T234
1	engineer's hammer 300 g	1370	T234
1	soft face hammer \varnothing 35 mm	1390	T234
1	riveting pliers 250 mm	1741B	T281
100	aluminium rivets 2,9x6 mm	1741RV...K	T281
100	aluminium rivets 3,2x8 mm	1741RV...K	T281
100	aluminium rivets 3,8x10 mm	1741RV...K	T281

100	aluminium rivets 4x12 mm	1741RV...K	T281
100	aluminium rivets 4,8x12 mm	1741RV...K	T281
1	Slip joint pliers boxed joints 250 mm	1048	T153
1	self - locking pliers 240 mm	1052	T153
5	second cut files 200 mm	1719BMA8/S	T236
1	circlip pliers straight, internal \odot 180 mm	1032	T145
1	circlip pliers bent, internal \odot 170 mm	1034	T145
1	circlip pliers straight, external \bullet 175 mm	1036	T145
1	circlip pliers bent, external \bullet 175 mm	1038	T145
1	half-round needle nose pliers \equiv 180 mm	1150BM	T131
1	extra long needle knurled nose pliers, bi-material handles \bullet 160 mm	1166BM	T131
1	heavy duty diagonal cutting nippers \llcorner 160 mm	1084BM	T131
5	pin punches \varnothing 2 - 3 - 4 - 5 - 6 mm	31	T31
1	centre punch \varnothing 4 mm	32	T31
12	double open end wrenches 6x7 - 8x9 - 10x11 - 12x13 - 14x15 - 16x17	55	T31
9	offset hexagon key wrenches \varnothing 1,5 - 2 - 2,5 - 3 - 4 - 5 - 6 - 8 - 10 mm	96N/SC9	T31
1	tin snips 250 mm	1112	T285
1	electrician's scissors, straight blades	1128BM	T285
1	hacksaw frame, aluminium handle	1726	T285
5	blades for hacksaw	1728BM	T285
1	plastic oil can 200 cc	1753	T285
1	empty thermoformed tray	VP5	VP5
1	adjustable tap wrench M3+M12	435/1,5	T273
1	adjustable tap wrench M5+M21	435/3	T273
1	reversible ratcheting tap wrench 2,0+5,0 mm (M3+M8)	436/1	T273
1	reversible ratcheting tap wrench 4,6+8,0 mm (M5+M12)	436/2	T273
1	die stock 25,4 mm	444/1	T273
1	die stock 38,1 mm	444/2	T273
1	screw pitch gauge 0,25+6 W 62+4x1"	1707	T273
26	coarse pitch hand taps M3 - 4 - 5 - 6 - 7 - 8 - 9 - 10 - 12 - 14 - 16 - 18 - 20	430	T270
14	fine pitch hand taps M6x0,75 - M8x1 - M10x1,25 - M12x1,5 - M14x1,5 - M16x1,5 - M18x1,5	433	T270
7	round dies, coarse pitch M3 - 4 - 5 - 6 - 7 - 8 - 9	440	T270
6	round dies, coarse pitch M10 - 12 - 14 - 16 - 18 - 20	440A	T270
2	round dies, fine pitch M6x0,75 - M8x0,75	441	T270
5	round dies, fine pitch M10x1,25 - M12x1,5 - M14x1,5 - M16x1,5 - M18x1,5	441A	T270



Quantity/Description

6	pin punches Ø 2 - 3 - 4 - 5 - 6 - 8 mm	31/B6
1	centre punch Ø 4 mm	32
2	flat chisels, ribbed type 125 - 250 mm	35
1	cape chisel, ribbed type 200 mm	37
30	combination wrenches 6÷41 mm	42
14	double open end wrenches 6x7 - 8x9 - 10x11 - 12x13 - 14x15 - 16x17 - 18x19 - 20x22 - 21x23 - 24x26 - 25x28 - 27x29 - 30x32 - 36x41 mm	55
13	double ended offset ring wrenches 6x7÷30x32 mm	90
14	offset hexagon key wrenches 1,5 - 2 - 2,5 - 3 - 4 - 5 - 6 - 8 - 10 - 12 - 13 - 14 - 17 - 19 mm	96N
1	adjustable wrench 250 mm	111
1	heavy duty pipe wrench 300 mm	362
25	twist drills with cylindrical shanks, short series 1÷13x0,5 mm	412/SP25
37	assortment of HSS taps and dies, metric thread	447/C37
1	click-type torque wrenches with reversible ratchets 1/2", 40÷200 Nm	666N/20
1	1/2" drive swivel T-handle	920/40
4	1/2" drive, socket drivers for hexagon screws 10-12-14-17 mm	920ME
25	20 sockets and 5 accessories	920A/C20X
17	assortment of 12 sockets and 5 accessories 3/4"	928A/C12
12	double ended hexagon/bi - hex offset socket wrenches 8 - 10 - 11 - 13 - 14 - 17 - 19 - 22 - 24 - 27 - 30 - 32 mm	932
14	T-handle wrenches with hexagon male ends 2÷14 mm	951/S14
5	T handle wrenches with swivelling hexagon male ends 3 - 4 - 5 - 6 - 8 mm	953
3	circlip pliers straight, internal 180 - 225 - 300 mm	1032
3	circlip pliers bent, internal 170 - 210 - 290 mm	1034
3	circlip pliers straight, external 140x1,3 - 175 - 225 mm	1036
3	circlip pliers bent, external 135x1,3 - 175 - 220 mm	1038
2	Slip joint pliers boxed joints 250 - 300 mm	1048
1	self locking pliers, double adjustment	1051

Beta N.

Quantity/Description

1	heavy duty diagonal cutting nippers 160 mm	1084BM
1	toggle lever assisted end cutting nippers 180 mm	1092V
1	tin snips 300 mm	1112
1	tin snip, straight narrow blades 250 mm	1114
1	electrician's scissors, straight blades	1128BMX
1	half-round needle nose pliers 180 mm	1150BM
1	extra long needle knurled nose pliers, bi-material handles 160 mm	1166BM
1	bent needle nose pliers 160 mm	1168BM
9	screwdrivers for cross head Phillips® screws 2,5x50 - 3x75 - 3,5x150 - 4x125 - 5,5x125 - 6,5x150 - 8x200 - 10x200 - 12x250 mm	1260
2	screwdrivers for slotted head screws, extra-short series 4x30 - 6,5x30 mm	1260N
5	screwdrivers for cross head Phillips® screws PH0x100 - PH1x120 - PH2x150 - PH3x150 - PH4x200 mm	1262
2	screwdrivers for cross head Phillips® screws, extra - short series PH1x30 - PH2x30 mm	1262N
7	drivers for Torx® head screws T6 - T8 - T10 - T15 - T20 - T25 - T30	1267TX
2	engineer's hammer 300 - 600 g	1370
2	soft face hammer Ø 35 - 60 mm	1390
5	tapered extractors M3÷M18	1430/S5
1	two - leg universal puller 23÷70 mm	1500N/1
1	two - leg universal puller 23÷100 mm	1500N/2
1	sliding gauge	1650
1	semirigid stainless steel rule 300 mm	1683
1	engineer's scriber	1688A
1	measuring tape 5 m	1692
1	metric feeler gauge	1708/13
1	flexible magnetic pick-up tool 1,8 kg	1712E/2
5	second cut files 200 mm	1719BMA8/S5
1	hacksaw frame, aluminium handle	1726BM
1	riveting pliers	1741B
1	metal oil can 200 cc	1751

Beta N.

1084BM
1092V
1112
1114
1128BMX
1150BM
1166BM
1168BM
1260
1260N
1262
1262N
1267TX
1370
1390
1430/S5
1500N/1
1500N/2
1650
1683
1688A
1692
1708/13
1712E/2
1719BMA8/S5
1726BM
1741B
1751

5910VI/3 059100044

Assortment recommended for use with item C30S

Industrial maintenance



Quantity/Description

16	combination wrenches 6÷21 mm
5	combination wrenches 22 - 24 - 27 - 30 - 32 mm
5	pin punches Ø 2 - 3 - 4 - 5 - 6 mm
1	centre punch Ø 4 mm
13	double open end wrenches 6x7 - 8x9 - 10x11 - 12x13 - 14x15 - 16x17 - 18x19 - 20x22 - 21x23 - 24x26 - 27x29 - 30x32 mm
9	offset hexagon key wrenches 1,5 - 2 - 2,5 - 3 - 4 - 5 - 6 - 8 - 10 mm
5	double ended offset ring wrenches 20x22 - 21x23 - 24x26 - 25x28 - 27x29 mm
7	double ended offset ring wrenches 6x7 - 8x9 - 10x11 - 12x13 - 14x15 - 16x17 - 18x19 mm
5	1/2" drive, socket drivers for hexagon screws 5 - 6 - 8 - 10 - 12 mm
1	1/2" drive extension bar 125 mm
1	1/2" drive extension bar 255 mm
1	1/2" drive universal joint
1	1/2" drive sliding T-handle
1	1/2" drive reversible ratchet
19	1/2" square drive hexagon sockets 10÷24 - 26 - 27 - 30 - 32 mm
9	screwdrivers for cross head Phillips® screws 3x75 - 3x100 - 4x100 - 4x150 - 5,5x100 - 5,5x150 - 6,5x150 - 8x150 - 10x200 mm
2	screwdrivers for slotted head screws, extra-short series 4x30 - 6,5x30 mm
7	screwdrivers for cross head Phillips® screws PH0x60 - PH0x100 - PH1x80 - PH1x120 - PH2x100 - PH2x150 - PH3x150 mm
2	screwdrivers for cross head Phillips® screws, extra - short series PH1x30 - PH2x30 mm
4	offset hexagon key wrenches 13-14-17-19 mm
1	tin snips 250 mm
1	electrician's scissors, straight blades
1	hacksaw frame, aluminium handle
(5)	blades for hacksaw
1	plastic oil can 200 cc
1	half-round needle nose pliers 180 mm
1	extra long needle knurled nose pliers, bi-material handles 160 mm
1	heavy duty diagonal cutting nippers 160 mm
1	circlip pliers straight, internal 180 mm
1	circlip pliers bent, internal 170 mm

Beta N.

Quantity/Description

42	1	circlip pliers straight, external 175mm
42	1	circlip pliers bent, external 175mm
31	2	flat chisels, ribbed type 100 - 200 mm
32	1	engineer's hammer 300 g
55	1	soft face hammer Ø 35 mm
1	1	second cut files 200 mm
96N/SC9	4	combination wrenches 35-36-38-41 mm
90	1	double open end wrenches 36x41 mm
90	1	adjustable wrench 250 mm
1	1	heavy duty pipe wrench 300 mm
920ME	25	twist drills with cylindrical shanks, short series
920/21	37	assortment of HSS taps and dies, metric thread
920/22	1	click-type torque wrenches with reversible ratchets @ 200 Nm
920/25	17	assortment of 12 sockets and 5 accessories 3/4"
920/42	14	T-handle wrenches with hexagon male ends
920/55	5	T handle wrenches with swivelling hexagon male ends 3-4-5-6-8 mm
920A	1	circlip pliers straight, internal 300 mm
1260	1	circlip pliers bent, internal 290 mm
1	1	circlip pliers straight, external 225 mm
1	1	circlip pliers bent, external 220 mm
1	1	Slip joint pliers boxed joints 300 mm
1	1	self locking pliers, double adjustment
1	1	toggle lever assisted end cutting nippers 180 mm
96N	1	engineer's hammer 600 g
1112	1	soft face hammer 60 mm
1128BM	5	tapered extractors M3-M18
1726	1	two - leg universal puller
1728BM	1	sliding gauge
1753	1	semirigid stainless steel rule
1150BM	1	engineer's scriber
1166BM	1	measuring tape 5 m
1084BM	1	metric feeler gauge
1032	1	flexible magnetic pick-up tool
1034	1	

Beta N.

1036
1038
35
1370
1390
1719BMA8/S5
42
55
111
362
412/SP25
447/C37
666N/20
928A/C12
951/S14
953
1032
1034
1036
1038
1048
1051
1092V
1370
1390
1430/S5
1500/3
1650
1683
1688
1692
1708/13
1712E/2

5935VI/1MB

assortment of 94 tools for tool chest C35, in soft foam trays

industrial maintenance



MB11

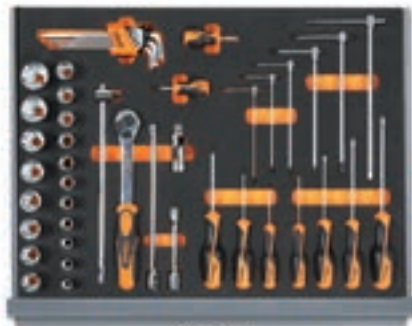

MB47



MB61

Quantity/Description

21	combination wrenches 6-7-8-9-10-11-12-13-14-15-16-17-18-19-20-21-22-24-27-30-32 mm	42	MB11
8	double open end wrenches 6x7-8x9-10x11-12x13-14x15-16x17-18x19-20x22 mm	55	MB11
1	Slip joint pliers boxed joints 250 mm	1048	MB11
4	screwdrivers for cross head Phillips® screws ● 3x75-4x100-5x125-6,5x150 mm	1260	MB47
3	screwdrivers for cross head Phillips® screws ⊕ PH0x60-PH1x80-PH2x100 mm	1262	MB47
1	screwdrivers for slotted head screws, extra-short series ● 4x30 mm	1260N	MB47
1	screwdrivers for cross head Phillips® screws, extra - short series ⊕ PH1x30 mm	1262N	MB47
6	offset hexagon key wrenches ○ 2,5-3-4-5-6-8 mm	96T	MB47
9	ball head offset hexagon key wrenches ○	96BPC/SC9	MB47
19	1/2" square drive hexagon sockets ○ 10-11-12-13-14-15-16-17-18-19-20-21-22-23-24-26-27-30-32 mm	920A	MB47
1	1/2" wobble extension bar 125 mm	920AN/125	MB47
1	1/2" wobble extension bar 250 mm	920AN/250	MB47
1	1/2" drive universal joint	920/25	MB47
1	1/2" drive sliding T-handle	920/42	MB47
1	1/2" drive reversible ratchet ⊗	920/55	MB47

Beta N. TR

Quantity/Description

1	second-cut square files 200 mm	1719BMA...Q	MB61
1	second-cut flat files 200 mm	1719BMA...P	MB61
1	second-cut triangular files 200 mm	1719BMA...T	MB61
1	second-cut half-round files 200 mm	1719BMA...M	MB61
1	second-cut round files 200 mm	1719BMA...R	MB61
1	flat chisels, ribbed type 200 mm	35	MB61
1	flat chisels, ribbed type 200 mm	1032	MB61
1	circlip pliers straight, internal ○ 180 mm	1034	MB61
1	circlip pliers bent, internal ○ 170 mm	1036	MB61
1	circlip pliers straight, external ● 175 mm	1038	MB61
1	circlip pliers bent, external ● 175 mm	1052	MB61
1	self - locking pliers 240 mm	1084BM	MB61
1	heavy duty diagonal cutting nippers ⚡ 160 mm	1150BM	MB61
1	half-round needle nose pliers = 180 mm	1166BM	MB61
1	extra long needle knurled nose pliers, bi-material handles ● 160 mm	1370	MB61
1	engineer's hammer 500 g	1390	MB61
1	soft face hammer Ø 35 mm		MB61

Beta N. TR

1719BMA...Q	MB61
1719BMA...P	MB61
1719BMA...T	MB61
1719BMA...M	MB61
1719BMA...R	MB61
35	MB61
1032	MB61
1034	MB61
1036	MB61
1038	MB61
1052	MB61
1084BM	MB61
1150BM	MB61
1166BM	MB61
1370	MB61
1390	MB61

5935VI/2MB

assortment of 133 tools for tool chest C35, in soft foam trays

industrial maintenance



MB11



MB34

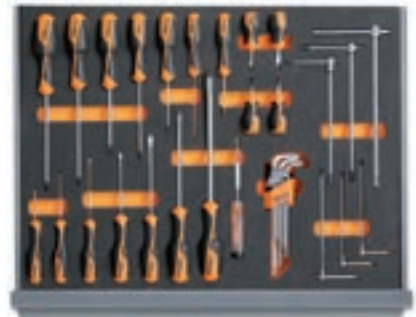

MB44



MB55

Quantity/Description	Beta N.	TR	Quantity/Description	Beta N.	TR
21 combination wrenches 6-7-8-9-10-11-12-13-14-15-16-17-18-19-20-21-22-24-27-30-32 mm	42	MB11	1 1/4" drive swivel T-handle	900/42	MB34
8 double open end wrenches 6x7-8x9-10x11-12x13-14x15-16x17-18x19-20x22 mm	55	MB11	7 screwdrivers for cross head Phillips® screws ● 2,5x50-3x75-3,5x100-4x100-5,5x125-6,5x150-8x200 mm	1260	MB44
1 Slip joint pliers boxed joints 250 mm	1048	MB11	2 screwdrivers for slotted head screws, extra-short series ● 4x30-6,5x30 mm	1260N	MB44
19 1/2" square drive hexagon sockets ○ 10-11-12-13-14-15-16-17-18-19-20-21-22-23-24-26-27-30-32 mm	920A	MB34	7 screwdrivers for cross head Phillips® screws ● PH0x60-PH0x100-PH1x80-PH1x120-PH2x100-PH2x150-PH3x150 mm	1262	MB44
1 1/2" wobble extension bar 125 mm	920AN/125	MB34	2 screwdrivers for cross head Phillips® screws, extra - short series ● PH1x30-PH2x30 mm	1262N	MB44
1 1/2" wobble extension bar 150 mm	920AN/250	MB34	1 mains testing screwdriver ● 4x30-6,5x30 mm	1253	MB44
1 1/2" drive universal joint	920/25	MB34	9 ball head offset hexagon key wrenches ○ 96BPC/SC9	951	MB44
1 1/2" drive sliding T-handle	920/42	MB34	6 T-handle wrenches with hexagon male ends ○ 2,5-3-4-5-6-8 mm	31	MB55
1 1/2" drive reversible ratchet ⊕	920/55	MB34	5 pin punches Ø 2-3-4-5-6 mm	32	MB55
1 adjustable wrench 250 mm	111	MB34	1 centre punch Ø 4 mm	35	MB55
1 self - locking pliers 240 mm	1052	MB34	1 flat chisels, ribbed type 200 mm	1112	MB55
1 heavy duty diagonal cutting nippers ⚡ 160 mm	1084BM	MB34	1 tin snips 250 mm	1128BMX	MB55
1 half-round needle nose pliers ≡ 180 mm	1150BM	MB34	1 electrician's scissors, straight blades	1370	MB55
1 extra long needle knurled nose pliers, bi-material handles ● 160 mm	1166BM	MB34	1 engineer's hammer 500 g	1390	MB55
1 circlip pliers straight, internal ○ 180 mm	1032	MB34	1 soft face hammer Ø 45 mm	1719BMA...Q	MB55
1 circlip pliers bent, internal ○ 170 mm	1034	MB34	1 second-cut square files 200 mm	1719BMA...T	MB55
1 circlip pliers straight, external ● 175 mm	1036	MB34	1 second-cut triangular files 200 mm	1719BMA...P	MB55
1 circlip pliers bent, external ● 175 mm	1038	MB34	1 second-cut flat files 200 mm	1719BMA...M	MB55
13 1/4" hexagon sockets ○ 4-4,5-5-5,5-6-7-8-9-10-11-12-13-14 mm	900	MB34	1 second-cut half-round files 200 mm	1719BMA...R	MB55
1 1/4" drive extension bar 50 mm	900/20	MB34	1 second-cut round files 200 mm	1726	MB55
1 1/4" drive extension bar 150 mm	900/21	MB34	1 hacksaw frame, aluminium handle 440 mm		
1 1/4" drive universal joint	900/25	MB34			
1 1/4" drive spinner handle	900BG/30	MB34			
1 1/4" reversible ratchet ⊕	900/55	MB34			

5935 VI/2MB

059350316

Assortment recommended in combination with C35

Industrial maintenance



17 kg

Quantity/Description

5	pin punches Ø 2-3-4-5-6 mm
1	centre punch Ø 4 mm
2	flat chisels, ribbed type 200-250 mm
18	combination wrenches 6+14 - 16 - 17 - 18 19 - 21 - 22 - 24 - 27 - 30 mm
12	double open end wrenches 6x7 - 8x9 - 10x11 - 12x13 - 14x15 - 16x17 18x19 - 20x22 - 21x23 - 24x26 - 27x29 - 30x32 mm
12	offset hexagon key wrenches \odot 2÷10 mm
1	adjustable wrench 250 mm
1	pipe wrench Swedish pattern 320 mm
20	1/2" square drive hexagon sockets \odot 10÷24 - 26 - 27 - 28 - 30 - 32 mm
6	1/2" drive, socket drivers for hexagon screws \odot 5 - 6 - 8 - 10 - 12 - 14 mm
1	1/2" drive extension bar 125 mm
1	1/2" drive extension bar 255 mm
1	1/2" drive universal joint
1	1/2" drive swivel T-handle
1	1/2" drive sliding T-handle
1	1/2" drive reversible ratchet \oplus
6	T-handle wrenches with hexagon male ends \odot 2,5 - 3 - 4 - 5 - 6 - 8 mm
2	circlip pliers straight, internal \odot 140 - 180 mm
1	circlip pliers bent, internal \odot 170 mm
2	circlip pliers straight, external \bullet 140x1,3 - 175 mm
1	circlip pliers bent, external \bullet 175 mm

Beta N.

31
32
35
42
55
96/SC12
111
374
920A
920ME
920/21
920/22
920/25
920/40
920/42
920/55
951
1032
1034
1036
1038

Quantity/Description

1	Slip joint pliers boxed joints 250 mm	1048
1	self - locking pliers 240 mm	1052
1	heavy duty diagonal cutting nippers \llcorner 160 mm	1084BM
1	toggle lever assisted end cutting nippers \llcorner 180 mm	1092V
1	tin snips 250 mm	1112
1	electrician's scissors, straight blades	1128BMX
1	half-round needle nose pliers \equiv 180 mm	1150BM
1	extra long needle knurled nose pliers, bi-material handles \bullet 160 mm	1166BM
1	mains testing screwdriver \bullet	1253
2	screwdrivers for cross head Phillips® screws \bullet 8x150 - 10x200 mm	1260
2	screwdrivers for slotted head screws, extra-short series \bullet 4x30 - 6,5x30 mm	1260N
2	screwdrivers for cross head Phillips® screws \oplus PH3x150 - PH4x200 mm	1262
2	screwdrivers for cross head Phillips® screws, extra - short series \oplus PH1x30 - PH2x30 mm	1262N
8	screwdrivers	1263/D8
2	engineer's hammer 300 - 500 g	1370
1	soft face hammer Ø 45 mm	1390
1	measuring tape 5 m	1692
1	flexible magnetic pick-up tool 0,5 kg	1712E/1
5	second cut files 200 mm	1719BMA8/ S5
1	hacksaw frame, aluminium handle	1726BM
1	plastic oil can 250 cc	1754

5954VI

059540053

Assortment recommended in combination with C54VI

Industrial maintenance



32 kg

Quantity/Description

Beta N.

Quantity/Description

Beta N.

6	pin punches Ø 2 - 3 - 4 - 5 - 6 - 8 mm	31/SP6	1	electrician's scissors, straight blades	1128BMX	
6	2 drift punches, 1 centre punch, 3 flat chisels with metal holder	38/SP6	1	half-round needle nose pliers = 180 mm	1150BM	
18	combination wrenches 6+22 - 24 - 27 - 30 - 32 mm	42	1	extra long needle knurled nose pliers, bi-material handles ● 160 mm	1166BM	
12	double open end wrenches 6x7 + 30x32 mm	55/S12X	1	bent needle nose pliers ● 160 mm	1168BM	
8	offset hexagon key wrenches 2 - 2,5 - 3 - 4 - 5 - 6 - 8 - 10 mm	96T/S8	7	screwdrivers for cross head Phillips® screws ● 2,5x50 - 3x75 - 4x100	1260	
8	offset key wrenches, for Torx® head screws ⊙ T9 - T10 - T15 - T20 - T25 - T27 - T30 - T40	97TX/SC8	5,5x125 - 6,5x150 - 8x200 - 10x200 mm	4	screwdrivers for cross head Phillips® screws ⊕ PH0x60 - PH1x80 - PH2x100 - PH3x150 mm	1262
1	adjustable wrench 250 mm	111	3	engineer's hammer 300 - 600 - 1000 g	1370	
13	1/2" square drive bi-hex sockets with rail ○ 10+22 mm	920B/SB13	1	soft face hammer Ø 35 mm	1390	
8	1/2" square drive bi-hex sockets with rail ○ 23+32 mm	920B/SB8	1	measuring tape 5 m	1692	
4	1/2" socket drivers for slotted head screws ● 1,2x6,5 - 1,2x8 - 1,6x9 - 2x12 mm	920LP	1	flexible magnetic pick-up tool 1,8 kg	1712E/2	
3	1/2" socket drivers for Phillips® screws ⊕ PH2 - 3 - 4	920PH	1	two cutting edges scraper 200 mm	1717A	
1	1/2" drive extension bar 125 mm	920/21	1	three - cutting edges scraper 200 mm	1717B	
1	1/2" drive extension bar 255 mm	920/22	5	second cut files 200 mm	1719BMA8/S5	
1	1/2" drive universal joint	920/25	1	hacksaw frame, aluminium handle	1725	
1	1/2" drive sliding T-handle	920/42	1	metal oil can 200 cc	1751	
1	1/2" drive reversible ratchet ⊗	920/55	1	flat chisels, ribbed type 200 mm	35	
1	pry bar	963	1	cape chisel, ribbed type 200 mm	37	
2	circlip pliers straight, internal ○ 140 - 180 mm	1032	11	double ended hexagon/bi - hex offset socket wrenches 8 - 10 - 11 - 12 - 13 - 14 - 16 - 17 - 19 - 22 - 24 mm	932	
2	circlip pliers bent, internal ○ 130 - 170 mm	1034	1	self - locking pliers 240 mm	1052	
2	circlip pliers straight, external ● 140 - 175 mm	1036	1	self - locking pliers 280 mm	1060	
2	circlip pliers bent, external ● 135 - 175 mm	1038	1	self - locking pliers 290 mm	1062	
1	Slip joint pliers boxed joints 250 mm	1048	1	dead blow hammer Ø 50 mm	1392	
1	self locking pliers, double adjustment	1051	1	two - leg universal puller 25+130 mm	1500N/2	
1	heavy duty diagonal cutting nippers ⚡ 160 mm	1084BM	1	sliding gauge	1650	
1	toggle lever assisted end cutting nippers ⚡ 180 mm	1092V	1	semirigid stainless steel rule 300 mm	1683	
1	tin snips 250 mm	1112	1	engineer's scriber	1688A	
1	tin snip, straight narrow blades 250 mm	1114	1	metric feeler gauge	1708/13	
			1	fold - away knife	1777BM	
			1	snap - off blade utility knife 170 mm	1771BM	
			1	diagonal cutting nippers ⚡ 160 mm	1082BM	

5957VI

059570005

Assortment recommended in combination with C57S A - C57S B - C57SP - C55PSP

5904VU/1M

assortment of 91 tools

Universal maintenance



Quantity/Description	Beta N.	TR	Quantity/Description	Beta N.	TR
16 combination wrenches 6÷21 mm	42	M15	1 heavy duty diagonal cutting nippers ∇ 160 mm	1084	M132
8 double open end wrenches 6x7 - 8x9 - 10x11 - 12x13 - 14x15 - 16x17 - 18x19 - 20x22 mm	55	M33	1 half-round needle nose pliers \equiv 180 mm	1150	M132
9 offset hexagon key wrenches \odot 1,5 - 2 - 2,5 - 3 - 4 - 5 - 6 - 8 - 10 mm	96/SC9	M33	1 screwdrivers for slotted head screws \bullet 160 mm	1166	M132
7 screwdrivers for cross head Phillips® screws \bullet 2,5x50 - 3x75 - 3,5x100 - 4x125 - 5,5x100 - 5,5x150 - 6,5x150 mm	1260	M199	1 Slip joint pliers boxed joints 250 mm	1048	M153
6 screwdrivers for cross head Phillips® screws \oplus PH0x60 - PH0x100 - PH1x80 - PH1x120 - PH2x100 - PH2x150 mm	1262	M202	1 self - locking pliers 240 mm	1052	M153
8 offset hexagon key wrenches \odot 2-2,5-3-4-5-6-7-8 mm	96T	M50	2 flat chisels, ribbed type 100 - 200 mm	35	M234
1 1/2" wobble extension bar 125 mm	920AN/125	M83	1 engineer's hammer 300 g	1370	M234
1 1/2" wobble extension bar 250 mm	920AN/250	M83	1 soft face hammer \varnothing 35 mm	1390	M234
1 1/2" drive universal joint	920/25	M83	1 circlip pliers straight, internal \odot 180 mm	1032	M145
1 1/2" drive sliding T-handle	920/42	M83	1 circlip pliers bent, internal \odot 170 mm	1034	M145
1 1/2" drive reversible ratchet \oplus	920/55	M83	1 circlip pliers straight, external \bullet 175 mm	1036	M145
19 1/2" square drive hexagon sockets \odot 10÷24 - 26 - 27 - 30 - 32 mm	920A	M83	1 circlip pliers bent, external \bullet 175 mm	1038	M145

5904 VU/1M

059040201

Assortment recommended in combination with C24S - C24SA - C24SA-XL - C37 - C39 with 6 - 7 - 8 drawers
C23ST - C39T - C24SL - C24SL/CAB - C59 - C55 - C28 - C39SM - C39MD

Universal maintenance



M15 M33 M199 M202



M50 M83



M132 M153 M237 M145



M204 M289 M85 M236

Quantity/Description

- 16 combination wrenches 6÷21 mm
- 8 double open end wrenches 6x7 - 8x9 - 10x11 - 12x13 - 14x15 - 16x17 - 18x19 - 20x22 mm
- 9 offset hexagon key wrenches
 ○ 1,5 - 2 - 2,5 - 3 - 4 - 5 - 6 - 8 - 10 mm
- 7 screwdrivers for cross head Phillips® screws ● 2,5x50 - 3x75 - 3,5x100 - 4x125 - 5,5x100 - 5,5x150 - 6,5x150 mm
- 6 screwdrivers for cross head Phillips® screws ⊕ PH0x60 - PH0x100 - PH1x80 - PH1x120 - PH2x100 - PH2x150 mm
- 8 offset hexagon key wrenches ○ 2-2,5-3-4-5-6-7-8 mm
- 1 1/2" wobble extension bar 125 mm
- 1 1/2" wobble extension bar 250 mm
- 1 1/2" drive universal joint
- 1 1/2" drive sliding T-handle
- 1 1/2" drive reversible ratchet ⊕
- 19 1/2" square drive hexagon sockets
 ○ 10÷24 - 26 - 27 - 30 - 32 mm
- 1 heavy duty diagonal cutting nippers ✂ 160 mm
- 1 half-round needle nose pliers = 180 mm
- 1 screwdrivers for slotted head screws ● 160 mm
- 1 Slip joint pliers boxed joints 250 mm
- 1 self - locking pliers 240 mm
- 2 flat chisels, ribbed type 100 - 200 mm
- 1 mechanic's hammers 300 g
- 1 nylon face hammers, wooden shafts Ø 35 mm
- 1 circlip pliers straight, internal ○ 180 mm

Beta N.	TR
42	M15
55	M33
96/SC9	M33
1260	M199
1262	M202
96T	M50
920AN/125	M83
920AN/250	M83
920/25	M83
920/42	M83
920/55	M83
920A	M83
1084	M132
1150	M132
1166	M132
1048	M153
1052	M153
35	M237
1370T	M237
1390N	M237
1032	M145

Quantity/Description

- 1 circlip pliers bent, internal ○ 170 mm
- 1 circlip pliers straight, external ● 175 mm
- 1 circlip pliers bent, external ● 175 mm
- 6 drivers for Torx® head screws ⊕ T8-T10-T15-T20-T25-T30
- 1 measuring tape 5 m
- 1 mini hacksaw frame
- 1 plastic oil bottle 30 cc
- 1 snap - off blade utility knife
- 5 bits for slotted head screws, coloured
 ● 0,5x3 - 0,6x4,5 - 0,8x5,5 - 1x5,5 - 1,2x6,5 mm
- 8 hexagon bits for power drivers, coloured
 ○ 2 - 2,5 - 3 - 4 - 5 - 6 - 8 - 10 mm
- 5 bits for cross head Phillips® screws, coloured
 ⊕ PH0 - PH1 - PH2 - PH3 - PH4
- 4 bits for cross head Pozidriv® - Supadriv® screws, coloured ⊕ PZ1 - PZ2 - PZ3 - PZ4
- 11 bits for Torx® head screws, coloured ⊕ T6-T7-T8-T9-T10-T15-T20-T25-T27-T30-T40
- 8 bits for Tamper Resistant Torx® head screws, coloured ⊕ T9-T10-T15-T20-T25-T27-T30-T40
- 1 magnetic bit holder with handle 230 mm
- 1 reversible bit ratchet 100 mm
- 5 second cut files 200 mm
- 1 adaptors for drivers
- 1 magnetic bit holder extension bar

Beta N.	TR
1034	M145
1036	M145
1038	M145
1267TX	M204
1692	M289
1725CR	M289
1755	M289
1771	M289
860LP	M85
860PE	M85
860PH	M85
860PZ	M85
860TX	M85
860RTX	M85
851SR	M85
860/55	M85
1719BMA8/S5	M236
892/0	M85
882P	M85

5904VU/2T

assortment of 104 tools in foam trays

Universal use



T199 T202 T83



T145 T153 T131 T234



T68 T33 T15 T16



T284

Quantity/Description

- 7 screwdrivers for cross head Phillips® screws ● 2,5x50 - 3x75 - 3,5x100 - 4x125-5,5x100 - 5,5x150 - 6,5x150 mm
- 6 screwdrivers for cross head Phillips® screws ● PH0x60 - PH0x100 - PH1x80 - PH1x120 - PH2x100 - PH2x150 mm
- 19 1/2" square drive hexagon sockets ○ 10-11-12-13-14-15-16-17-18-19-20-21-22-23-24-26-27-30-32 mm
- 1 1/2" drive extension bar 125 mm
- 1 1/2" drive extension bar 255 mm
- 1 1/2" drive universal joint
- 1 1/2" drive sliding T-handle 305 mm
- 1 1/2" drive reversible ratchet Ⓞ
- 1 circlip pliers straight, internal ○ 180 mm
- 1 circlip pliers bent, internal ○ 170 mm
- 1 circlip pliers straight, external ● 175 mm
- 1 circlip pliers bent, external ● 175 mm
- 1 Slip joint pliers boxed joints 250 mm
- 1 self - locking pliers 240 mm
- 1 heavy duty diagonal cutting nippers ⚡ 160 mm
- 1 half-round needle nose pliers = 180 mm
- 1 extra long needle knurled nose pliers, bi-material handles ● 160 mm

Beta N. TR

- 1260 T199
- 1262 T202
- 920A T83
- 920/21 T83
- 920/22 T83
- 920/25 T83
- 920/42 T83
- 920/55 T83
- 1032 T145
- 1034 T145
- 1036 T145
- 1038 T145
- 1048 T153
- 1052 T153
- 1084BM T131
- 1150BM T131
- 1166BM T131

Quantity/Description

- 2 flat chisels, ribbed type 100-200 mm
- 1 engineer's hammer 300 g
- 1 soft face hammer Ø 35 mm
- 6 T-handle wrenches with hexagon male ends ○ 2,5-3-4-5-6-8 mm
- 8 double open end wrenches 6x7-8x9-10x11-12x13-14x15 16x17-18x19-20x22 mm
- 9 offset hexagon key wrenches ○ 1,5+10 mm
- 16 combination wrenches 6-7-8-9-10-11-12-13-14-15-16-17 18-19-20-21 mm
- 5 combination wrenches 22-24-27-30-32 mm
- 1 electrician's scissors, straight blades
- 1 Multiuse scissors
- 1 second-cut square files 200 mm
- 1 second-cut flat files 200 mm
- 1 second-cut triangular files 200 mm
- 1 second-cut half-round files 200 mm
- 1 second-cut round files 200 mm
- 1 hacksaw frame, aluminium handle
- 1 blades for hacksaw
- 1 snap - off blade utility knife 170 mm
- 1 foldaway knife 185 mm

Beta N. TR

- 35 T234
- 1370 T234
- 1390 T234
- 951 T68
- 55 T33
- 96/SC9 T33
- 42 T15
- 42 T16
- 1128BMX T284
- 1130BMX T284
- 1719BMA...Q T284
- 1719BMA...P T284
- 1719BMA...T T284
- 1719BMA...M T284
- 1719BMA...R T284
- 1726BM T284
- 1728BM T284
- 1771BM T284
- 1778 T284

5904VU/2T

059040070

Assortment recommended in combination with C24S - C24SA - C37 - C39 C24SL - C24SL/CAB - C59 - C55 - C23ST - C28 - C39SM - C39MD - C39T

Universal maintenance



T15 T16 T31



T52 T55 T80



T91 T145 T132 T153



T198 T205 T234 T236

Quantity/Description

16	combination wrenches 6÷21 mm
5	combination wrenches 22 - 24 - 27 - 30 - 32 mm
5	pin punches Ø 2 - 3 - 4 - 5 - 6 mm
1	centre punch Ø 4 mm
12	double open end wrenches 6x7 - 8x9 - 10x11 - 12x13 - 14x15 - 16x17 - 18x19 - 20x22 - 21x23 - 24x26 - 27x29 - 30x32 mm
9	offset hexagon key wrenches ○ 1,5 - 2 - 2,5 - 3 - 4 - 5 - 6 - 8 - 10 mm
6	offset hexagon key wrenches ○ 2 - 2,5 - 3 - 4 - 5 - 6 mm
6	drivers for Torx® head screws, with handles ⊕ T10-T15-T20-T25-T27-T30
5	1/2" drive, socket drivers for hexagon screws ○ 5 - 6 - 8 - 10 - 12 mm
1	1/2" drive extension bar 125 mm
1	1/2" drive extension bar 255 mm
1	1/2" drive universal joint
1	1/2" drive sliding T-handle
1	1/2" drive reversible ratchet ⊕
19	1/2" square drive hexagon sockets ○ 10÷24 - 26 - 27 - 30 - 32 mm
13	1/4" hexagon sockets ○ 4-4,5-5-5,5-6-7-8-9-10-11-12-13-14 mm
6	1/4" socket drivers for hexagon screws ○ 2,5-3-4-5-6-8 mm
1	1/4" drive extension bar 50 mm
1	1/4" drive extension bar 150 mm
1	1/4" drive universal joint
1	1/4" drive spinner handle
1	1/4" drive swivel T-handle 115 mm

Beta N. TR

42	T15
42	T16
31	T31
32	T31
55	T31
96N/SC9	T31
96T	T52
97TTX	T55
920ME	T80
920/21	T80
920/22	T80
920/25	T80
920/42	T80
920/55	T80
920A	T80
900	T91
900ME	T91
900/20	T91
900/21	T91
900/25	T91
900BG/30	T91
900/42	T91

Quantity/Description

1	1/4" reversible ratchet ⊕
1	circlip pliers straight, internal ○ 180 mm
1	circlip pliers bent, internal ○ 170 mm
1	circlip pliers straight, external ● 175 mm
1	circlip pliers bent, external ● 175 mm
1	half-round needle nose pliers = 180 mm
1	screwdrivers for slotted head screws ● 160 mm
1	heavy duty diagonal cutting nippers ⚡ 160 mm
1	Slip joint pliers boxed joints 250 mm
1	self - locking pliers 240 mm
4	screwdrivers for cross head Phillips® screws ● 3x75 - 4x100 - 5,5x150 - 6,5x150 mm
3	screwdrivers for cross head Pozidriv®-Supadriv® screws ⊕ PZ0 - PZ1 - PZ2
7	drivers for Torx® head screws ⊕ T6-T7-T8-T9-T10-T15-T20
2	flat chisels, ribbed type 100 - 200 mm
1	engineer's hammer 300 g
1	soft face hammer Ø 35 mm
5	second cut files 200 mm

Beta N. TR

900/55	T91
1032	T145
1034	T145
1036	T145
1038	T145
1150	T132
1166	T132
1084	T132
1048	T153
1052	T153
1260	T198
1269PZ	T198
1267TX	T205
35	T234
1370	T234
1390	T234
1719BMA8/S5	T236

5914VU/M

assortment of 109 tools for tool trolley C14, in soft foam tray

Universal use

















MC T1



MC T2



MC T3

Quantity/Description	Beta N.	TR	Quantity/Description	Beta N.	TR
31 bits with magnetic quick release bit holder in plastic case    	860MIX/A31	MCT1	9 offset hexagon key wrenches 	96/SC9	MCT2
1 socket holder	895/1	MCT1	1 adjustable wrench 250 mm	111	MCT2
13 1/4" hexagon sockets  4-4,5-5,5-6-7-8-9-10-11-12-13-14 mm	900	MCT1	1 electrician's scissors, straight blades	1128BMX	MCT2
1 1/4" drive extension bar 150 mm	900/...	MCT1	1 measuring tape 5 mt	1692/5	MCT2
1 1/4" drive universal joint	900/25	MCT1	1 snap - off blade utility knife	1771	MCT2
1 1/4" drive spinner handle	900BG/30C	MCT1	1 Slip joint pliers boxed joints 250 mm	1048	MCT3
1 1/4" drive swivel T-handle	900/42	MCT1	1 diagonal cutting nippers  160 mm	1082BM	MCT3
1 1/4" reversible ratchet 	900/55	MCT1	1 half-round needle nose pliers  180 mm	1150BM	MCT3
16 1/2" square drive hexagon sockets  10-11-12-13-14-15-16-17-18-19-21-22-24-27-30-32 mm	920A	MCT1	1 extra long needle knurled nose pliers, bi-material handles  160 mm	1166BM	MCT3
1 1/2" drive universal joint	920/25	MCT1	3 screwdrivers for cross head Phillips® screws	1260	MCT3
1 1/2" wobble extension bar	920AN/125	MCT1	 3,5x100-5,5x125-6,5x150 mm		
1 1/2" drive sliding T-handle	920/42	MCT1	3 screwdrivers for cross head Phillips® screws	1262	MCT3
1 1/2" drive reversible ratchet 	920/55	MCT1	 PHx60-PH1x80-PH3x100 mm		
16 combination wrenches 6-7-8-9-10-11-12-13-14-15-16-17-18-19-21-22 mm	42	MCT2			

5915VU/0

Assortment of 35 tools

Universal use



Quantity/Description

1	centre punch 4 mm	32
1	flat chisels, ribbed type 125 mm	35
8	double open end wrenches 6x7-8x9-10x11-12x13-14x15-16x17-18x19-20x22 mm	55
7	Offset hexagon key wrenches \odot 1,5-2-2,5-3-4-5-6 mm	96/BGS7
1	adjustable wrench 150 mm	111
1	Slip joint pliers boxed joints 250 mm	1048
1	diagonal cutting nippers ∇ 160 mm	1082
1	electrician's scissors, straight blades	1128BMX
1	half-round needle nose pliers \equiv 180 mm	1150

Beta N.

Quantity/Description

1	screwdrivers for slotted head screws \bullet 160 mm	1166
4	screwdrivers for cross head Phillips® screws \bullet 3x75-4x100-5,5x100-6,5x150 mm	1201
3	screwdrivers for cross head Phillips® screws \oplus PH0x60-PH1x80-PH2x100 mm	1202
1	engineer's hammer 300 g	1370
1	measuring tape 3 m	1692/3
1	snap - off blade utility knife 18 mm	1771
1	car service knife	1778SOS
1	high-brightness LED torch	1834PS

Beta N.

5915VU/0

059150021

Assortment recommended in combination with C4 - C5 - C6T

5915VU/1

Assortment of 45 tools

Universal use



5 kg

Quantity/Description

- 2 drift punches Ø 2-3 mm
- 1 centre punch Ø 4 mm
- 2 flat chisels 125-150 mm
- 1 cape chisels, standard type 150 mm
- 14 combination wrenches 6+14 - 17 - 19 - 21 - 22 - 24 mm
- 9 offset hexagon key wrenches
Ø 1,5 - 2 - 2,5 - 3 - 4 - 5 - 6 - 8 - 10 mm
- 1 adjustable wrench 250 mm
- 1 Slip joint pliers boxed joints 250 mm
- 1 diagonal cutting nippers 160 mm
- 1 electrician's scissors, straight blades

Beta N.

- 30
- 32
- 34
- 36
- 42
- 96/SC9
- 111
- 1048
- 1082
- 1128BMX

Quantity/Description

- 1 half-round needle nose pliers 180 mm
- 1 screwdrivers for slotted head screws 160 mm
- 4 screwdrivers for cross head Phillips® screws
● 3x75 - 4x100 - 5,5x100 - 6,5x150 mm
- 3 screwdrivers for cross head Phillips® screws
⊕ PH0x60 - PH1x80 - PH2x100 mm
- 1 engineer's hammer 300 g
- 1 measuring tape 5 m
- 1 snap - off blade utility knife

Beta N.

- 1150
- 1166
- 1201
- 1202
- 1370
- 1692
- 1771

5915VU/1

059150024

Assortment recommended in combination with C9 - C10 - C10S - C11 - CP15-CP15L - C16 - CP17 - CP17L - C18

5915VU/2

Assortment of 49 tools

Universal use



Quantity/Description

- 8 double open end wrenches 6x7 - 8x9 - 10x11 - 12x13 - 14x15 - 16x17 - 18x19 - 20x22 mm
- 9 offset hexagon key wrenches
 - 1,5 - 2 - 2,5 - 3 - 4 - 5 - 6 - 8 - 10 mm
- 13 1/4" hexagon sockets ○ 4 - 4,5 - 5 - 5,5 - 6 - 7 - 8 - 9 - 10 - 11 - 12 - 13 - 14 mm
- 1 1/4" drive extension bar 150 mm
- 1 1/4" drive universal joint
- 1 1/4" drive spinner handle
- 1 1/4" drive swivel T-handle
- 1 1/4" reversible ratchet Ⓞ

Beta N.

- 55/B8
- 96/SC9
- 900
- 900/21
- 900/25
- 900BG/30
- 900/42
- 900/55

Quantity/Description

- 1 Slip joint pliers boxed joints 250 mm
- 1 electrician's scissors, straight blades
- 1 half-round needle nose pliers = 180 mm
- 4 screwdrivers for cross head Phillips® screws
 - 3x75 - 4x100 - 5,5x150 - 6,5x150 mm
- 3 screwdrivers for cross head Phillips® screws
 - ⊕ PH0x60 - PH1x80 - PH2x100 mm
- 1 engineer's hammer 300 g
- 1 measuring tape 3 m
- 1 plastic oil bottle 30 cc
- 1 snap - off blade utility knife 18 mm

Beta N.

- 1048
- 1128BMX
- 1150
- 1201
- 1202
- 1370
- 1692
- 1755
- 1771

5915VU/2

059150027

Assortment recommended in combination with C7 - CP15 - C20 - C20L

5915VU/3

assortment of 74 tools

Universal use



8.1 kg

Quantity/Description

- 1 pin punches Ø 4 mm
- 1 centre punch Ø 4 mm
- 1 flat chisels 150 mm
- 14 combination wrenches 6÷17 - 19 - 22 - 24 mm
- 9 offset hexagon key wrenches \odot 1,5÷10 mm
- 3 offset hexagon key wrenches \odot 4 - 5 - 6 mm
- 1 adjustable wrench 250 mm
- 13 1/2" square drive hexagon sockets \odot 8÷17 - 19 - 22 - 24 mm
- 1 1/2" drive extension bar 255 mm
- 1 1/2" drive universal joint
- 1 1/2" drive sliding T-handle
- 1 1/2" drive reversible ratchet \otimes
- 8 double ended hexagon tubular socket wrenches, light series 6x7 - 8x9 - 10x11 - 12x13 - 14x15 - 16x17 - 18x19 - 20x22 mm
- 2 tommy bars for tubular wrenches
- 1 slip joint pliers 250 mm

Beta N.

- 31
- 32
- 34
- 42
- 96/SC9
- 96T
- 111
- 920A
- 920/22
- 920/25
- 920/42
- 920/55
- 935
- 940
- 1048V

Quantity/Description

- 1 self - locking pliers 240 mm
- 1 heavy duty diagonal cutting nippers ∇ 160 mm
- 1 electrician's scissors, straight blades
- 1 half-round needle nose pliers \equiv 180 mm
- 1 extra long needle knurled nose pliers, bi-material handles \bullet 160 mm
- 4 screwdrivers for cross head Phillips® screws \bullet 3x75 - 4x100 - 5,5x150 - 6,5x150 mm
- 3 screwdrivers for cross head Phillips® screws \oplus PH0x60 - PH1x80 - PH2x100 mm
- 1 engineer's hammer 400 g
- 1 measuring tape 5 m
- 1 hacksaw frame, aluminium handle
- 1 plastic oil bottle 150 cc
- 1 snap - off blade utility knife

Beta N.

- 1052
- 1084BM
- 1128BMX
- 1150BM
- 1166BM
- 1201
- 1202
- 1370
- 1692
- 1726
- 1755
- 1771

5915VU/3

059150028

Assortment recommended in combination with C7 - C9 - C10 - C10S - C11 - CP15L - C16 - CP17 - CP17L - C19 - C19L - C20 - C20L

Universal use



11.2 kg

Quantity/Description

- 1 pin punches Ø 4 mm
- 1 centre punch Ø 4 mm
- 1 flat chisels 150 mm
- 15 combination wrenches 6+17 - 19 - 22 - 24 mm
- 9 offset hexagon key wrenches \odot 1,5+10 mm
- 1 adjustable wrench 250 mm
- 13 1/2" square drive hexagon sockets \odot 8+17 - 19 - 22 - 24 mm
- 1 1/2" drive extension bar 255 mm
- 1 1/2" drive universal joint
- 1 1/2" drive sliding T-handle
- 1 1/2" drive reversible ratchet \otimes
- 17 double ended hexagon/bi - hex offset socket wrenches 6+22 mm
- 1 Slip joint pliers boxed joints 250 mm
- 1 self - locking pliers 240 mm

Beta N.

- 31
- 32
- 34
- 42
- 96/SC9
- 111
- 920A
- 920/22
- 920/25
- 920/42
- 920/55
- 932/S17
- 1048
- 1052

Quantity/Description

- 1 heavy duty diagonal cutting nippers \leq 160 mm
- 1 electrician's scissors, straight blades
- 1 half-round needle nose pliers \equiv 180 mm
- 1 extra long needle knurled nose pliers, bi-material handles \bullet 160 mm
- 4 screwdrivers for cross head Phillips® screws \bullet 3x75 - 4x100 - 5,5x150 - 6,5x150 mm
- 3 screwdrivers for cross head Phillips® screws \oplus PH0x60 - PH1x80 - PH2x100 mm
- 1 riveting hammer 32 mm
- 1 measuring tape 5 m
- 1 hacksaw frame, aluminium handle
- 1 plastic oil bottle 150 cc
- 1 snap - off blade utility knife

Beta N.

- 1084BM
- 1128BMX
- 1150BM
- 1166BM
- 1201
- 1202
- 1370F
- 1692
- 1726
- 1755
- 1771

5915VU/4

059150045

Assortment recommended in combination with C20 - C20L

5915VU/5

assortment of 111 tools

Universal use



Quantity/Description

- 1 pin punches Ø 4 mm
- 1 centre punch Ø 4 mm
- 1 flat chisels 150 mm
- 17 combination wrenches 6-7-8-9-10-11-12-13-14-15-16-17-18-19-20-21-22 mm
- 8 double open end wrenches 6x7-8x9-10x11-12x13-14x15-16x17-18x19-20x22 mm
- 9 ball head offset hexagon key wrenches ○
- 1 adjustable wrench 250 mm
- 39 11 hexagon sockets, 20 bits and 8 accessories
- 13 11 sockets and 2 accessories
- 1 Slip joint pliers boxed joints 250 mm
- 1 self - locking pliers 240 mm
- 1 diagonal cutting nippers ✂ 160 mm
- 1 construction worker's pincers 220 mm

Beta N.

- 31
- 32
- 34
- 42
- 55/S8
- 96BPC/SC9
- 111
- 900/C11
- 920A/C11
- 1048
- 1052
- 1082
- 1098

Quantity/Description

- 1 electrician's scissors, straight blades
- 1 half-round needle nose pliers = 180 mm
- 1 screwdrivers for slotted head screws ● 160 mm
- 3 screwdrivers for cross head Phillips® screws
 - PH0x60 - PH1x80 - PH2x100 mm
- 1 engineer's hammer 300 g
- 1 soft face hammer Ø 35 mm
- 1 measuring tape 3 m
- 1 second cut files
- 1 hacksaw frame, aluminium handle 440 mm
- 1 snap - off blade utility knife 18 mm
- 1 LED inspection torch
- 4 screwdrivers for cross head Phillips® screws
 - 3x75 - 4x100 - 5,5x100 - 6,5x150 mm

Beta N.

- 1128BMX
- 1150
- 1166
- 1202
- 1370
- 1390
- 1692/3
- 1719BMA8/M
- 1726
- 1771BM
- 1835/2
- 1201

5915VU/5

059150046

Assortment recommended in combination with C12 - C41S - C41H - C42S - C42H

5915VU/AS

assortment of 68 tools

Universal use



9.3 kg

Quantity/Description

- 1 pin punches Ø 4 mm
- 1 centre punch Ø 4 mm
- 1 flat chisels 150 mm
- 13 combination wrenches 1/4 - 5/16 - 3/8 - 7/16 - 1/2 - 9/16 - 5/8 - 11/16 - 3/4 - 13/16 - 7/8 - 15/16 - 1"
- 8 double ended offset ring wrenches 1/4"÷1"
- 9 offset hexagon key wrenches, burnished ○ 3/64"÷3/8"
- 1 adjustable wrench 250 mm
- 11 1/2" square drive bi - hex sockets ○ 3/8 - 7/16 - 1/2 - 9/16 - 5/8 - 11/16 - 3/4 - 13/16 - 7/8 - 15/16 - 1"
- 1 1/2" drive extension bar 125 mm
- 1 1/2" drive extension bar 255 mm
- 1 1/2" drive universal joint
- 1 1/2" drive sliding T-handle
- 1 1/2" drive reversible ratchet Ⓜ
- 1 Slip joint pliers boxed joints 250 mm

Beta N.

- 31
- 32
- 34
- 42AS
- 90AS/8
- 96AS/SC9
- 111
- 920AS
- 920/21
- 920/22
- 920/25
- 920/42
- 920/55
- 1048

Quantity/Description

- 1 self - locking pliers 240 mm
- 1 heavy duty diagonal cutting nippers 160 mm
- 1 electrician's scissors, straight blades
- 1 half-round needle nose pliers = 180 mm
- 1 extra long needle knurled nose pliers, bi-material handles ● 160 mm
- 4 screwdrivers for cross head Phillips® screws
 - 3x75 - 4x100 - 5,5x150 - 6,5x150 mm
- 3 screwdrivers for cross head Phillips® screws
 - ⊕ PH0x60 - PH1x80 - PH2x100 mm
- 1 engineer's hammer 300 g
- 1 measuring tape 5 m
- 1 hacksaw frame, aluminium handle
- 1 plastic oil bottle 150 cc
- 1 snap - off blade utility knife

Beta N.

- 1052
- 1084BM
- 1128BMX
- 1150BM
- 1166BM
- 1201
- 1202
- 1370
- 1692
- 1726
- 1755
- 1771

5915VU/AS

059150032

Assortment recommended in combination with C10 - C20 - C20L

5927VU/M

assortment of 108 tools in soft foam tray

Universal use



MC10



MC20

Quantity/Description

Quantity/Description	Beta N.	TR
16 combination wrenches 6-7-8-9-10-11-12-13-14-15-16-17-18-19-21-22 mm	42	MC10
9 offset hexagon key wrenches \odot 1,5-2-2,5-3-4-5-6-8-10 mm	96/SC9	MC10
1 heavy duty diagonal cutting nippers \ddagger 160 mm	1084BM	MC10
1 half-round needle nose pliers \equiv 180 mm	1150BM	MC10
1 extra long needle knurled nose pliers, bi-material handles \bullet 160 mm	1166BM	MC10
3 screwdrivers for cross head Phillips® screws \bullet 3,5x100-5,5x150-6,5x150 mm	1201	MC10
3 screwdrivers for cross head Phillips® screws \oplus PH0x3x60-PH1x4,5x80-PH2x6x100 mm	1202	MC10
31 bits with magnetic quick release bit holder in plastic case \bullet \odot \oplus \oplus \oplus	860MIX/A31	MC20
1 Slip joint pliers boxed joints 250 mm	1048	MC20
1 engineer's hammer 300 mm	1370	MC20
1 centre punch 4 mm	32	MC20

Quantity/Description

Quantity/Description	Beta N.	TR
1 cape chisels, standard type 4 mm	36	MC20
13 1/4" hexagon sockets \odot 4-4,5-5-5,5-6-7-8-9-10-11-12-13-14 mm	900	MC20
1 1/4" drive extension bar 150 mm	900/21	MC20
1 1/4" drive universal joint	900/25	MC20
1 1/4" drive spinner handle	900BG/30C	MC20
1 1/4" drive swivel T-handle	900/42	MC20
1 1/4" reversible ratchet \oplus	900/55	MC20
16 1/2" square drive hexagon sockets \odot 10-11-12-13-14-15-16-17-18-19-21-22-24-27-30-32 mm	920A	MC20
1 1/2" drive universal joint	920/25	MC20
1 1/2" wobble extension bar 125 mm	920AN/125	MC20
1 1/4" drive swivel T-handle	900/42	MC20
1 1/4" reversible ratchet \oplus	900/55	MC20
1 socket holder	895/1	MC20

5927 VU/M

059270021

Assortment recommended in combination with C22S - C27S - C23S - C23SC

5935VU/1MB

assortment of 154 tools for tool chest C35, in soft foam trays

Universal use



MB11



MB35



MB45



MB56

Quantity/Description

- 21 combination wrenches 6-7-8-9-10-11-12-13-14-15-16-17-18-19-20-21-22-24-27-30-32 mm
- 8 double open end wrenches 6x7-8x9-10x11-12x13-14x15-16x17-18x19-20x22 mm
- 1 Slip joint pliers boxed joints 250 mm
- 8 offset hexagon key wrenches \odot 2-2,5-3-4-5-6-7-8 mm
- 1 magnetic bit holder with handle 230 mm
- 5 bits for slotted head screws, coloured \bullet 0,5x3 - 0,6x4,5 - 0,8x5,5 - 1x5,5 - 1,2x6,5 mm
- 8 hexagon bits for power drivers, coloured \odot 2 - 2,5 - 3 - 4 - 5 - 6 - 8 - 10 mm
- 5 bits for cross head Phillips® screws, coloured \oplus PH0 - PH1 - PH2 - PH3 - PH4
- 4 bits for cross head Pozidriv® - Supadriv® screws, coloured \oplus PZ1 - PZ2 - PZ3 - PZ4
- 8 bits for Tamper Resistant Torx® head screws, coloured \otimes T9-T10-T15-T20-T25-T27-T30-T40
- 11 bits for Torx® head screws, coloured \odot T6-T7-T8-T9-T10-T15-T20-T25-T27-T30-T40
- 1 reversible bit ratchet 100 mm
- 1 magnetic bit holder extension bar 80 mm
- 1 adaptors for drivers
- 18 1/2" square drive hexagon sockets \odot 10-11-12-13-14-15-16-17-18-19-20-21-22-24-26-27-30-32 mm
- 1 1/2" wobble extension bar 125 mm
- 1 1/2" wobble extension bar 250 mm
- 1 1/2" drive universal joint
- 1 1/2" drive sliding T-handle
- 1 1/2" drive reversible ratchet \otimes
- 1 heavy duty diagonal cutting nippers \nless 160 mm
- 1 half-round needle nose pliers \equiv 180 mm
- 1 extra long needle knurled nose pliers, bi-material handles \bullet 160 mm

Beta N. TR

- 42 **MB11**
- 55 **MB11**
- 1048 **MB11**
- 96T **MB35**
- 851SR **MB35**
- 860LP **MB35**
- 860PE **MB35**
- 860PH **MB35**
- 860PZ **MB35**
- 860RTX **MB35**
- 860TX **MB35**
- 860/55 **MB35**
- 882P **MB35**
- 892/0 **MB35**
- 920A **MB35**
- 920AN/125 **MB35**
- 920AN/250 **MB35**
- 920/25 **MB35**
- 920/42 **MB35**
- 920/55 **MB35**
- 1084BM **MB35**
- 1150BM **MB35**
- 1166BM **MB35**

Quantity/Description

- 7 screwdrivers for cross head Phillips® screws \bullet 2,5x50-3x75-3,5x100-4x100-5,5x100-5x125-6,5x150 mm
- 6 screwdrivers for cross head Phillips® screws \oplus PH0x60-PH0x100-PH1x80-PH1x120-PH2x100-PH2x150 mm
- 6 drivers for Torx® head screws \otimes T8-T10-T15-T20-T25-T30
- 1 self - locking pliers 240 mm
- 9 ball head offset hexagon key wrenches \odot
- 1 second-cut square files 200 mm
- 1 second-cut triangular files 200 mm
- 1 second-cut flat files 200 mm
- 1 second-cut half-round files, with handles 200 mm
- 1 second-cut round files 200 mm
- 1 circlip pliers straight, internal \odot 180 mm
- 1 circlip pliers bent, internal \odot 170 mm
- 1 circlip pliers straight, external \bullet 175 mm
- 1 circlip pliers bent, external \bullet 175 mm
- 1 mechanic's hammers 300 g
- 1 nylon face hammers, wooden shafts \varnothing 35 mm
- 1 flat chisels, ribbed type 200 mm
- 1 measuring tape 5 mt
- 1 hacksaw frame, aluminium handle 260 mm
- 1 snap - off blade utility knife 18 mm

Beta N. TR

- 1260 **MB45**
- 1262 **MB45**
- 1267TX **MB45**
- 1052 **MB45**
- 96BPC/SC9 **MB45**
- 1719BMA...Q **MB56**
- 1719BMA...T **MB56**
- 1719BMA...P **MB56**
- 1719BMA...M **MB56**
- 1719BMA...R **MB56**
- 1032 **MB56**
- 1034 **MB56**
- 1036 **MB56**
- 1038 **MB56**
- 1370T **MB56**
- 1390N **MB56**
- 35 **MB56**
- 1692 **MB56**
- 1725 **MB56**
- 1771 **MB56**

Universal maintenance



Quantity/Description	Beta N.	TR	Quantity/Description	Beta N.	TR
7 screwdrivers for cross head Phillips® screws ● 2,5x50 - 3x75 - 3,5x100 - 4x125 - 5,5x100 - 5,5x150 - 6,5x150 mm	1201	T210	3 bits for cross head Pozidriv®-Supadriv® screws ● PZ1 - PZ2 - PZ3	861PZ	T85
6 screwdrivers for cross head Phillips® screws ● PH0x60- PH1x80-PH1x120-PH2x100-PH2x150-PH3x150 mm	1202	T212	4 bits for cross head Phillips® screws ● PH0 - PH1 - PH2 - PH3	861PH	T85
7 drivers for Torx® head screws, with handles ○ T6-T7-T8-T9-T10-T15-T20	1207TX	T215	8 hexagon bits for power drivers ○ 2 - 2,5 - 3 - 4 - 5 - 6 - 8 - 10 mm	861PE	T85
1 circlip pliers straight, internal ○ 180 mm	1032	T145	7 bits for slotted head screws ● 0,5x3 - 0,6x4,5 - 0,8x5,5 - 1x5,5 - 1,2x6,5 - 1,2x8 - 1,6x8 mm	861LP	T85
1 circlip pliers bent, internal ○ 170 mm	1034	T145	2 flat chisels, ribbed type 100 - 200 mm	35	T234
1 circlip pliers straight, external ● 175 mm	1036	T145	1 engineer's hammer 300 g	1370	T234
1 circlip pliers bent, external ● 175 mm	1038	T145	1 soft face hammer Ø 35 mm	1390	T234
1 Slip joint pliers boxed joints 240 mm	1048	T153	1 measuring tape 5 m	1692	T289
1 self - locking pliers 240 mm	1052	T153	1 mini hacksaw frame	1725CR	T289
1 heavy duty diagonal cutting nippers † 160 mm	1084BM	T131	1 plastic oil bottle	1755	T289
1 half-round needle nose pliers = 180 mm	1150BM	T131	1 snap - off blade utility knife	1771	T289
1 extra long needle knurled nose pliers, bi-material handles ● 160 mm	1166BM	T131	19 1/2" square drive hexagon sockets ○ 10 - 11 - 12+19 - 20 - 21 - 22 - 23 - 24 - 26 - 27 - 30 - 32 mm	920A	T80
1 reversible ratcheting wrench for bits 1/4x5/16	194	T85	5 1/2" drive, socket drivers for hexagon screws ○ 5 - 6 - 8 - 10 - 12 mm	920ME	T80
13 1/4" hexagon sockets ○ 4-4,5-5-5,5-6-7-8-9-10-11-12-13-14 mm	900	T85	1 1/2" drive extension bar 125 mm	920/21	T80
1 1/4" reversible ratchet ⊗ 125 mm	900/55	T85	1 1/2" drive extension bar 255 mm	920/22	T80
1 1/4" drive swivel T-handle 115 mm	900/42	T85	1 1/2" drive universal joint	920/25	T80
1 1/4" drive spinner handle 176 mm	900BG/30	T85	1 1/2" drive sliding T-handle	920/42	T80
1 1/4" drive universal joint 41 mm	900/25	T85	1 1/2" drive reversible ratchet ⊗	920/55	T80
1 1/4" drive extension bar 150 mm	900/21	T85	1 centre punch Ø 4 mm	32	T239
1 magnetic bit holder with handle 230 mm	851SR	T85	6 pin punches with handles 2-3-4-5-6-8 mm	31BM	T239
5 bits for Spanner screws ● 4-6-8-10-12 mm	861SP	T85	17 combination wrenches 6-7-8-10-11-12-13-14-16-17-18-19-21-22-24-27-30 mm	42	T10
8 bits for Torq-Set® head screws ● 0-1-2-3-4-5-6-8 mm	861TQS	T85	8 double open end wrenches 6x7 - 8x9 - 10x11 - 12x13 - 14x15 - 16x17 - 18x19 - 20x22 mm	55	T33
6 bits for Tri-Wing® head screws ● 1-2-3-4-5-6 mm	861TRW	T85	9 offset hexagon key wrenches ○	96/SC9	T33
8 bits for Tamper Resistant Torx® head screws ● T9-T10-T15-T20-T25-T27-T30-T40	861RTX	T85	6 T-handle wrenches with hexagon male ends ○ 2,5 - 3 - 4 - 5 - 6 - 8 mm	951	T68
11 bits for Torx® head screws ● T6-T7-T8-T9-T10-T15-T20-T25-T27-T30-T40	861TX	T85	5 second cut files 200 mm	1719BMA8/S5	T236
			11 offset hexagon key wrenches ○ 2 - 2,5 - 3 - 3,5 - 4 - 4,5 - 5 - 6 mm	96T	T50
			4 thermoformed trays, empty		VP-3SCVP-3SC
			4 thermoformed trays, empty		VP-LS VP-LS
			4 thermoformed trays, empty		VP-LD VP-LD

Universal use



Quantity/Description

6	pin punches 2 ÷ 8 mm
6	2 drift punches, 1 centre punch, 3 flat chisels with metal holder
17	combination wrenches 6÷22 - 24 - 27 - 30 - 32 mm
12	double open end wrenches 6x7 ÷ 30x32 mm
8	offset hexagon key wrenches 2 ÷ 10 mm
8	offset key wrenches, for Torx® head screws ⚙ T9 ÷ T40
1	adjustable wrench 250 mm
13	1/2" square drive hexagon sockets with rail ⌀ 10 ÷ 22 mm
8	1/2" square drive hexagon sockets with rail ⌀ 23 ÷ 32 mm
7	socket drivers for cross head Phillips® screws ⚙ 1,2x65 - 1,2x8 - 1,6x9 - 2x12mm - PH1-PH2-PH3
1	circlip pliers straight, internal ⌀ 180 mm
1	circlip pliers bent, internal ⌀ 170 mm
1	circlip pliers straight, external ⌀ 175 mm
1	circlip pliers bent, external ⌀ 175 mm
1	Slip joint pliers boxed joints 250 mm
1	self - locking pliers 240 mm
1	tin snips 250 mm
1	electrician's scissors, straight blades
8	2,5x50 - 3x75 - 4x100 - 5,5x125 - 6,5x150 - PH0 - PH1 - PH2
2	engineer's hammer 300 - 600 g
1	soft face hammer 35
1	measuring tape 5 m

Beta N.

31/SP6
38/SP6
42/S17X
55/S12X
96T/S8
97TX/SC8
111
920A/SB13
920A/SB8
920LH/SB7
1032
1034
1036
1038
1048
1052
1112
1128BMX
1263/D8
1370
1390
1692/5

Quantity/Description

1	flexible magnetic pick-up tool
1	two cutting edges scraper 200 mm
1	three - cutting edges scraper 200 mm
5	second cut files 200 mm
1	metal oil can 200 cc
1	snap - off blade utility knife
1	1/2" drive extension bar 125 mm
1	1/2" drive extension bar 250 mm
1	1/2" drive universal joint
1	1/2" drive sliding T-handle
1	1/2" drive reversible ratchet ⚙
1	pry bar
1	diagonal cutting nippers ⚡ 160 mm
1	heavy duty diagonal cutting nippers ⚡ 160 mm
1	toggle lever assisted end cutting nippers ⚡ 180 mm
1	half-round needle nose pliers = 180 mm
1	extra long needle knurled nose pliers, bi-material handles ● 160 mm
1	bent needle nose pliers ● 160 mm
2	screwdrivers for cross head Phillips® screws ● 8x200 - 10x200 mm
1	screwdrivers for cross head Phillips® screws ⚙ PH3 8x150mm
1	sliding gauge
1	hacksaw frame, aluminium handle 420 mm

Beta N.

1712E/2
1717A
1717B
1719BMA8/S5
1751
1771BM
920/21
920/22
920/25
920/42
920/55
963
1082BM
1084BM
1092V
1150BM
1166BM
1168BM
1260
1262
1650
1725

5957U-P

059570004

Assortment recommended in combination with C57S A - C57S B - C57SP

5958U

Assortment of 86 tools

Universal use

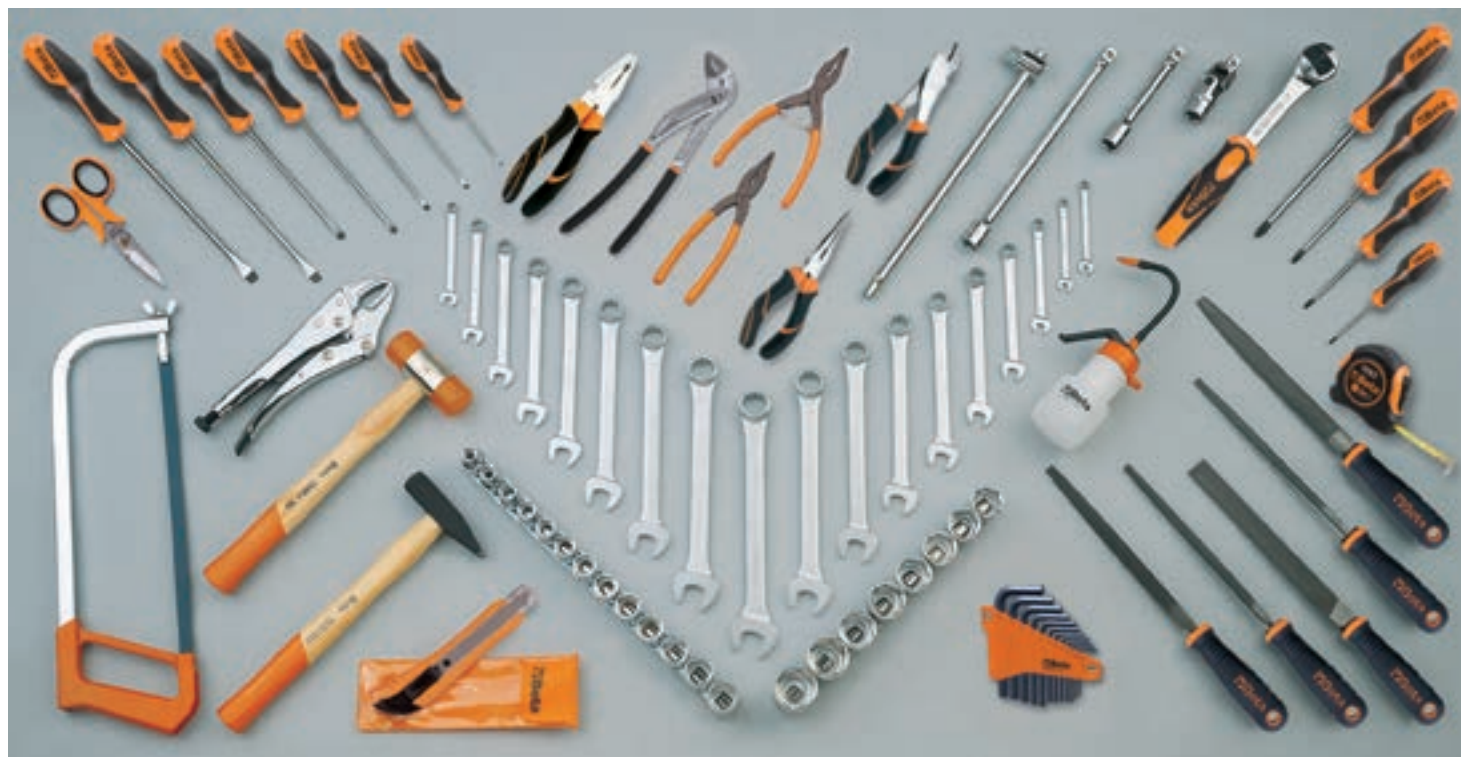

11.3 kg

Quantity/Description

- 17 combination wrenches 6÷22 mm
- 12 offset hexagon key wrenches \odot 2÷10 mm
- 13 1/2" square drive hexagon sockets with rail \odot 10÷22 mm
- 8 1/2" square drive hexagon sockets with rail \odot 23÷32 mm
- 1 1/2" drive extension bar 125 mm
- 1 1/2" drive extension bar 255 mm
- 1 1/2" drive universal joint
- 1 1/2" drive sliding T-handle
- 1 1/2" drive reversible ratchet \oplus
- 1 circlip pliers straight, internal \odot 180 mm
- 1 circlip pliers straight, external \bullet 175 mm
- 1 Slip joint pliers boxed joints 250 mm
- 1 self - locking pliers 240 mm
- 1 heavy duty diagonal cutting nippers \ddagger 160 mm
- 1 electrician's scissors, straight blades
- 1 half-round needle nose pliers \equiv 180 mm

Beta N.

- 42
- 96N/SC12
- 920A/SB13
- 920A/SB8
- 920/21
- 920/22
- 920/25
- 920/42
- 920/55
- 1032
- 1036
- 1048
- 1052
- 1084BM
- 1128BMX
- 1150BM

Quantity/Description

- 1 extra long needle knurled nose pliers, bi-material handles \bullet 160 mm
- 7 screwdrivers for cross head Phillips® screws \bullet 3x75 - 3,5x100 - 4x125 - 5,5x150 - 6,5x150 - 8x200 - 10x200 mm
- 4 screwdrivers for cross head Phillips® screws \oplus PH0x60 - PH1x80
- PH2x100 - PH3x150 mm
- 1 engineer's hammer 300 g
- 1 soft face hammer \varnothing 35 mm
- 1 measuring tape 5 m
- 5 200 mm
- 1 hacksaw frame, aluminium handle
- 1 plastic oil can 150 cc
- 1 snap - off blade utility knife

Beta N.

- 1166BM
- 1260
- 1262/S4
- 1370
- 1390
- 1692
- 1719BMA/S5
- 1725
- 1754
- 1771

5958U

059580008

Assortment recommended in combination with C58P

Bicycle repairs



Quantity/Description

Beta N.

Quantity/Description

Beta N.

9 combination wrenches 6-7-8-10-11-13-14-17-19 mm	42
9 ball head offset hexagon key wrenches \odot 1,5-2-2,5-3-4-5-6-8-10 mm	96BPC/SC9
8 offset hexagon key wrenches 2-2,5-3-4-5-6-8-10 mm	96T/S8
8 drivers for Torx® head screws, with handles \odot T8-T10-T15-T20-T25-T27-T30-T40	97TTX/S8
1 adjustable wrenches with scales chrome-plated 200 mm	111G
1 pipe cutter for copper and light alloy pipes	334
1 click-type torque wrenches with reversible ratchets 2+10 Nm	605E
13 \odot 4-4,5-5-5,5-6-7-8-9-10-11-12-13-14 mm	900/SB13
8 \odot 2,5-3-4-5-6-7-8-10 mm	900ME/SB8
8 \odot T9-T10-T15-T20-T25-T27-T30-T40	900TX/SB8
1 1/4" drive extension bar	900/21
1 1/4" drive universal joint	900/25

1 1/4" reversible ratchet \odot	900/55
1 Slip joint pliers boxed joints 250 mm	1048
1 diagonal cutting nippers ∇ 160 mm	1082
1 electrician's scissors, straight blades 145 mm	1128BM
1 half-round needle nose pliers \equiv 180 mm	1150
1 screwdrivers for slotted head screws \bullet 160 mm	1166
7 3x75-4x125-5,5x150-6,5x150-PH0x60-PH1x80-PH2x100 mm	1203/D7
1 engineer's hammer 300 g	1370
1 soft face hammer \emptyset 35 mm	1390
1 sliding gauge 150 mm	1650
1 measuring tape 3 m	1692
1 second cut files 200 mm	1719BMA8/P
1 second cut files 200 mm	1719BMA8/M
1 second cut files 200 mm	1719BMA8/R
1 hacksaw frame, aluminium handle 300 mm	1725
1 snap - off blade utility knife 18 mm	1771

5980U/BIKE

059800040

Assortment recommended in combination with C16 - CP17 - CP17L - C20L

Car repair

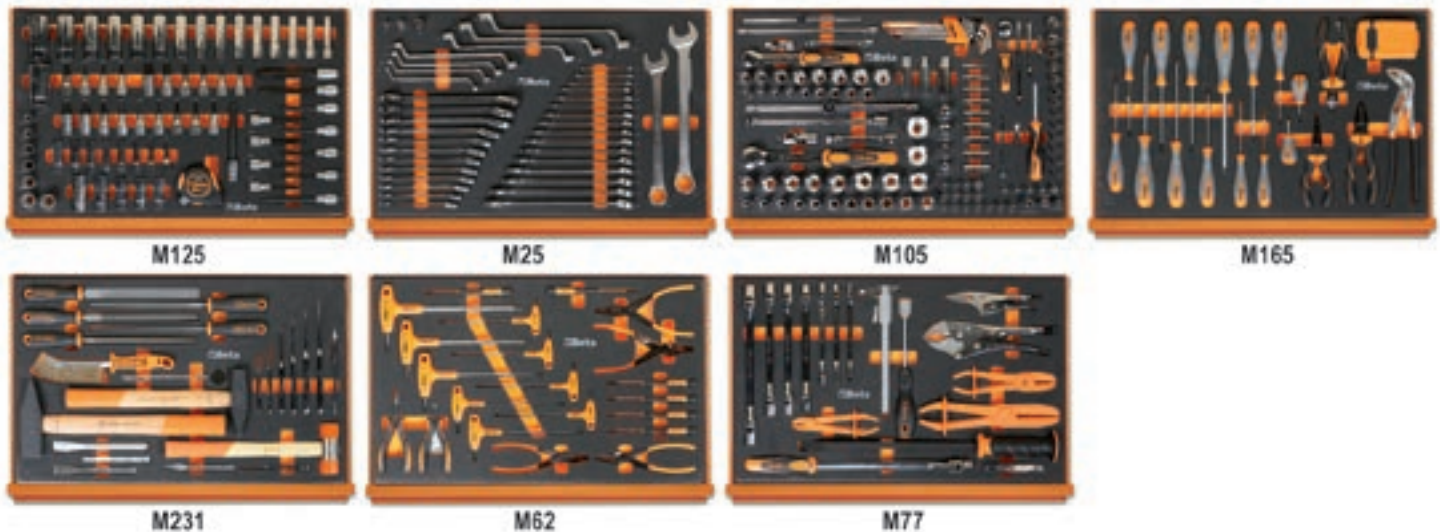

Quantity/Description	Beta N.	TR	Quantity/Description	Beta N.	TR
13 hexagon hand sockets ○ 8-9-10-11-12-13-14-15-16-17-19-21-22 mm	910AL	M125	1 Slip joint pliers boxed joints 250 mm	1048	M165
16 hexagon hand sockets ○ 10-12-13-14-15-16-17-18-19-21-22-23-24-27-30-32 mm	920AL	M125	1 diagonal cutting nippers † 160 mm	1082BM	M165
7 1/2" sockets for Torx® head screws ⊙ E12-E14-E16-E18-E20-E22-E24	920FTX	M125	1 half-round needle nose pliers ≡ 180 mm	1150BM	M165
10 socket drivers for hexagon screws ○ 5-6-6L-7-8-8L-10-10L-12-12L mm	920PE	M125	1 flat knurled nose pliers ≡ 160 mm	1162BM	M165
13 1/2" drive, socket drivers for Torx® head screws ⊙ T20-T25-T27-T30-T30L-T40-T40L-T45-T50-T50L-T55-T60-T60L	920TX	M125	5 screwdrivers for cross head Phillips® screws ● 3x75-4x100-5,5x100-6,5x150-8x150 mm	1290	M165
8 socket drivers with XZN® profile ○ 5-6-6L-8-8L-10-10L-12L mm	920XZN	M125	1 screwdriver for slotted head screws, extra-short series ● 6,5x30 mm	1290N	M165
18 combination wrenches 6-7-8-9-10-11-12-13-14-15-16-17-18-19-21-22-24-27 mm	42	M25	3 screwdrivers for cross head Phillips® screws ⊕ PH1-PH2-PH3	1292	M165
7 double ended offset ring wrenches 6x7-8x9-10x11-12x13-14x15-16x17-18x19 mm	90	M25	1 screwdriver for cross head Phillips® screws, extra-short series ⊕ PH2	1292N	M165
1 quick release adaptor, 1/4", for 10 mm ratcheting wrenches	123Q1/4	M25	4 drivers for Torx® head screws, with handles ○ T20-T25-T27-T30	1297TX	M165
1 quick release adaptor, 3/8", for 13 mm ratcheting wrenches	123Q3/8	M25	6 pin punches 2-3-4-5-6-8 mm	31	M231
1 quick release adaptor, 1/2", for 19 mm ratcheting wrenches	123Q1/2	M25	1 centre punch 4 mm	32	M231
12 reversible ratcheting combination wrenches 8-9-10-11-12-13-14-15-16-17-18-19 mm	142	M25	3 flat chisels 125-150-75 mm	34	M231
9 ball head offset hexagon key wrenches ○ 1,5-2-2,5-3-4-5-6-8-10 mm	96BPC/SC9	M105	1 cape chisels, standard type 125 mm	36	M231
1 socket holder ○1/4-□1/4	895/1	M105	2 engineer's hammer 500-1000 g	1370	M231
1 socket holder ○1/4-□3/8	895/3	M105	1 telescopic magnet with flexible head	1712TF	M231
1 socket holder ○5/16-□1/2	895/6	M105	1 soft face hammer Ø 35 mm	1390	M231
13 1/4" hexagon sockets ○ 4-4,5-5-5,5-6-7-8-9-10-11-12-13-14 mm	900	M105	1 measuring tape 5 m	1692	M125
9 hexagon hand sockets, long series ○ 5-6-7-8-9-10-11-12-13 mm	900L	M105	1 circlip pliers straight, internal ○ 180 mm	1032	M62
4 socket drivers for slotted head screws ● 0,8x4-1x5-1,2x6,5-1,2x8 mm	900LP	M105	1 circlip pliers bent, internal ○ 170 mm	1034	M62
5 1/4" socket drivers for hexagon screws ○ 3-4-5-6-7 mm	900ME	M105	1 circlip pliers straight, external ● 175 mm	1036	M62
4 socket drivers for cross head Phillips® screws ⊕ PH1-PH2-PH3-PH4	900PH	M105	1 circlip pliers bent, external ● 175 mm	1038	M62
7 socket drivers for Torx® head screws ○ T10-T15-T20-T25-T27-T30-T40	900TX	M105	1 smooth half - round long needle nose pliers ● 140 mm	1177BM	M62
1 adaptor, 1/4" female and 3/8" male drives □1/4-■3/8	900/16	M105	1 diagonal cutting nippers † 125 mm	1188BM	M62
3 1/4" drive extension bar 50-100-150 mm	900/...	M105	4 micro-screwdrivers for slotted head screws ● 2,0-2,5-3,0-3,5 mm	1257LP	M62
1 1/4" drive universal joint	900/25	M105	2 micro-screwdrivers for cross-head Phillips® screws ⊕ 0-00	1257PH	M62
1 1/4" drive swivel T-handle	900/42	M105	9 drivers for Torx® head screws, with handles ○ T10-T15-T20-T25-T27-T30-T40-T45-T50	97TTX	M62
1 1/4" reversible ratchet ⊕	900/55	M105	1 self - locking pliers 240 mm	1052	M77
1 1/4" drive spinner handle	900BG/30	M105	1 adjustable self locking pliers, long jaws 180 mm	1058	M77
17 hexagon hand sockets 3/8" ○ 6-7-8-9-10-11-12-13-14-15-16-17-18-19-20-21-22 mm	910A	M105	1 plastic hose pliers	1481PL/A	M77
1 adaptor, 3/8" female and 1/4" male drivers □3/8-■1/4	910/15	M105	1 plastic hose pliers	1481PL/B	M77
1 adaptor, 1/2" female and 3/8" male drives □3/8-■1/2	910/16	M105	1 plastic hose pliers	1481PL/C	M77
1 extension bar - 3/8" 125 mm	910/21	M105	1 sliding gauge	1650	M77
1 extension bar - 3/8" 250 mm	910/22	M105	1 metric feeler gauge	1708/20	M77
1 3/8" drive universal joint	910/25	M105	1 packing scraper	1716P	M77
1 3/8" drive sliding T - handle	910/42	M105	7 double swivel end socket wrenches 6x7-8x9-10x11-12x13-14x15-16x17-18x19 mm	80	M77
1 3/8" drive reversible ratchet ⊕	910/55	M105	1 1/2" drive swivel handle	920/36A	M77
21 1/2" square drive hexagon sockets ○ 8-10-11-12-13-14-15-16-17-18-19-20-21-22-23-24-26-27-28-30-32 mm	920A	M105	1 pry bar with handle 450 mm	965	M77
2 1/2" wobble extension bar 125-250 mm	920AN	M105	1 telescopic joint inspection mirror 670 mm	1715	M231
1 adaptor, 1/2" female and 3/8" male drives □1/2-■3/8	920/15	M105	1 second cut files 200 mm	1719BMA8/M	M231
1 1/2" drive universal joint	920/25	M105	1 second cut files 200 mm	1719BMA8/P	M231
1 1/2" drive sliding T-handle	920/42	M105	1 second cut files 200 mm	1719BMA8/Q	M231
1 1/2" drive reversible ratchet ⊕	920/55	M105	1 second cut files 200 mm	1719BMA8/R	M231
3 3/8" square drive spark plug sockets ○ 16-17-8-20,8 mm	956E	M105	1 second cut files 200 mm	1719BMA8/T	M231
31 bits with magnetic quick release bit holder in plastic case ● ○ ⊕ ⊕ ⊕ ⊕	860MIX/A31	M165	1 brake shoe cleaning brush plastic handle steel wires	1737NX	M231

Universal use



Quantity/Description

22	combination wrenches 6-7-8-9-10-11-12-13-14-15-16-17-18-19-20-21-22-24-27-30-32-36 mm
11	double open end wrenches 6x7-8x9-10x11-12x13-14x15-16x17-18x19-20x22-21x23-24x27-30x32 mm
11	double ended offset ring wrenches 6x7-8x9-10x11-12x13-14x15-16x17-18x19-20x22-21x23-24x27-30x32 mm
9	ball head offset hexagon key wrenches \odot 1,5-2-2,5-3-4-5-6-8-10 mm
6	screwdrivers for cross head Phillips® screws \bullet 2,5x50-3x75-4x100-5,5x125-6,5x150-8x200 mm
1	screwdrivers for slotted head screws, extra-short series \bullet 4x30 mm
4	screwdrivers for cross head Phillips® screws \oplus PH0x60-PH1x80-PH2x100-PH3x150 mm
1	screwdrivers for cross head Phillips® screws, extra-short series \oplus PH1x30 mm
12	drivers for Torx® head screws, with handles \odot T6-T7-T8-T9-T10-T15-T20-T25-T27-T30-T40-T45
1	main testing screwdriver \bullet
3	drift punches \varnothing 2-3-4 mm
6	pin punches \varnothing 2-3-4-5-6-8 mm
1	centre punch \varnothing 4 mm
1	flat chisels 150 mm
2	flat chisels, ribbed type 200-250 mm
1	cape chisels, standard type 125 mm
1	engineer's hammer 500 g
1	soft face hammer \varnothing 35 mm
1	measuring tape 3 m
1	telescopic magnet with flexible head
1	second-cut square files 200 mm
1	second-cut triangular files 200 mm
1	second-cut flat files 200 mm
1	second-cut half-round files 200 mm
1	second-cut round files 200 mm
1	brake shoe cleaning brush plastic handle steel wires
1	snap - off blade utility knife 18 mm
1	circlip pliers straight, internal \odot 180 mm
1	circlip pliers bent, internal \odot 170 mm
1	circlip pliers straight, external \bullet 175 mm
1	circlip pliers bent, external \bullet 175 mm
1	Slip joint pliers boxed joints 250 mm

Beta N.

TR

Quantity/Description

42	M10
55	M30
90	M30
96BPC/SC9	M30
1201	M210
1201N	M210
1202	M210
1202N	M210
1207TX	M210
1253	M210
30	M230
31	M230
32	M230
34	M230
35	M230
36	M230
1370	M230
1390	M230
1692	M230
1712TF	M230
1719BMA...Q	M230
1719BMA...T	M230
1719BMA...P	M230
1719BMA...M	M230
1719BMA...R	M230
1737NX	M230
1771	M230
1032	M130
1034	M130
1036	M130
1038	M130
1048	M130

Beta N.

TR

1	self - locking pliers 240 mm	1052	M130
1	diagonal cutting nippers ∇ 160 mm	1082BM	M130
1	construction worker's pincers 220 mm	1098	M130
1	tin snips 250 mm	1112	M130
1	electrician's scissors, straight blades	1128BM	M130
1	half-round needle nose pliers \equiv 180 mm	1150BM	M130
1	extra long needle knurled nose pliers, bi-material handles \bullet 160 mm	1166BM	M130
1	bent needle nose pliers \bullet 160 mm	1168BM	M130
1	socket holder	895/1	M100
1	socket holder	895/3	M100
1	socket holder	895/6	M100
13	1/4" hexagon sockets \odot 4-4,5-5-5,5-6-7-8-9-10-11-12-13-14 mm	900	M100
9	hexagon hand sockets, long series \odot 5-6-7-8-9-10-11-12-13 mm	900L	M100
5	1/4" socket drivers for hexagon screws \odot 3-4-5-6-7 mm	900ME	M100
4	socket drivers for slotted head screws \bullet 0,8x4-1x5,5-1,2x6,5-1,2x8 mm	900LP	M100
4	socket drivers for cross head Phillips® screws \oplus PH1-PH2-PH3-PH4	900PH	M100
7	socket drivers for Torx® head screws \odot T10-T15-T20-T25-T27-T30-T40	900TX	M100
1	1/4" drive extension bar 50 mm	900/20	M100
1	1/4" drive extension bar 100 mm	900/20L	M100
1	1/4" drive extension bar 150 mm	900/21	M100
1	1/4" drive universal joint	900/25	M100
1	1/4" drive spinner handle	900BG/30	M100
1	1/4" drive swivel T-handle	900/42	M100
1	1/4" reversible ratchet \odot	900/55	M100
21	1/2" square drive hexagon sockets \odot 8-10-11-12-13-14-15-16-17-18-19-20-21-22-23-24-26-27-28-30-32 mm	920A	M100
1	adaptor, 1/2" female and 3/8" male drives 125 mm	920/15	M100
1	1/2" drive universal joint 250 mm	920/25	M100
1	1/2" wobble extension bar	920AN/125	M100
1	1/2" wobble extension bar	920AN/250	M100
1	1/2" drive sliding T-handle	920/42	M100
1	1/2" drive reversible ratchet \odot	920/55	M100
8	1/2" sockets for Torx® head screws \odot 10-12-14-16-18-20-22-24 mm	920FTX	M100
11	hexagon hand sockets \odot 10-12-13-14-15-16-17-18-19-21-22 mm	920AL	M100

5935ET/1MB

assortment of 95 tools for tool chest C35, in soft foam trays

Electrotechnical maintenance



MB57



MB62

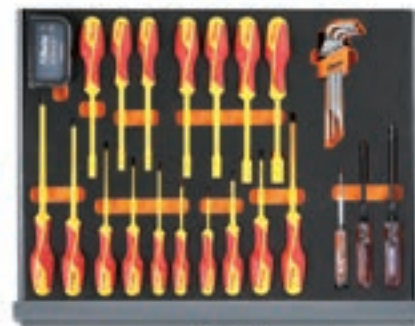

MB63

Quantity/Description

2	pin punches Ø 4-6 mm
1	centre punch Ø 4 mm
2	flat chisels, ribbed type 125-200 mm
1	engineer's hammer 300 g
1	soft face hammer Ø 35 mm
1	measuring tape 5 m
1	second-cut round files 200 mm
1	second-cut half-round files 200 mm
1	second-cut flat files 200 mm
1	second-cut triangular files 200 mm
1	second-cut square files 200 mm
1	hacksaw frame, aluminium handle 420 mm
1	flash light
8	double open end wrenches 6x7-8x9-10x11-12x13-14x15-16x17-18x19-20x22 mm
1	slip joint pliers, boxed joint 250 mm
1	diagonal cutting nippers 1000V ∇ 140 mm
1	electrician's scissors, straight blades, with countersink
1	cable cutter 230 mm
1	wire stripping pliers ∇ 160 mm
1	combination pliers 1000V \equiv 180 mm

Beta N.

TR

31	MB57
32	MB57
35	MB57
1370	MB57
1390	MB57
1692	MB57
1719BMA...R	MB57
1719BMA...M	MB57
1719BMA...P	MB57
1719BMA...T	MB57
1719BMA...Q	MB57
1725	MB57
1835	MB57
55	MB62
1048MQ	MB62
1082MQ	MB62
1128BSX	MB62
1132MQ	MB62
1142MQ	MB62
1150MQ	MB62

Quantity/Description

1	extra long needle nose pliers, 1000V, \bullet 160 mm	1166MQ	MB62
1	extra long bent needle nose pliers \bullet 160 mm	1168MQ	MB62
1	adjustable wrench, 1000V 250 mm	110MQ	MB62
1	utility knife, 1000V	1777MQ	MB62
1	bent knurled point spring tweezers, 1000V	993MQ	MB62
1	crimping pliers for insulated terminals	1602	MB62
9	ball head offset hexagon key wrenches \circ	96BPC/SC9	MB63
1	screwholding screwdriver for slotted head screws \bullet	1250	MB63
1	screwholding screwdriver for cross head Phillips® screws \oplus	1251	MB63
1	mains testing screwdriver \bullet	1253	MB63
6	hexagon nut spinners with handles \circ 5,5-6-7-8-10-13 mm	943MQ	MB63
4	screwdrivers for cross head Phillips® screws, 1000V \oplus PH0x60-PH1x80-PH2x100-PH3x150 mm	1272MQ	MB63
6	screwdrivers for headless slotted screws, 1000V \bullet 2,5x75-3x100-4x100-5,5x125-6x150-8x175 mm	1274MQ	MB63
31	bits with magnetic quick release bit holder in plastic case \bullet \circ \oplus \ominus \otimes	860MIX/A31	MB63
1	magnetic bit holder, insulated ®	850MQ	MB63

Beta N.

TR

5980ET/A

assortment of 69 tools

Electrotechnical maintenance



7.9 kg

Quantity/Description	Beta N.	Quantity/Description	Beta N.
1 centre punch Ø 4 mm	32	5 screwdrivers for cross head Phillips® screws ● 2,5x75 - 3,5x100 - 5,5x125 - 6,5x150 mm	1201
1 flat chisels, ribbed type 150 mm	35	1 screwdrivers for slotted head screws, extra-short series ● 4x30 mm	1201N
8 double open end wrenches 6x7 - 8x9 - 10x11 - 12x13 - 14x15 - 16x17 - 18x19 - 20x22 mm	55/B8	4 screwdrivers for cross head Phillips® screws ⊕ PH0x60 - PH1x120 - PH2x150 - PH3x150 mm	1202
8 offset hexagon key wrenches, long series ○ 1,5+12 mm	96LC/SC8	1 screwdrivers for cross head Phillips® screws, extra-short series ⊕ PH2x30 mm	1202N
1 adjustable wrench 200 mm	111	4 screwdrivers for cross head Phillips® screws, 1000V ⊕ PH0x60 - PH1x80 - PH2x100 - PH3x150 mm	1272MQ
1 magnetic bit holder, insulated ⊕	850MQ	5 screwdrivers for headless slotted screws, 1000V ● 5,5x125 - 3x100 - 4x100 - 6,5x150 - 8x175 mm	1274MQ
10 bits with magnetic bit holder in plastic case ● ⊕ ⊕	860MIX/A10	1 flat chisel with side cutter	1343
1 slip joint pliers, boxed joint 250 mm	1048MQ	1 engineer's hammer 300 g	1370
1 diagonal cutting nippers 160 mm	1082BM	1 soft face hammer Ø 35 mm	1390
1 electrician's scissors, straight blades, with countersink	1128BSX	1 crimping pliers for insulated terminals	1602
1 cable cutter 170 mm	1132BM	1 files 25 m	BME-SC
1 half-round needle nose pliers ≡ 180 mm	1150BM	1 measuring tape 5 m	1692
1 extra long needle knurled nose pliers, bi-material handles ● 160 mm	1166BM	1 files 200 mm	1719BMA/M
1 bent needle nose pliers ● 160 mm	1168BM	1 files 200 mm	1719BMA/R
1 screwholding screwdriver for slotted head screws ● 4x125 mm	1250	1 hacksaw frame, aluminium handle	1725
1 screwholding screwdriver	1251	1 fold - away knife	1777BM
1 for cross head Phillips® screws ⊕ PH1x150 mm			
1 mains testing screwdriver ●	1253		

5980ET/A

059800083

Assortment recommended in combination with C12 - 2032TV - 2032VV

5980ET/B

assortment of 64 tools

Electrotechnical maintenance



3.7 kg

Quantity/Description

Quantity/Description	Beta N.
3 pin punches Ø 2 - 3 - 4 mm	31
1 centre punch Ø 4 mm	32
1 flat chisels 150 mm	34
8 double open end wrenches 6x7 - 8x9 - 10x11 - 12x13 - 14x15 - 16x17 - 18x19 - 20x22 mm	55/B8
9 ball head offset hexagon key wrenches ○ 1,5 - 2 - 2,5 - 3 - 4 - 5 - 6 - 8 - 10 mm	96BPC/SC9
1 deburrer 150 mm	345SB
6 hexagon nut spinners with handles 1000V ○ 5,5 - 6 - 7 - 8 - 10 - 13 mm	943MQ/S6
1 slip joint pliers, boxed joint 250 mm	1048MQ
1 diagonal cutting nippers 1000V 160 mm	1082MQ
1 electrician's scissors, straight blades, with countersink	1128BSX
1 cable cutter 230 mm	1132MQ
1 wire stripping pliers 160 mm	1142MQ
1 combination pliers 1000V 180 mm	1150MQ
1 extra long needle nose pliers, 1000V, 160 mm	1166MQ
1 mains testing screwdriver	1253
3 screwdrivers for cross head Phillips® screws, 1000V PH0x60 - PH1x80 - PH2x100 mm	1272MQ
4 screwdrivers for headless slotted screws, 1000V 3x100 - 4x100 - 5,5x125 - 6,5x150 mm	1274MQ

Quantity/Description

Quantity/Description	Beta N.
1 engineer's hammer 300 g	1370
1 soft face hammer Ø 35 mm	1390
1 crimping pliers for insulated terminals	1602
1 flexible graduated rule 250 mm	1682
1 engineer's scriber 250 mm	1688
1 measuring tape 5 m	1692
1 spirit level, made of aluminium 200 mm	1696
1 electrician's chisel 10x200 mm	1701NE3
1 chalk line reel	1705
1 square flexible inspection mirror 600 mm	1715FL/A
1 second cut files 200 mm	1719BMA8/M
1 second cut files 200 mm	1719BMA8/R
1 spring puller	1723
1 hacksaw frame, aluminium handle	1726BM
1 bristle brush	1738
1 fitting tool for nylon ties	1743
1 plastic oil bottle 80 cc	1755
100 3,6x200 mm	1748N
100 4,8x300 mm	1748N
1 snap - off blade utility knife	1771BM
1 soldering iron 30 W	1814M
1 LED inspection torch	1835/2

5980 ET/B

059800084

Assortment recommended in combination with C12 - 2029/VV - 2033P/VV - 2036TV

5980MQ

assortment of 46 tools

Electrotechnical maintenance



7 kg

Quantity/Description

- 7 single open end wrenches, 1000V 10 - 12 - 13 - 14 - 17 - 19 - 22 mm
- 1 adjustable wrench, 1000V 250 mm
- 6 hexagon nut spinners with handles \varnothing 5,5 - 6 - 7 - 8 - 10 - 13 mm
- 4 T-handle wrenches with hexagon male ends \varnothing 4 - 5 - 6 - 8 mm
- 1 bent knurled point spring tweezers, 1000V
- 1 slip joint pliers, boxed joint 250 mm
- 1 diagonal cutting nippers 1000V \angle 160 mm
- 1 electrician's scissors
- 1 wire stripping pliers \angle 160 mm
- 1 combination pliers 1000V \equiv 180 mm
- 1 extra-long bent flat nose pliers \equiv 160 mm
- 1 extra long needle nose pliers, 1000V, \bullet 160 mm

Beta N.

- 52MQ
- 110MQ
- 943MQ
- 951MQ
- 993MQ
- 1048MQ
- 1082MQ
- 1128MQ
- 1142MQ
- 1150MQ
- 1164MQ
- 1166MQ

Quantity/Description

- 1 mains testing screwdriver \bullet
- 4 screwdrivers for cross head Phillips® screws, 1000V
 - \bullet PH0x60 - PH1x80 - PH2x100 - PH3x150 mm
- 5 screwdrivers for headless slotted screws, 1000V
 - \bullet 3x100 - 4x100 - 5,5x125 - 6,5x150 - 8x175 mm
- 1 engineer's hammer 300 g
- 1 soft face hammer \varnothing 35 mm
- 1 measuring tape 5 m
- 1 electrician's chisels 200 mm
- 1 mini - hacksaw frame, 1000V
- 2 utility knife, 1000V
- 1 soldering iron 30 W
- 1 high-brightness LED torch
- 1 combination voltage and continuity tester

Beta N.

- 1253
- 1272MQ
- 1274MQ
- 1370
- 1390
- 1692
- 1701NE/3
- 1725MQ
- 1777MQ
- 1814M
- 1834PS
- 1847P

5980MQ

059800257

Assortment recommended in combination with 2029/VV

5980EL/A

assortment of 57 tools

Electronics



Quantity/Description

- 13 small double open end wrenches 4÷14 mm
- 9 offset hexagon key wrenches \varnothing 1,5÷10 mm
- 1 bent point tweezers 130 mm
- 1 straight thin knurled point pin spring tweezers 150 mm
- 1 cross tweezers 155 mm
- 1 electrician's scissors, straight blades
- 1 wire stripping pliers \downarrow 160 mm
- 1 extra long needle knurled nose pliers, bi-material handles \bullet 160 mm
- 1 flat nose pliers \equiv
- 1 smooth half - round long bent needle nose pliers \bullet
- 1 combination pliers \bullet
- 1 diagonal flush cutting nippers ζ
- 1 diagonal cutting nippers ζ
- 1 screwholding screwdriver for slotted head screws \bullet 4x125 mm

Beta N.

- 73/B13
- 96N/SC9
- 991
- 992
- 998
- 1128BMX
- 1142BM
- 1166BM
- 1172BM
- 1178BM/P
- 1178BM
- 1185BM
- 1188BM
- 1250

Quantity/Description

- 1 screwholding screwdriver for cross head Phillips® screws \oplus PH0x125 mm
- 8 micro-screwdrivers
- 1 engineer's hammer 200 g
- 1 measuring tape 5 m
- 1 telescopic joint inspection mirror
- 3 needle files
- 1 spring puller
- 1 bristle brush
- 1 pen oiler
- 1 snap - off blade utility knife
- 1 self-locking round end knurled tool made of stainless steel
- 1 soldering iron 25 W
- 1 de - soldering pump
- 1 LED inspection torch

Beta N.

- 1251
- 1257LPH/S8
- 1370
- 1692
- 1715
- 1720/S3
- 1723
- 1738
- 1756
- 1771
- 1002
- 1814M
- 1830T
- 1835/2

5980EL/A

059800081

Assortment recommended in combination with 2032TV - 2028/VV - 2033P/VV

Electronics



Quantity/Description

- 13 small double open end wrenches 4÷14 mm
- 9 offset hexagon key wrenches 1,5÷10 mm
- 8 offset key wrenches for Torx® head screws T9 - T10 - T15 - T20 - T25 - T27 - T30 - T40
- 1 adjustable wrench 150 mm
- 18 set of 13 hexagon sockets and 5 accessories, 1/4" square drive
- 1 straight thin knurled point spring tweezers 130 mm
- 1 bent point tweezers 130 mm
- 1 extra slim short end spring tweezers 120 mm
- 1 electrician's scissors, straight blades
- 1 front wire stripping pliers, self - adjusting 170 mm
- 1 half-round needle nose pliers 180 mm
- 1 flat nose pliers 140 mm
- 1 smooth half - round long needle nose pliers 140 mm
- 1 smooth half - round long bent needle nose pliers 140 mm
- 1 diagonal flush cutting nippers, rounded tips 120 mm
- 1 diagonal flush cutting nippers, slim tips 120 mm
- 1 end flush oblique cutting nippers
- 8 micro-screwdrivers
- 1 mains testing screwdriver

Beta N.

- 73/B13
- 96/SC9
- 97TX/BG8
- 111
- 900/C13-5
- 990
- 991
- 999A
- 1128BMX
- 1149F
- 1150BM
- 1172BM
- 1177BM
- 1178BM/P
- 1184BM
- 1186BM
- 1191BM
- 1257LPH/S8
- 1253

Quantity/Description

- 1 screwdriver for slotted head screws, extra-short series 6,5x30 mm
- 3 screwdrivers for cross head Phillips® screws PH0x60 - PH1x80 - PH2x100 mm
- 2 screwdriver for cross head Phillips® screws, extra-short series PH1x30 - PH2x30 mm
- 5 screwdrivers for headless slotted screws 2,5x60 - 3x75 - 4x100 - 5x125 - 6,5x150 mm
- 1 engineer's hammer 200 g
- 1 flexible graduated rule 150 mm
- 1 engineer's scribe 220 mm
- 1 measuring tape 5 m
- 1 telescopic joint inspection mirror 670 mm
- 1 needle files
- 1 needle files
- 1 needle files
- 1 spring puller
- 1 bristle brush
- 1 pen oiler
- 1 snap - off blade utility knife
- 1 fold - away knife
- 1 self - locking tool
- 1 soldering iron 25W
- 1 de - soldering pump
- 1 LED inspection torch

Beta N.

- 1290N
- 1292
- 1292N
- 1294
- 1370
- 1682
- 1688
- 1692
- 1715
- 1720R
- 1720T
- 1720P
- 1723
- 1738
- 1756
- 1771BM
- 1777BM
- 1002
- 1814M
- 1830T
- 1835/2

5980EL/B

059800082

Assortment recommended in combination with 2029/VV - 2033P/VV - 2036TV

5980ID

Assortment of 35 tools

Plumbing maintenance



11.6 kg

Quantity/Description

- 1 flat chisels 150 mm
- 1 flat chisels, ribbed type 200 mm
- 12 double open end wrenches 6x7 - 8x9 - 10x11 - 12x13 - 14x15 - 16x17 - 18x19 - 20x22 - 21x23 - 24x27 - 25x28 - 30x32 mm
- 1 adjustable wrench 250 mm
- 1 pipe cutter for copper and light alloy pipes Ø 3÷30 mm
- 1 pipe wrench Swedish pattern 320 mm
- 1 Slip joint pliers boxed joints 250 mm
- 1 self - locking pliers 240 mm
- 1 tin snips 300 mm
- 1 electrician's scissors, straight blades
- 1 half-round needle nose pliers 180 mm

Beta N.

- 34
- 35
- 55/S12X
- 111
- 334
- 374
- 1048
- 1052
- 1112
- 1128BMX
- 1150BM

Quantity/Description

- 4 screwdrivers for cross head Phillips® screws ● 3x75 - 4x100 - 5,5x150 - 8x150 mm
- 2 screwdrivers for cross head Phillips® screws ⊕ PH1x80 - PH2x100 mm
- 1 engineer's hammer 300 g
- 1 measuring tape, made of fibre 2 m
- 1 measuring tape 5 m
- 1 spirit level, made of aluminium 200 mm
- 1 second-cut half-round files 200 mm
- 1 hacksaw frame, aluminium handle
- 1 brake shoe cleaning brush plastic handle steel wires

Beta N.

- 1201
- 1202
- 1370
- 1690F
- 1692
- 1696
- 1719BMA...M
- 1725
- 1737NX

5980 ID

059800085

Assortment recommended in combination with 2009N/VV

Car repairs



28.6 kg

Quantity/Description

- 2 drift punches Ø 3 - 4 mm
- 2 pin punches Ø 6 - 8 mm
- 1 centre punch Ø 4 mm
- 2 flat chisels, ribbed type 150 - 200 mm
- 18 combination wrenches 6+14 - 17 - 19 - 22
24 - 27 - 30 - 32 - 36 - 41 mm
- 10 double ended offset ring wrenches 6x7 - 8x9 - 10x11 - 12x13 - 14x15 -
16x17 - 18x19 - 20x22 - 24x27 - 30x32 mm
- 10 offset hexagon key wrenches \odot 1,5+12 mm
- 17 1/2" square drive hexagon sockets
 \odot 10+22 - 24 - 27 - 30 - 32 mm
- 1 1/2" drive extension bar 125 mm
- 1 1/2" drive extension bar 255 mm
- 1 1/2" drive universal joint
- 1 1/2" drive sliding T-handle
- 1 1/2" drive push-through square ratchet \otimes
- 11 3/4" square drive hexagon socket \odot 22 - 24 - 27 - 30 - 32 - 36 - 41 -
46 - 50 - 55 - 60 mm
- 1 3/4" drive extension bar 200 mm
- 1 3/4" drive swivel handle
- 1 3/4" drive sliding T - handle
- 1 3/4" drive reversible ratchet \otimes

- Beta N. 30
- 31
- 32
- 35
- 42
- 90
- 96N/B10
- 920A
- 920/21
- 920/22
- 920/25
- 920/42
- 920/50
- 928A
- 928/21
- 928/36A
- 928/42
- 928/55

Quantity/Description

- 1 pry bar 964
- 1 Slip joint pliers boxed joints 250 mm 1048
- 1 adjustable self locking pliers, curved jaws 1055
- 1 heavy duty diagonal cutting nippers \angle 160 mm 1084BM
- 1 electrician's scissors, straight blades 1128BMX
- 1 half-round needle nose pliers \equiv 180 mm 1150BM
- 1 extra long needle knurled nose pliers, bi-material handles \bullet 160 mm 1166BM
- 4 screwdrivers for slotted head screws with hexagon bolsters \bullet 1260E
6,5x150 - 8x175 - 10x200 - 12x250 mm
- 3 screwdrivers for cross head Phillips® screws with hexagon bolsters \oplus 1262E
PH2x150 - PH3x175 - PH4x200 mm
- 1 ball pein hammer 900 g 1377
- 1 soft face hammer Ø 35 mm 1390
- 1 metric feeler gauge 1708/20
- 1 three - cutting edges scraper 200 mm 1717B
- 5 second cut files 200 mm 1719BMA/S5
- 1 hacksaw frame, aluminium handle 1725

- Beta N. 964
- 1048
- 1055
- 1084BM
- 1128BMX
- 1150BM
- 1166BM
- 1260E
- 1262E
- 1377
- 1390
- 1708/20
- 1717B
- 1719BMA/S5
- 1725

5902MT

059020053

Assortment recommended in combination with C22S - C23S - C23SC - C39T

5902MT/AS

Assortment of 99 tools for earth-moving machinery (CATERPILLAR)

Car repairs



27.3 kg

Quantity/Description	Beta N.	Quantity/Description	Beta N.
2 drift punches Ø 3 - 4 mm	30	1 pry bar	964
2 pin punches Ø 6 - 8 mm	31	1 Slip joint pliers boxed joints 250 mm	1048
1 centre punch Ø 4 mm	32	1 adjustable self locking pliers, curved jaws	1055
2 flat chisels, ribbed type 150 - 200 mm	35	1 heavy duty diagonal cutting nippers 160 mm	1084BM
20 combination wrenches 1/4÷1.1/2"	42AS	1 electrician's scissors, straight blades	1128BMX
6 double ended offset ring wrenches 1/4x5/16 - 3/8x7/16 - 1/2x9/16	90AS	1 half-round needle nose pliers 180 mm	1150BM
5/8x3/4 - 11/16x13/16 - 7/8x15/16"		1 extra long needle knurled nose pliers, bi-material handles 160 mm	1166BM
11 offset hexagon key wrenches 3/64÷3/8"	96AS/B11	4 screwdrivers for slotted head screws with hexagon bolsters 6,5x150 - 8x175 - 10x200 - 12x250 mm	1260E
10 1/2" square drive bi - hex sockets 7/16 - 1/2 - 9/16	920AS	3 screwdrivers for cross head Phillips® screws with hexagon bolsters PH2x150 - PH3x175 - PH4x200 mm	1262E
5/8 - 11/16 - 3/4 - 13/16 - 7/8 - 15/16 - 1"		1 ball pein hammer 900 g	1377
1 1/2" drive extension bar 125 mm	920/21	1 soft face hammer Ø 35 mm	1390
1 1/2" drive extension bar 255 mm	920/22	1 metric feeler gauge 150 - 200 mm	1708/20
1 1/2" drive universal joint	920/25	1 three - cutting edges scraper 200 mm	1717B
1 1/2" drive sliding T-handle	920/42	5 second cut files 200 mm	1719BMA/S5
1 1/2" drive push-through square ratchet	920/50	1 hacksaw frame, aluminium handle	1725
12 hexagon hand sockets 1/4" 3/4", 7/8 - 15/16 - 1 - 1.1/16 - 1.1/8 - 1.1/4 - 1.5/16 1.1/2 - 1.5/8 - 1.11/16 - 1.7/8 - 2"	928AS		
1 3/4" drive extension bar 200 mm	928/21		
1 3/4" drive swivel handle	928/36A		
1 3/4" drive sliding T - handle	928/42		
1 3/4" drive reversible ratchet	928/55		

5902MT/AS

059020054

Assortment recommended in combination with C22S - C23S - C23SC - C39T

5904VG/1M

assortment of 76 tools

Car repair



Quantity/Description

Quantity/Description	Beta N.	TR
16 combination wrenches 6+21 mm	42	M15
5 combination wrenches 22 - 24 - 27 - 30 - 32 mm	42	M16
1 heavy duty diagonal cutting nippers 160 mm	1084	M132
1 half-round needle nose pliers 180 mm	1150	M132
1 screwdrivers for slotted head screws 160 mm	1166	M132
8 offset hexagon key wrenches 2-2,5-3-4-5-6-7-8 mm	96T	M50
5 drivers for Torx® head screws, with handles T10-T15-T20-T25-T30	97TTX	M55
4 screwdrivers for cross head Phillips® screws 3x75 - 4x100 - 5,5x150 - 6,5x150 mm	1201	M220
3 screwdrivers for cross head Phillips® screws PH0x60 - PH1x80 - PH2x100 mm	1202	M220
1 1/2" wobble extension bar 125 mm	920AN/125	M83
1 1/2" wobble extension bar 250 mm	920AN/250	M83

Quantity/Description

Quantity/Description	Beta N.	TR
1 1/2" drive universal joint	920/25	M83
1 1/2" drive sliding T-handle	920/42	M83
1 1/2" drive reversible ratchet	920/55	M83
19 1/2" square drive hexagon sockets	920A	M83
10+24 - 26 - 27 - 30 - 32 mm		
1 circlip pliers straight, internal 180 mm	1032	M145
1 circlip pliers bent, internal 170 mm	1034	M145
1 circlip pliers straight, external 175 mm	1036	M145
1 circlip pliers bent, external 175 mm	1038	M145
2 flat chisels, ribbed type 100 - 200 mm	35	M234
1 engineer's hammer 300 g	1370	M234
1 soft face hammer Ø 35 mm	1390	M234

5904 VG/1M

059040197

Assortment recommended in combination with C24S - C24SA - C37 - C39 with 5 - 6 - 7 - 8 drawers
C23ST - C39T - C24SL - C24SL/CAB - C59 - C55 - C28 - C39SM - C39MD

5904VG/2M

assortment of 170 tools

Car repair



M15 M16 VP/M3



M50 M55 M86



M208 M85 M234



M83 M131 M145

Quantity/Description

Quantity/Description	Beta N.	TR
16 combination wrenches 6÷21 mm	42	M15
5 combination wrenches 22 - 24 - 27 - 30 - 32 mm	42	M16
8 offset hexagon key wrenches \odot 2-2,5-3-4-5-6-7-8 mm	96T	M50
6 drivers for Torx® head screws, with handles \odot T10-T15-T20-T25-T27-T30	97TTX	M55
7 hexagon bits \odot 4-5-6-7-8-10-12 mm	867PE	M86
7 hexagon bits \odot 4-5-6-7-8-10-12 mm	867PE/L	M86
5 bits with XZN® profile \odot 5-6-8-10-12 mm	867XZN	M86
5 bits with XZN® profile \odot 5-6-8-10-12 mm	867XZN/L	M86
7 bits for Torx® head screws \odot T20-T25-T30-T40-T45-T50-T55	867TX	M86
6 bits for Torx® head screws \odot T25-T30-T40-T45-T50-T55	867TX/L	M86
7 bits for Tamper Resistant Torx® head screws \odot T20-T25-T30-T40-T45-T50-T55	867RTX	M86
1 bit holder sockets for item 867	867/1	M86
1 bit holder sockets for item 867	867/2	M86
5 screwdrivers for cross head Phillips® screws \bullet 3x75 - 4x100 - 4x125 - 5,5x150 - 6,5x150 mm	1260	M208
3 screwdrivers for cross head Phillips® screws \oplus PH0x60 - PH1x80 - PH2x100 mm	1262N	M208
1 screwdrivers for slotted head screws, extra-short series \bullet 4x30 mm	1260N	M208
1 screwdrivers for cross head Phillips® screws, extra - short series \oplus PH1x30 mm	1262N	M208
5 bits for slotted head screws, coloured \bullet 0,5x3 - 0,6x4,5 - 0,8x5,5 - 1x5,5 - 1,2x6,5 mm	860LP	M85
8 hexagon bits for power drivers, coloured \odot 2 - 2,5 - 3 - 4 - 5 - 6 - 8 - 10 mm	860PE	M85
5 bits for cross head Phillips® screws, coloured \oplus PH0 - PH1 - PH2 - PH3 - PH4	860PH	M85

Quantity/Description

Quantity/Description	Beta N.	TR
4 bits for cross head Pozidriv® - Supadriv® screws, coloured \oplus PZ1 - PZ2 - PZ3 - PZ4	860PZ	M85
10 bits for Torx® head screws, coloured \odot T7-T8-T9-T10-T15-T20-T25-T27-T30-T40	860TX	M85
8 bits for Tamper Resistant Torx® head screws, coloured \odot T9-T10-T15-T20-T25-T27-T30-T40	860RTX	M85
1 magnetic bit holder with handle 230 mm	851SR	M85
1 reversible bit ratchet 100 mm	860/55	M85
2 flat chisels, ribbed type 100 - 200 mm	35	M234
1 engineer's hammer 300 g	1370	M234
1 soft face hammer \varnothing 35 mm	1390	M234
1 1/2" wobble extension bar 125 mm	920AN/125	M83
1 1/2" wobble extension bar 250 mm	920AN/250	M83
1 1/2" drive universal joint	920/25	M83
1 1/2" drive sliding T-handle	920/42	M83
1 1/2" drive reversible ratchet \oplus	920/55	M83
19 1/2" square drive hexagon sockets \odot 10÷24 - 26 - 27 - 30 - 32 mm	920A	M83
1 half-round needle nose pliers \equiv 180 mm	1150BM	M131
1 extra long needle knurled nose pliers, bi-material handles \bullet 160 mm	1166BM	M131
1 heavy duty diagonal cutting nippers ∇ 160 mm	1084BM	M131
1 circlip pliers straight, internal \odot 180 mm	1032	M145
1 circlip pliers bent, internal \odot 170 mm	1034	M145
1 circlip pliers straight, external \bullet 175 mm	1036	M145
1 circlip pliers bent, external \bullet 175 mm	1038	M145
1	VPM3	

5904VG/2M

059040198

Assortment recommended in combination with C24S - C24SA - C37 - C39 C24SL - C24SL/CAB - C59 - C55 - C39T - C39SM - C39MD - C23ST - C28

5904VG/2T

Assortment of 99 tools

Car repairs



T15 T16 T80



T153 T132 T145 T234



T208 T33 T52 T55

14.5 kg

Quantity/Description

- 16 combination wrenches 6÷21 mm
- 5 combination wrenches 22 - 24 - 27 - 30 - 32 mm
- 19 1/2" square drive hexagon sockets
○ 10÷24 - 26 - 27 - 30 - 32 mm
- 5 1/2" drive, socket drivers for hexagon screws
○ 5 - 6 - 8 - 10 - 12 mm
- 1 1/2" drive extension bar 125 mm
- 1 1/2" drive extension bar 255 mm
- 1 1/2" drive universal joint
- 1 1/2" drive sliding T-handle
- 1 1/2" drive reversible ratchet ☉
- 1 Slip joint pliers boxed joints 250 mm
- 1 self - locking pliers 240 mm
- 1 heavy duty diagonal cutting nippers ✂ 160 mm
- 1 screwdrivers for slotted head screws ● 160 mm
- 1 half-round needle nose pliers ≡ 180 mm
- 1 circlip pliers straight, internal ○ 180 mm
- 1 circlip pliers straight, external ● 175 mm

Beta N.	TR
42	T15
42	T16
920A	T80
920ME	T80
920/21	T80
920/22	T80
920/25	T80
920/42	T80
920/55	T80
1048	T153
1052	T153
1084	T132
1166	T132
1150	T132
1032	T145
1036	T145

Quantity/Description

- 1 circlip pliers bent, internal ○ 170 mm
- 1 circlip pliers bent, external ● 175 mm
- 2 flat chisels, ribbed type 100 - 200 mm
- 1 engineer's hammer 300 g
- 1 soft face hammer Ø 35 mm
- 4 screwdrivers for cross head Phillips® screws
● 3x75 - 4x100 - 5,5x150 - 6,5x150 mm
- 3 screwdrivers for cross head Phillips® screws
⊕ PH0x60 - PH1x80 - PH2x100 mm
- 8 double open end wrenches 6x7 - 8x9 - 10x11 - 12x13 - 14x15
- 16x17 - 18x19 - 20x22 mm
- 9 offset hexagon key wrenches
○ 1,5 - 2 - 2,5 - 3 - 4 - 5 - 6 - 8 - 10 mm
- 6 offset hexagon key wrenches ○ 2 - 2,5 - 3 - 4 - 5 - 6 mm
- 6 drivers for Torx® head screws, with handles ○ T10 - T15 - T20
- T25 - T27 - T30

Beta N.	TR
1034	T145
1038	T145
35	T234
1370	T234
1390	T234
1260	T208
1262	T208
55	T33
96/SC9	T33
96T	T52
97TTX	T55

5904 VG/2T

059040191

Assortment recommended in combination with C24S - C24SA - C37 - C39
C23ST - C39T - C24SL - C24SL/CAB - C59 - C55 - C28 - C39SM - C39MD

5904VG/3

Assortment of 132 tools

Car repairs



20.7 kg

Quantity/Description

6	pin punches Ø 2+8 mm
1	centre punch Ø 5 mm
1	flat chisels, ribbed type 200 mm
17	combination wrenches 6+22 mm
8	double open end wrenches 6x7 - 8x9 - 10x11 - 12x13 - 14x15 - 16x17 - 18x19 - 20x22 mm
9	offset hexagon key wrenches Ø 1,5 - 2 - 2,5 - 3 - 4 - 5 - 6 - 8 - 10 mm
11	offset hexagon key wrenches Ø 2+10 mm
13	offset key wrenches for Tonx® head screws T6+T50
1	adjustable wrench 300 mm
13	1/2" square drive hexagon sockets with rail Ø 10+22 mm
1	1/2" drive extension bar 125 mm
1	1/2" drive extension bar 255 mm
1	1/2" drive universal joint
1	1/2" drive sliding T-handle
1	1/2" drive push-through square ratchet @
6	T - handle wrenches with swivelling socket Ø 8 - 10 - 12 - 13 - 17 - 19 mm
1	pry bar with handle 450 mm
2	circclip pliers straight, internal Ø 180 - 225 mm
2	circclip pliers bent, internal Ø 170 - 210 mm
2	circclip pliers straight, external ● 175 - 225 mm
2	circclip pliers bent, external ● 175 - 220 mm
1	Slip joint pliers boxed joints 250 mm
1	self - locking pliers 240 mm
1	heavy duty diagonal cutting nippers † 200 mm
1	toggle lever assisted end cutting nippers † 200 mm

Beta N.

31/B6
32
35
42
55
96N/SC9
96T/SP11
97TX/B13
111
920A/SB13
920/21
920/22
920/25
920/42
920/50
952
965
1032
1034
1036
1038
1048
1057A
1084BM
1092V

Quantity/Description

1	tin snips 250 mm
1	electrician's scissors, straight blades
1	half-round needle nose pliers = 180 mm
4	screwdrivers for cross head Phillips® screws ● 3x75 - 4x100 - 5,5x125 - 6,5x150 mm
1	screwdrivers for slotted head screws, extra-short series ● 6,5x30 mm
2	screwdrivers for slotted head screws with hexagon bolsters ● 8x175 - 10x200 mm
3	screwdrivers for cross head Phillips® screws ● PH0x100 - PH1x120 - PH2x100 mm
1	screwdrivers for cross head Phillips® screws, extra - short series ● PH2x30 mm
1	screwdrivers for cross head Phillips® screws with hexagon bolsters ● PH3x175mm
1	screwdriver for cross head Phillips® screws, long series ● PH2x400 mm
1	screwdriver for headless slotted screws, long series ● 6,5x400 mm
1	engineer's hammer 500 g
1	soft face hammer Ø 45 mm
1	adjustable oil filter wrench
1	metric feeler gauge
5	200 mm
1	hacksaw frame, aluminium handle
1	metal oil can 200 cc

Beta N.

1112
1128BMX
1150BM
1260
1260N
1260E
1262
1262N
1262E
1262L
1264L
1370
1390
1491
1708/20
1719BMA/S5
1726BM
1751

5904 VG/3

059040062

Assortment recommended in combination with C24S - C24SA - C37 - C39 with 7 - 8 drawers
C24SL - C24SL/CAB - C59 - C55

5904VG/3T

assortment of 102 tools in foam trays

Car repair



T199 T202 T83



T145 T153 T131 T234



T52 T33 T15 T16



T63 VP5

Quantity/Description

- 21 combination wrenches 6-7-8-9-10-11-12-13-14-15-16-17-18-19-20-21-22-24-27-30-32 mm
- 8 double open end wrenches 6x7-8x9-10x11-12x13-14x15-16x17-18x19-20x22 mm
- 9 offset hexagon key wrenches \odot 1,5+10 mm
- 6 offset hexagon key wrenches \odot 2-2,5-3-4-5-6 mm
- 8 T - handle wrenches with swivelling socket \odot 7-8-10-12-13-14-17-19 mm
- 19 1/2" square drive hexagon sockets \odot 10-11-12-13-14-15-16-17-18-19-20-21-22-23-24-26-27-30-32 mm
- 1 1/2" drive extension bar 125 mm
- 1 1/2" drive extension bar 255 mm
- 1 1/2" drive universal joint
- 1 1/2" drive sliding T-handle 305 mm
- 1 1/2" drive reversible ratchet \otimes
- 1 heavy duty diagonal cutting nippers ∇ 160 mm
- 1 half-round needle nose pliers \equiv 180 mm
- 1 extra long needle knurled nose pliers, bi-material handles \bullet 160 mm
- 1 circlip pliers straight, internal \odot 180 mm

Beta N.	TR
42	T15-T16
55	T33
96/SC9	T33
96T	T52
952	T63
920A	T83
920/21	T83
920/22	T83
920/25	T83
920/42	T83
920/55	T83
1084BM	T131
1150BM	T131
1166BM	T131
1032	T145

Quantity/Description

- 1 circlip pliers bent, internal \odot 170 mm
- 1 circlip pliers straight, external \bullet 175 mm
- 1 circlip pliers bent, external \bullet 175 mm
- 1 self - locking pliers 240 mm
- 1 Slip joint pliers boxed joints 250 mm
- 7 screwdrivers for cross head Phillips[®] screws \bullet 2,5x50 -3x75 -3,5x100-4x125 -5,5x100 - 5,5x150-6,5x150 mm
- 6 screwdrivers for cross head Phillips[®] screws \oplus PH0x60 - PH0x100 - PH1x80-PH1x120 - PH2x100 - PH2x150 mm
- 2 flat chisels, ribbed type 100-200 mm
- 1 engineer's hammer 300 g
- 1 soft face hammer \varnothing 35 mm
- 1 empty thermoformed tray

Beta N.	TR
1034	T145
1036	T145
1038	T145
1052	T153
1048	T153
1260	T199
1262	T202
35	T234
1370	T234
1390	T234
VP5	

5904 VG/3T

059040510

Assortment recommended in combination with C24S - C24SA - C37 - C39 C24SL - C24SL/CAB - C59 - C55 - C23ST - C39T - C28 - C39SM - C39MD

5904VG/5T

Assortment of 153 tools

Car repairs



T80 T15 T16



T63 VP6



T145 T170 T176 T52



T33 T171 T172 T173



T234 T131 T112 T153

25 kg

Quantity/Description

- 5 1/2" drive, socket drivers for hexagon screws
○ 5 - 6 - 8 - 10 - 12 mm
- 1 1/2" drive extension bar 125 mm
- 1 1/2" drive extension bar 255 mm
- 1 1/2" drive universal joint
- 1 1/2" drive sliding T-handle
- 1 1/2" drive reversible ratchet
- 19 1/2" square drive hexagon sockets
○ 10÷24 - 26 - 27 - 30 - 32 mm
- 16 combination wrenches 6÷21 mm
- 5 combination wrenches 22 - 24 - 27 - 30 - 32 mm
- 8 T - handle wrenches with swivelling socket ○ 7 - 8 - 10 - 12 - 13 - 14 - 17 - 19 mm
- empty thermoformed tray
- 1 circlip pliers straight, internal ○ 180 mm
- 1 circlip pliers bent, internal ○ 170 mm
- 1 circlip pliers straight, external ● 175 mm
- 1 circlip pliers bent, external ● 175 mm
- 7 screwdrivers for cross head Phillips® screws ● 2,5x50 - 3x75 - 3,5x100 - 4x125 - 5,5x100 - 5,5x150 - 6,5x150 mm
- 5 drivers for Torx® head screws, with handles
○ T25 - T27 - T30 - T40 - T45
- 6 offset hexagon key wrenches ○ 2 - 2,5 - 3 - 4 - 5 - 6 mm
- 8 double open end wrenches 6x7 - 8x9 - 10x11 - 12x13 - 14x15 - 16x17-18x19 - 20x22 mm
- 9 offset hexagon key wrenches
○ 1,5 - 2 - 2,5 - 3 - 4 - 5 - 6 - 8 - 10 mm
- 3 screwdrivers for cross head Phillips® screws
● 8x150 - 8x200 - 10x200 mm

Beta N.	TR
920ME	T80
920/21	T80
920/22	T80
920/25	T80
920/42	T80
920/55	T80
920A	T80
42	T15
42	T16
952	T63
VP6	VP6
1032	T145
1034	T145
1036	T145
1038	T145
1290	T170
1297TX	T176
96T	T52
55	T33
96N/SC9	T33
1290	T171

Quantity/Description

- 2 screwdriver for slotted head screws, extra-short series ● 4x30 - 6,5x30 mm
- 6 screwdrivers for cross head Phillips® screws ● PH0x60 - PH0x100 - PH1x80 - PH1x120 - PH2x100 - PH2x150 mm
- 2 screwdrivers for cross head Phillips® screws ● PH3x150 - PH4x200 mm
- 2 screwdriver for cross head Phillips® screws, extra-short series ● PH1x30 - PH2x30 mm
- 2 flat chisels, ribbed type 100 - 200 mm
- 1 engineer's hammer 300 g
- 1 soft face hammer Ø 35 mm
- 1 half-round needle nose pliers = 180 mm
- 1 extra long needle knurled nose pliers, bi-material handles ● 160 mm
- 1 heavy duty diagonal cutting nippers ✂ 160 mm
- 6 bits for Torx® head screws ○ T6÷T15
- 8 bits for Torx® head screws ○ T20÷T55
- 1 socket holder
- 1 socket holder
- 6 1/4" sockets for Torx® head screws ○ E4÷E10
- 7 1/2" sockets for Torx® head screws ○ E12÷E24
- 3 1/2" drive, socket drivers for Torx® head screws
○ T55L - T60 - T70L
- 1 Slip joint pliers boxed joints 250 mm
- 1 self - locking pliers 240 mm
- 1 empty thermoformed tray

Beta N.	TR
1290N	T171
1292	T172
1292	T173
1292N	T173
35	T234
1370	T234
1390	T234
1150BM	T131
1166BM	T131
1084BM	T131
861TX	T112
866TX	T112
895/1	T112
895/6	T112
900FTX	T112
920FTX	T112
920TX	T112
1048	T153
1052	T153
VP6	VP6

5904 VG/5T

059040196

Assortment recommended in combination with C24S with 7 - 8 drawers - C24SA with 7 - 8 drawers - C37 with 7 - 8 drawers - C39 with 7 - 8 drawers - C24SL - C24SL/CAB - C59 - C55 - C23ST - C28 - C39MD - C39SM

Car repairs



20 kg

Quantity/Description

1	drift punches Ø 4 mm
6	pin punches Ø 2 - 3 - 4 - 5 - 6 - 8 mm
1	centre punch Ø 4 mm
1	flat chisels 150 mm
1	cape chisels, standard type 150 mm
17	combination wrenches 6÷22 mm
10	offset hexagon key wrenches ○ 1,5÷12 mm
1	adjustable wrench 300 mm
12	hi-torque hexagon nut spinners, long series ○ 4÷14 mm
1	pry bar with handle 450 mm
1	Slip joint pliers boxed joints 250 mm
1	self - locking pliers 240 mm
1	adjustable self locking pliers, aluminium jaws 280 mm
1	heavy duty diagonal cutting nippers < 160 mm
1	construction worker's pincers 250 mm
1	compound leverage shears, straight blades
1	electrician's scissors, straight blades
1	half-round needle nose pliers = 180 mm
1	screwdriver for Dzus® head screws ●
4	screwdrivers for cross head Phillips® screws ● 3x75 - 4x100 - 5,5x150 - 6,5x150 mm
1	screwdrivers for slotted head screws, extra-short series ● 4x30 mm
2	screwdrivers for slotted head screws with hexagon bolsters ● 10x175 - 12x200 mm

Beta N.

30
31/B6
32
34
36
42/S17
96/B10
111N
943BX
965
1048
1052
1060AL
1084BM
1098PL
1122
1128BMX
1150BM
1201DZ
1260
1260N
1260E

Quantity/Description

3	screwdrivers for cross head Phillips® screws ➤ PH0x60 - PH1x80 - PH2x100 mm
1	screwdrivers for cross head Phillips® screws, extra - short series ➤ PH1x30 mm
1	screwdrivers for cross head Phillips® screws with hexagon bolsters ➤ PH3x175 mm
7	drivers for Torx® head screws ○ T6 - T8 - T10 - T15 - T20 - T25 - T30
1	curved dolly 1350 g
1	toe dolly
1	heel dolly
1	general purpose dolly
1	buffer dolly
1	curved angle spoon
1	heavy duty spoon
1	long double-ended spoon
1	body blade holder, with blade 9"
1	extra flat chisel with hand guard
1	body hammer
1	body hammer Ø 32 mm
1	engineer's hammer 300 g
1	soft face hammer Ø 35 mm
1	measuring tape 5 m

Beta N.

1262
1262N
1262E
1267TX
1303
1305
1306
1310
1313
1326
1327
1330
1338A
1342PM
1345
1357Z/32
1370
1390
1692

5905VG/1

059050058

Assortment recommended in combination with C25

Car repairs



19.5 kg

Quantity/Description

- 6 2 drift punches, 1 centre punch, 3 flat chisels with metal holder
- 13 combination wrenches 6+14 - 17 - 19 - 22 - 24 mm
- 13 double open end wrenches 6x7 - 8x9 - 10x11 - 12x13 - 14x15 - 16x17 - 18x19 - 20x22 - 21x23 - 24x26 - 25x28 - 27x29 - 30x32 mm
- 3 half - moon ring wrenches 11x13 - 14x17 - 19x22 mm
- 10 offset hexagon key wrenches 1,5+12 mm
- 6 drivers for Torx® head screws, with handles
 ○ T10 - T15 - T20 - T25 - T30 - T40
- 2 1/2" drive impact sockets ○ 17 - 19 mm
- 20 1/2" square drive hexagon sockets ○ 10+24 - 26 - 27 - 28 - 30 - 32 mm
- 1 1/2" drive extension bar 125 mm
- 1 1/2" drive extension bar 255 mm
- 1 1/2" drive universal joint
- 1 1/2" drive sliding T-handle
- 1 1/2" drive reversible ratchet ⊕
- 8 T - handle wrenches with swivelling socket
 ○ 7 - 8 - 10 - 11 - 13 - 14 - 17 - 19 mm
- 1 T - handle swivel spark plug wrenches
- 1 wheel nut wrench ○ 17x19x22x ■ 1/2"
- 1 circlip pliers straight, internal ○ 180 mm
- 1 circlip pliers bent, internal ○ 170 mm
- 1 circlip pliers straight, external ● 175 mm
- 1 circlip pliers bent, external ● 175 mm

Beta N.

- 38/B6
- 42
- 55
- 83
- 96N/B10
- 97TTX
- 720
- 920A
- 920/21
- 920/22
- 920/25
- 920/42
- 920/55
- 952
- 959
- 979
- 1032
- 1034
- 1036
- 1038

Quantity/Description

- 1 Slip joint pliers boxed joints 250 mm
- 1 self - locking pliers 240 mm
- 1 heavy duty diagonal cutting nippers < 160 mm
- 1 compound leverage shears, straight blades 250 mm
- 1 electrician's scissors, straight blades
- 1 half-round needle nose pliers = 180 mm
- 1 extra long needle knurled nose pliers, bi-material handles ● 160 mm
- 8 screwdrivers for cross head Phillips® screws ● 2,5x50 - 3x75 - 3,5x100 - 4x125 - 5,5x125 - 6,5x150 - 8x200 - 10x200 mm
- 2 screwdrivers for slotted head screws with hexagon bolsters
 ● 10x200 - 12x250 mm
- 1 screwdrivers for slotted head screws, extra-short series ● 6,5x30 mm
- 4 screwdrivers for cross head Phillips® screws ⊕ PH0x60 - PH1x80 - PH2x100 - PH3x150 mm
- 1 engineer's hammer 400 g
- 1 soft face hammer Ø 35 mm
- 1 adjustable oil filter wrench
- 1 circuit tester 3÷48 V

Beta N.

- 1048
- 1052
- 1084BM
- 1122
- 1128BMX
- 1150BM
- 1166BM
- 1260
- 1260E
- 1260N
- 1262
- 1370
- 1390
- 1491
- 1498

5905 VG/2 059050044

Assortment recommended in combination with C25

Car repair



Quantity/Description

16	combination wrenches 6+21 mm	42	T15
5	combination wrenches 22 - 24 - 27 - 30 - 32 mm	42	T16
5	pin punches Ø 2 - 3 - 4 - 5 - 6 mm	31	T31
1	centre punch Ø 4 mm	32	T31
12	double open end wrenches 6x7 - 8x9 - 10x11 - 12x13 - 14x15 - 16x17 - 18x19 - 20x22 - 21x23 - 24x26 - 27x29 - 30x32 mm	55	T31
9	offset hexagon key wrenches Ø 1,5 - 2 - 2,5 - 3 - 4 - 5 - 6 - 8 - 10 mm	96N/SC9	T31
5	1/2" drive, socket drivers for hexagon screws Ø 5 - 6 - 8 - 10 - 12 mm	920ME	T80
1	1/2" drive extension bar 125 mm	920/21	T80
1	1/2" drive extension bar 255 mm	920/22	T80
1	1/2" drive universal joint	920/25	T80
1	1/2" drive sliding T-handle	920/42	T80
1	1/2" drive reversible ratchet Ⓞ	920/55	T80
19	1/2" square drive hexagon sockets Ø 10+24 - 26 - 27 - 30 - 32 mm	920A	T80
1	circlip pliers straight, internal Ø 180 mm	1032	T145
1	circlip pliers bent, internal Ø 170 mm	1034	T145
1	circlip pliers straight, external ● 175 mm	1036	T145
1	circlip pliers bent, external ● 175 mm	1038	T145
1	circlip pliers straight, internal Ø 140 mm	1032	T146
1	circlip pliers straight, internal Ø 225 mm	1032	T146
1	circlip pliers straight, external ● 140 mm	1036	T146
1	circlip pliers straight, external ● 225 mm	1036	T146
9	screwdrivers for cross head Phillips® screws ● 3x75 - 3x100 - 4x100 - 4x150 - 5,5x100 - 5,5x150 - 6,5x150 - 8x150 - 10x200 mm	1260	T167
2	screwdrivers for slotted head screws, extra-short series ● 4x30 - 6,5x30 mm	1260N	T167
7	screwdrivers for cross head Phillips® screws ● PH0x60 - PH0x100 - PH1x80 - PH1x120 - PH2x100 - PH2x150 - PH3x150 mm	1262	T168
2	screwdrivers for cross head Phillips® screws, extra - short series ● PH1x30 - PH2x30 mm	1262N	T168
8	T - handle wrenches with swivelling socket Ø 7 - 8 - 10 - 12 - 13 - 14 - 17 - 19 mm	952	T63
2	screwdriver for cross head Phillips® screws, long series ● PH1x400 - PH2x400 mm	1262L	T209
3	screwdriver for headless slotted screws, long series ● 3x300 - 4x400 - 5x400 mm	1264L	T209
6	drivers for Torx® head screws, with handles Ø T10-T15-T20-T25-T27-T30	97TTX	T55
13	1/2" drive impact sockets Ø 10-11-12-13-14-16-17-18-19-21-22-23-24 mm	720	T110
1	1/2" drive impact extension bar 125 mm	720/21	T110
5	socket drivers for hexagon screws Ø 5L - 6L - 7L - 8L - 10L	920PE	T113

Beta N. TR

Quantity/Description

4	1/2" drive, socket drivers for Torx® head screws Ø T40L - T45L - T55L - T70L	920TX	T113
3	socket drivers with XZN® profile Ø M6L - M8L - M12L	920XZN	T113
5	second cut files 200 mm	1719BMA8/S5	T236
1	adjustable oil filter wrench 110 mm	1491	T264
1	square oil drain plug socket ■ 10 mm	1494	T264
7	male hexagon oil drain plug sockets Ø 8-9-10-11-12-14-17 mm	1494E	T264
4	male square oil drain plug sockets Ø 8-9,5-12-13 mm	1494Q	T264
1	male triangular oil drain plug socket Δ	1494T	T264
1	male oil drain plug socket with XZN® profile Ø	1494XZN	T264
1	oil plug wrenches	1496/C	T264
2	flat chisels, ribbed type 100 - 200 mm	35	T234
1	engineer's hammer 300 g	1370	T234
1	soft face hammer Ø 35 mm	1390	T234
1	Slip joint pliers boxed joints 250 mm	1048	T153
1	self - locking pliers 240 mm	1052	T153
1	half-round needle nose pliers ■ 180 mm	1150	T132
1	screwdrivers for slotted head screws ● 160 mm	1166	T132
1	heavy duty diagonal cutting nippers ⚡ 160 mm	1084	T132
11	3/4" square drive hexagon socket Ø 22-24-27-30-32-34-36-38-41-46-50 mm	928A	T105
1	3/4" drive extension bar 200 mm	928/21	T106
1	3/4" drive extension bar 380 mm	928/22	T106
1	3/4" drive sliding T - handle 450 mm	928/42	T106
1	3/4" drive reversible ratchet Ⓞ	928/55	T106
1	empty thermoformed tray	VP6	VP6
4	offset hexagon key wrenches Ø 13-14-17-19 mm	96N	
1	adjustable wrench 300 mm	111	
1	pry bar with handle	965	
1	tin snips 250 mm	1112	
1	electrician's scissors, straight blades	1128BMX	
1	engineer's hammer 1000 g	1370	
1	metric feeler gauge	1708/20	
1	telescopic magnet with flexible head	1712	
1	telescopic joint inspection mirror	1715	
1	three - cutting edges scraper 200 mm	1717B	
1	hacksaw frame, aluminium handle 440 mm	1726	
1	brake shoe cleaning brush plastic handle steel wires	1737NX	
1	metal oil can 200 cl	1751	
1	snap - off blade utility knife	1771	

Beta N. TR

Car repairs



Quantity/Description	Beta N.	TR	Quantity/Description	Beta N.	TR
16 combination wrenches 6÷21 mm	42	T15	1 extra long needle knurled nose pliers, bi-material handles ● 160 mm	1166BM	T131
5 combination wrenches 22 - 24 - 27 - 30 - 32 mm	42	T16	1 heavy duty diagonal cutting nippers 160 mm	1084BM	T131
6 double swivel end socket wrenches 8x9 - 10x11 - 12x13 - 14x15 - 16x17 - 18x19 mm	80	T79	1 slip joint pliers, push button alignment 240 mm	1047	T151
1 adjustable oil filter wrench 110 mm	1491	T264	1 self - locking pliers 240 mm	1057A	T151
1 square oil drain plug socket ■ 10 mm	1494	T264	8 T - handle wrenches with swivelling socket ○ 7 - 8 - 10 - 12 - 13 - 14 - 17 - 19 mm	952	T63
7 male hexagon oil drain plug sockets ○ 8-9-10-11-12-14-17 mm	1494E	T264	9 screwdrivers for cross head Phillips® screws ● 3x75 - 3,5x100 - 4x100 - 4x150 - 5,5x100 - 5,5x150 - 6,5x150 - 8x150 - 10x200 mm	1260N	T167
4 male square oil drain plug sockets ○ 8-9,5-12-13 mm	1494Q	T264	2 screwdrivers for slotted head screws, extra-short series ● 4x30 - 6,5x30 mm	31/B6	
1 male triangular oil drain plug socket Δ	1494T	T264	6 pin punches	1262	T168
1 male oil drain plug socket with XZN® profile ○	1494XZN	T264	7 screwdrivers for cross head Phillips® screws ● PH0x60 - PH0x100 - PH1x80 - PH1x120 - PH2x100 - PH2x150 - PH3x150 mm	1262N	T168
1 oil plug wrenches	1496/C	T264	2 screwdrivers for cross head Phillips® screws, extra - short series ● PH1x30 - PH2x30 mm	111	T59
5 1/2" drive, socket drivers for hexagon screws ○ 5 - 6 - 8 - 10 - 12 mm	920ME	T80	1 adjustable wrench 250 mm	920/40	T59
1 1/2" drive extension bar 125 mm	920/21	T80	1 1/2" drive swivel T-handle	951	T59
1 1/2" drive extension bar 255 mm	920/22	T80	6 T-handle wrenches with hexagon male ends ○ 2,5-3-4-5-6-8 mm	953	T59
1 1/2" drive universal joint	920/25	T80	4 T handle wrenches with swivelling hexagon male ends ○ 4-5-6-8 mm	1370	T59
1 1/2" drive sliding T-handle	920/42	T80	2 engineer's hammer 300-500 g	1262L	T209
1 1/2" drive reversible ratchet Ⓞ	920/55	T80	2 screwdriver for cross head Phillips® screws, long series ● PH1x400 - PH2x400 mm	1264L	T209
19 1/2" square drive hexagon sockets ○ 10÷24 - 26 - 27 - 30 - 32 mm	920A	T80	3 screwdriver for headless slotted screws, long series ● 3x300 - 4x400 - 5x400 mm	96BPC/SC9	
1 circlip pliers straight, internal ○ 180 mm	1032	T145	9 ball head offset hexagon key wrenches ○	666N/5	
1 circlip pliers bent, internal ○ 170 mm	1034	T145	1 click-type torque wrenches with reversible ratchets Ⓞ 8 ÷ 60 Nm	666N/30	
1 circlip pliers straight, external ● 175 mm	1036	T145	1 click-type torque wrenches with reversible ratchets Ⓞ 60 ÷ 330 Nm	720/C12	
1 circlip pliers bent, external ● 175 mm	1038	T145	1 adaptor, 1/2" female and 3/8" male drives	910/16	
1 circlip pliers straight, internal ○ 140 mm	1032	T146	1 assortment of 12 sockets and 5 accessories 3/4"	928A/C12	
1 circlip pliers bent, internal ○ 225 mm	1034	T146	3 lever with articulated, flat, curved head	966/C3	
1 circlip pliers straight, external ● 140 mm	1036	T146	1 dead blow hammer Ø 50 mm	1392	
1 circlip pliers bent, external ● 225 mm	1038	T146	1 Reversible impact wrench, made from composite material Ⓞ	1927P	
6 drivers for Torx® head screws, with handles ○ T10-T15-T20-T25-T27-T30	97TTX	T55			
12 swivel end ratcheting combination wrenches 8 - 9 - 10 - 11 - 12 - 13 - 14 - 15 - 16 - 17 - 18 - 19 mm	142SN	T46			
1 half-round needle nose pliers = 180 mm	1150BM	T131			

5935VG/1MB

assortment of 98 tools for tool chest C35, in soft foam trays

Car repair



MB11



MB36



MB46

Quantity/Description

- 21 combination wrenches 6-7-8-9-10-11-12-13-14-15-16-17-18-19-20-21-22-24-27-30-32 mm
- 8 double open end wrenches 6x7-8x9-10x11-12x13-14x15-16x17-18x19-20x22 mm
- 1 Slip joint pliers boxed joints 250 mm
- 19 1/2" square drive hexagon sockets 10-11-12-13-14-15-16-17-18-19-20-21-22-23-24-26-27-30-32 mm
- 1 1/2" wobble extension bar 125 mm
- 1 1/2" wobble extension bar 250 mm
- 1 1/2" drive universal joint
- 1 1/2" drive sliding T-handle
- 1 1/2" drive reversible ratchet
- 5 socket drivers for hexagon screws 5-6-8-10-12 mm
- 1 circlip pliers straight, internal 180 mm
- 1 circlip pliers bent, internal 170 mm
- 1 circlip pliers straight, external 175 mm
- 1 circlip pliers bent, external 175 mm

- | | |
|----------------|-------------|
| Beta N. | TR |
| 42 | MB11 |
| 55 | MB11 |
| 1048 | MB11 |
| 920A | MB36 |
| 920AN/125 | MB36 |
| 920AN/250 | MB36 |
| 920/25 | MB36 |
| 920/42 | MB36 |
| 920/55 | MB36 |
| 920PE | MB36 |
| 1032 | MB36 |
| 1034 | MB36 |
| 1036 | MB36 |
| 1038 | MB36 |

Quantity/Description

- 1 flat chisels, ribbed type 200 mm
- 1 heavy duty diagonal cutting nippers 160 mm
- 1 half-round needle nose pliers 180 mm
- 1 extra long needle knurled nose pliers, bi-material handles 160 mm
- 1 engineer's hammer 500 g
- 1 soft face hammer 35 mm
- 4 screwdrivers for cross head Phillips® screws 3x75-4x100-5x125-6,5x150 mm
- 3 screwdrivers for cross head Phillips® screws PH0x60-PH1x80--PH2x100 mm
- 6 drivers for Torx® head screws T8-T10-T15-T20-T25-T30
- 9 ball head offset hexagon key wrenches
- 6 offset hexagon key wrenches 2-2,5-3-4-5-6
- 1 self - locking pliers 240 mm

- | | |
|----------------|-------------|
| Beta N. | TR |
| 35 | MB36 |
| 1084BM | MB36 |
| 1150BM | MB36 |
| 1166BM | MB36 |
| 1370 | MB36 |
| 1390 | MB36 |
| 1260 | MB46 |
| 1262 | MB46 |
| 1267TX | MB46 |
| 96BPC/SC9 | MB46 |
| 96T | MB46 |
| 1052 | MB46 |

5940SBK

assortment of 125 tools

Motorcycle repairs

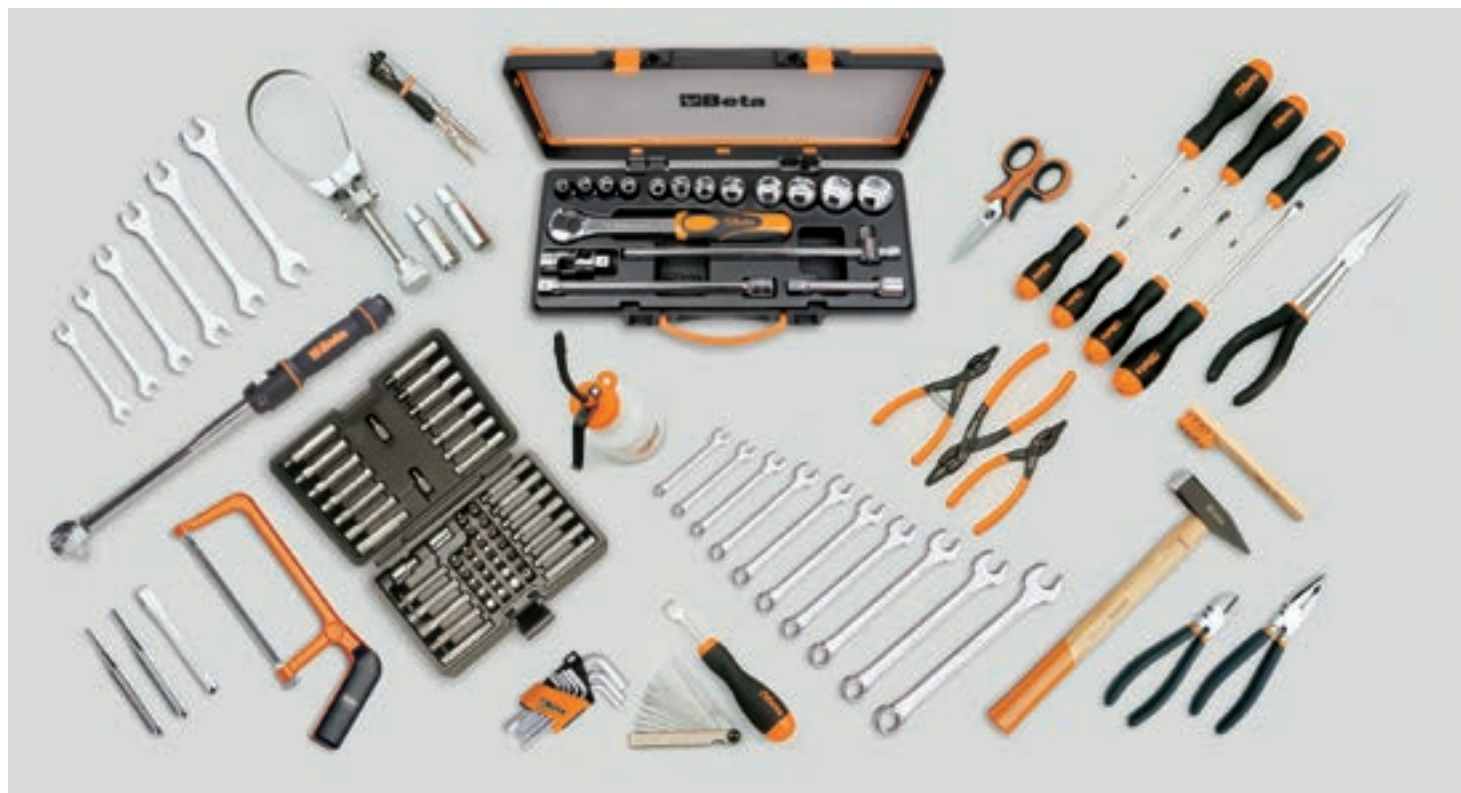

Quantity/Description

- 1 drift punches Ø 2 mm
- 1 centre punch Ø 4 mm
- 1 flat chisels 125 mm
- 10 combination wrenches 6 - 7 - 8 - 10 - 11 - 12 - 13 - 14 - 17 - 19 mm
- 6 double open end wrenches 6x7 - 8x9 - 10x11 - 12x13 - 14x15 - 16x17 mm
- 9 offset hexagon key wrenches \odot 1,5 - 2 - 2,5 - 3 - 4 - 5 - 6 - 8 - 10 mm
- 1 click-type torque wrenches with reversible ratchets \otimes 3/8", 8+60 Nm
- 54 assortment of 52 hexagon bits, 10 mm, and 2 accessories
- 17 assortment of 12 sockets and 5 accessories
- 1 adaptor, 1/2" female and 3/8" male drives
- 2 spark plug socket \odot 14 - 16 mm
- 1 extra - long nose pliers \bullet 283 mm
- 2 circlip pliers straight, internal \odot 140 - 180 mm
- 1 circlip pliers straight, external \bullet 140x1,3 mm

Beta N.

- 30
- 32
- 34
- 42
- 55
- 96/SC9
- 666N/5
- 867/C52
- 920A/C12X
- 910/16
- 956C
- 1009L/A
- 1032
- 1036

Quantity/Description

- 1 diagonal cutting nippers ∇ 160 mm
- 1 electrician's scissors, straight blades
- 1 half-round needle nose pliers \equiv 180 mm
- 1 screwdriver for Dzus® head screws \bullet
- 4 screwdrivers for cross head Phillips® screws \bullet 3x75 - 4x100 - 5,5x100 - 6,5x150 mm
- 3 screwdrivers for cross head Phillips® screws \oplus PH0x60 - PH1x80 - PH2x100 mm
- 1 circuit testing screwdriver \bullet
- 1 engineer's hammer 300 g
- 1 adjustable oil filter wrench
- 1 metric feeler gauge
- 1 mini hacksaw frame
- 1 brush, brass wires
- 1 plastic oil can 250 cc

Beta N.

- 1082
- 1128BM
- 1150
- 1201DZ
- 1201
- 1202
- 1254
- 1370
- 1491
- 1708/13
- 1725CR
- 1737
- 1754

5940SBK

059400082

Assortment recommended for use with items C41S - C41H - C42S - C42H - C42S - C41S

5941VU/M

assortment of 64 tools for trolley C41, in soft foam trays

Universal use



Quantity/Description	Beta N.	TR	Quantity/Description	Beta N.	TR
16 combination wrenches 6-7-8-9-10-11-12-13-14-15-16-17-18-19-21-22 mm	42	MC11	1 diagonal cutting nippers 160 mm	1082BM	
9 offset hexagon key wrenches \odot	96/SC9	MC11	1 electrician's scissors, straight blades 145 mm	1128BMX	
1 measuring tape 5 m	1692/5	MC11	1 half-round needle nose pliers 180 mm	1150BM	
19 1/2" square drive hexagon sockets \odot 10-11-12-13-14-15-16-17-18-19-20-21-22-23-24-26-27-30-32 mm	920A	MC21	1 extra long needle knurled nose pliers, bi-material handles \bullet 160 mm	1166BM	
1 1/2" drive universal joint	920/25	MC21	3 screwdrivers for cross head Phillips® screws \bullet 3,5x100-5,5x125-6,5x150 mm	1260	
1 1/2" drive sliding T-handle	920/42	MC21	3 screwdrivers for cross head Phillips® screws \oplus PH0-PH1-PH2	1262	
1 1/2" drive reversible ratchet \otimes	920/55	MC21	1 engineer's hammer 300 g	1370	
2 1/2" wobble extension bar 125-250 mm	920AN	MC21	1 snap - off blade utility knife 18 mm	1771	
1 adjustable wrench 250 mm	111				
1 Slip joint pliers boxed joints 250 mm	1048				

5941 VU-M

059410002

Assortment recommended in combination with C41H

Universal use



MM10



MM61



MM105



MM140



MM210

Quantity/Description

- 21 combination wrenches 6-7-8-9-10-11-12-13-14-15-16-17-18-19-20-21-22-24-27-30-32 mm
- 8 offset hexagon key wrenches \odot 2-2,5-3-4-5-6-7-8 mm
- 5 drivers for Torx® head screws, with handles \odot T10-T15-T20-T25-T30
- 1 engineer's hammer 300 g
- 1 soft face hammer \varnothing 35
- 2 flat chisels, ribbed type 100-200 mm
- 5 second cut files 200 mm
- 9 ball head offset hexagon key wrenches \odot 1,5-2-2,5-3-4-5-6-8-10 mm
- 1 socket holder \square 1/4 - \square 1/4
- 1 socket holder \square 1/4 - \square 3/8
- 1 socket holder \square 5/16 - \square 1/2
- 13 1/4" hexagon sockets \odot 4-4,5-5-5,5-6-7-8-9-10-11-12-13-14 mm
- 9 hexagon hand sockets, long series \odot 5-6-7-8-9-10-11-12-13 mm
- 5 1/4" socket drivers for hexagon screws \odot 3-4-5-6-7 mm
- 4 socket drivers for slotted head screws \bullet 0,8x4-1x5,5x1,2x6,5-1,2x8 mm
- 4 socket drivers for cross head Phillips® screws \oplus PH1-PH2-PH3-PH4
- 7 socket drivers for Torx® head screws \odot T10-T15-T20-T25-T27-T30-T40
- 1 adaptor, 1/4" female and 3/8" male drives \square 1/4 - \blacksquare 3/8
- 1 1/4" drive extension bar 50 mm
- 1 1/4" drive extension bar 100 mm
- 1 1/4" drive extension bar 150 mm
- 1 1/4" drive universal joint
- 1 1/4" drive spinner handle 176 mm
- 1 1/4" drive swivel T-handle 115 mm
- 1 1/4" reversible ratchet \odot 125 mm
- 17 hexagon hand sockets 3/8" \odot 6-7-8-9-10-11-12-13-14-15-16-17-18-19-20-21-22 mm
- 1 adaptor, 3/8" female and 1/4" male drives \square 3/8 - \blacksquare 1/4
- 1 adaptor, 1/2" female and 3/8" male drives \square 3/8 - \blacksquare 1/2
- 1 extension bar - 3/8" 125 mm
- 1 extension bar - 3/8" 250 mm

Beta N.	TR
42	MM10
96T	MM61
97TTX	MM140
1370	MM61
1390	MM61
35	MM61
1719BMA8/S5	MM61
96BPC/SC9	MM10
895/1	MM105
895/3	MM105
895/6	MM105
900	MM105
900L	MM105
900ME	MM105
900LP	MM105
900PH	MM105
900TX	MM105
900/16	MM105
900/20	MM105
900/20L	MM105
900/21	MM105
900/25	MM105
900BG/30	MM105
900/42	MM105
900/55	MM105
910A	MM105
910/15	MM105
910/16	MM105
910/21	MM105
910/22	MM105

Quantity/Description

- 1 3/8" drive universal joint
- 1 3/8" drive sliding T - handle 210 mm
- 1 3/8" drive reversible ratchet \odot 200 mm
- 21 1/2" square drive hexagon sockets \odot 8-10-11-12-13-14-15-16-17-18-19-20-21-22-23-24-26-27-28-30-32 mm
- 1 adaptor, 1/2" female and 3/8" male drives \square 1/2 - \blacksquare 3/8
- 1 1/2" drive universal joint
- 1 1/2" wobble extension bar 125 mm
- 1 1/2" wobble extension bar 250 mm
- 1 1/2" drive sliding T-handle 305 mm
- 1 1/2" drive reversible ratchet \odot 275 mm
- 3 3/8" square drive spark plug sockets \odot 16 mm (5/8")-17,8 (11/16")-20,8 (13/16")
- 1 heavy duty diagonal cutting nippers \sphericalangle 160 mm
- 1 half-round needle nose pliers \equiv 180 mm
- 1 extra long needle knurled nose pliers, bi-material handles \bullet 160 mm
- 1 circlip pliers straight, internal \square 19+60 mm
- 1 circlip pliers bent, internal \square 19+60 mm
- 1 circlip pliers straight, external \bullet 19+60 mm
- 1 circlip pliers bent, external \bullet 19+60 mm
- 1 Slip joint pliers boxed joints 250 mm
- 1 self - locking pliers 240 mm
- 38 microscrewdriver with 36 interchangeable 4-mm bits and magnetic extension
- 6 screwdrivers for cross head Phillips® screws \bullet 04x2,5x50-0,5x3x75-0,8x4x100-1,0x5,5x125-1,2x6,5x150-1,2x8x200 mm
- 1 screwdrivers for slotted head screws, extra-short series \bullet 0,8x4x30 mm
- 4 screwdrivers for cross head Phillips® screws \oplus PH0x60-PH1x80PH2x100PH3x150 mm
- 1 screwdrivers for cross head Phillips® screws, extra-short series \oplus PH1x30 mm
- 12 drivers for Torx® head screws, with handles \odot T06-T07-T08-T09-T10-T15-T20-T25-T27-T30-T40-T45
- 1 mains testing screwdriver \bullet 0,5x3,5x100 mm

Beta N.	TR
910/25	MM105
910/42	MM105
910/55	MM105
920A	MM105
920/15	MM105
920/25	MM105
920AN	MM105
920AN	MM105
920/42	MM105
920/55	MM105
956E	MM105
1084BM	MM140
1150BM	MM140
1166BM	MM140
1032	MM140
1034	MM140
1036	MM140
1038	MM140
1048	MM140
1052	MM140
1256/C36-2	MM140
1201	MM210
1201N	MM210
1202	MM210
1202N	MM210
1207TX	MM210
1253	MM210

Car repair



Quantity/Description

Quantity/Description	Beta N.
1 pin punches with handles 4 mm	31BM
5 combination wrenches 8-10-13-17-19 mm	42
9 ball head offset hexagon key wrenches \odot 1,5-2-2,5-3-4-5-6-8-10 mm	96BPC/SC9
2 reversible ratcheting combination wrenches 10-13 mm	142
1 hi-torque hexagon nut spinners short series \odot 7 mm	942BX
1 T-handle hexagon socket wrenches \odot 10 mm	950
1 T-handle spark plug wrenches with swivelling sockets 20,8 mm	957
1 slip joint pliers 250 mm	1048V
1 self-locking pliers 240 mm	1052
1 diagonal cutting nippers ∇ 160 mm	1082
1 electrician's scissors, straight blades 145 mm	1128BMX
1 half-round needle nose pliers \equiv 180 mm	1150

Quantity/Description

Quantity/Description	Beta N.
1 screwdrivers for slotted head screws \bullet 160 mm	1166
4 screwdrivers for cross head Phillips® screws \bullet 3x75 - 4x125 - 5,5x150 - 6,5x150 mm	1201
4 screwdrivers for cross head Phillips® screws \oplus PH0x60 - PH1x80 - PH2x00 - PH3x150 mm	1202
1 engineer's hammer 400 g	1370
1 soft face hammer \emptyset 35 mm	1390
1 spring pulling hook wrench 155 mm	1410M
1 measuring tape 3 m	1692/3
1 files 200 mm	1719BMD8/P
1 nylon cable ties 100 mm	1748N
1 nylon cable ties 300 mm	1748N
1 hacksaw frame, aluminium handle 300 mm	1725
1 snap-off blade utility knife 18 mm	1771

5941 KART

059410012

Assortment recommended in combination with C9 - C10 - C10S - C11 - CP15 - CP15PL - C16 - CP17 - CP17L - C18 - C41S - C41H

Car repairs

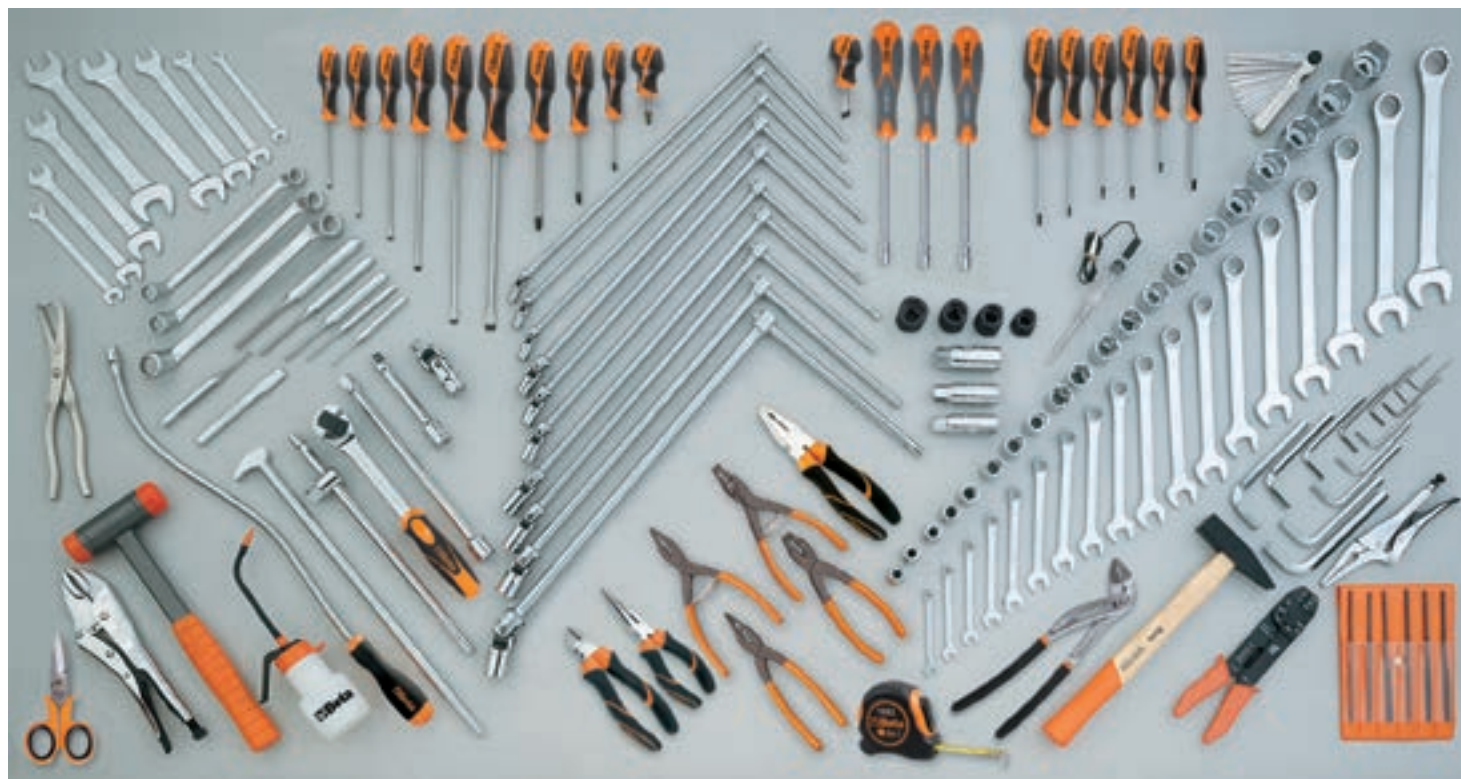

18.9 kg

Quantity/Description

5	pin punches Ø 2-3-4-5-6 mm
1	centre punch Ø 4 mm
1	flat chisels 125 mm
18	combination wrenches 6+22 - 24 mm
8	double open end wrenches 6x7 - 8x9 - 10x11 - 12x13 - 14x15 - 16x17 - 18x19 - 20x22 mm
3	double ended offset ring wrenches 12x13 - 14x15 - 17x19 mm
13	offset hexagon key wrenches ⌀ 2+10 - 12 mm
4	1/2" drive impact sockets ⌀ 17 - 19 - 21 - 22 mm
20	1/2" square drive hexagon sockets ⌀ 10-11-12-13-14-15-16-17-18-19-20-21-22-23-24-26-27-28-30-32 mm
1	1/2" drive extension bar
1	1/2" drive extension bar
1	1/2" drive universal joint
1	1/2" drive sliding T-handle
1	1/2" drive reversible ratchet
3	hi-torque hexagon nut spinners, long series ⌀ 8 - 10 - 13 mm
10	T - handle wrenches with swivelling socket ⌀ 6 - 7 - 8 - 10 - 11 - 12 - 13 - 14 - 17 - 19 mm
3	spark plug socket ⌀ 16 - 17,8 - 20,8 mm
1	pry bar
1	circlip pliers straight, internal
1	circlip pliers bent, internal
1	circlip pliers straight, external
1	circlip pliers bent, external
1	Slip joint pliers boxed joints 250 mm
1	self - locking pliers 240 mm

Beta N.

31
32
34
42
55
90
96
720
920A
920/21
920/22
920/25
920/42
920/55
943BX
952
956C
964
1032
1034
1036
1038
1048
1052

Quantity/Description

1	adjustable self locking pliers, long jaws 175 mm
1	diagonal cutting nippers 160 mm
1	electrician's scissors, straight blades
1	half-round needle nose pliers 180 mm
1	extra long needle knurled nose pliers, bi-material handles 160 mm
1	circuit testing screwdriver 6+24V
1	screwdrivers for cross head Phillips® screws 8 x 200 mm
1	screwdrivers for slotted head screws, extra-short series 6,5x30 mm
1	screwdrivers for cross head Phillips® screws 8 x 150 mm
1	screwdrivers for cross head Phillips® screws, extra - short series PH2x30 mm
5	drivers for Torx® head screws T8 - T10 - T15 - T20 - T25
8	screwdrivers
1	engineer's hammer 300 g
1	dead blow hammer Ø 35 mm
1	brake spring pliers 210 mm
1	crimping pliers for non insulated terminals
1	measuring tape 5 m
1	metric feeler gauge
1	flexible magnetic pick-up tool 1,8 kg
6	needle files 160 mm
1	plastic oil can 150 cc

Beta N.

1058
1082BM
1128BMX
1150BM
1166BM
1254
1260
1260N
1262
1262N
1267TX
1263/D8
1370
1392
1470
1603
1692
1708/20
1712E/2
1720/B6
1754

5954VG

059540054

Assortment recommended in combination with C54VG

Car repairs



36.6 kg

Quantity/Description

6	pin punches Ø 2 - 3 - 4 - 5 - 6 - 8 mm
6	2 drift punches, 1 centre punch, 3 flat chisels with metal holder
17	combination wrenches 6+22 - 24 - 27 - 30mm
12	double open end wrenches 6x7 ÷ 30x32 mm
8	offset hexagon key wrenches 2 ÷ 10 mm
1	offset hexagon key wrenches Ø 2,5 ÷ 12 mm
8	offset key wrenches, for Torx® head screws ⚙ T9 ÷ T40
5	offset key wrenches with XZN® profile Ø M5 ÷ M12
1	adjustable wrench 250 mm
1	click-type torque wrenches with reversible ratchets ⚙ 1/2", 40÷200 Nm
13	1/2" square drive hexagon sockets with rail Ø 10÷22 mm
8	1/2" square drive hexagon sockets with rail Ø 23÷32 mm
4	1/2" socket drivers for slotted head screws ● 1,2x6,5 - 1,2x8 - 1,6x9 - 2x12 mm
3	1/2" socket drivers for Phillips® screws ⚙ PH2 - 3 - 4
1	1/2" drive extension bar 125 mm
1	1/2" drive extension bar 255 mm
1	1/2" drive universal joint
1	1/2" drive sliding T-handle
1	1/2" drive reversible ratchet ⚙
2	1/2" drive impact sockets Ø 17 - 19 mm
10	T - handle wrenches with swivelling socket ○ 7 - 8 - 10 - 11 - 12 - 13 - 14 - 15 - 17 - 19 mm
3	T - handle swivel spark plug wrenches 14 - 16 - 20,8 mm
1	pry bar
1	wheel nut wrench ○ ■ 1/2" - 17 - 19 - 22 mm
2	circlip pliers straight, internal ○ 140 - 180 mm
2	circlip pliers bent, internal ○ 130 - 170 mm
2	circlip pliers straight, external ● 140x1,3 - 175 mm
2	circlip pliers bent, external ● 135x1,3 - 175 mm

Beta N.

31/SP6
38/SP6
42
55/S12X
96T/S8
96N/G7
97TX/SC8
98XZN/B5
111
666N/20
920A/SB13
920A/SB8
920LP
920PH
920/21
920/22
920/25
920/42
920/55
720
952
959
963
979
1032
1034
1036
1038

Quantity/Description

1	Slip joint pliers boxed joints 250 mm	1048
1	self - locking pliers 240 mm	1052
1	diagonal cutting nippers ⚡ 160 mm	1082BM
1	heavy duty diagonal cutting nippers ⚡ 160 mm	1084BM
1	toggle lever assisted end cutting nippers ⚡ 180 mm	1092V
1	tin snips 250 mm	1112
1	electrician's scissors, straight blades	1128BMX
1	half-round needle nose pliers = 180 mm	1150BM
1	extra long needle knurled nose pliers, bi-material handles ● 160 mm	1166BM
1	bent needle nose pliers ● 200 mm	1168BM
2	screwdrivers for cross head Phillips® screws ● 8x200 - 10x200 mm	1260
1	screwdrivers for cross head Phillips® screws ⚙ PH3x150 mm	1262
8	screwdrivers	1263/D8
2	engineer's hammer 300 - 600 g	1370
1	soft face hammer Ø 35 mm	1390
11	roller stud extractors M5÷M16 mm	1433/C11
1	adjustable oil filter wrench	1491
1	circuit tester	1498
1	measuring tape 5 m	1692
1	metric feeler gauge	1708/20
1	flexible magnetic pick-up tool 1,8 kg	1712E/2
1	two cutting edges scraper 200 mm	1717A
1	three - cutting edges scraper 200 mm	1717B
5	second cut files 200 mm	1719BMA8/S5
1	hacksaw frame, aluminium handle	1725
1	metal oil can 200 cc	1751
1	snap - off blade utility knife	1771
1	sliding gauge	1650

5957VG



059570007

Assortment recommended for use with items C57S A - C57S B - C57SP - C55PSP

SOFT MODULES

Assortment of tools in thermoformed trays,
designed for roller cabs

**SOFT
MODULE
SYSTEM**

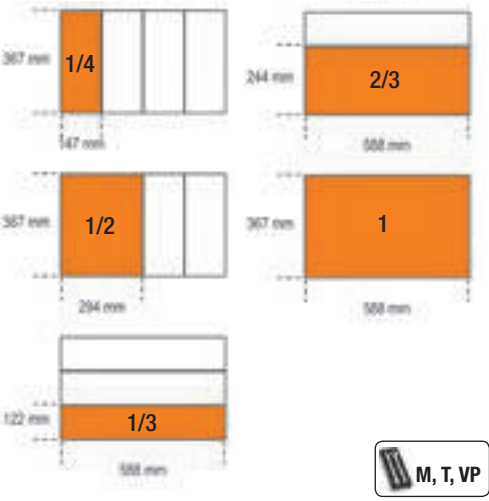
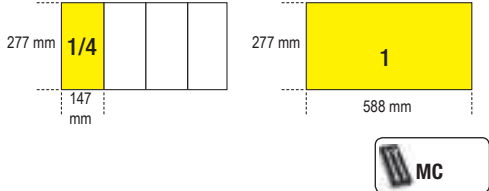
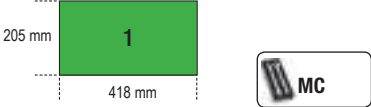
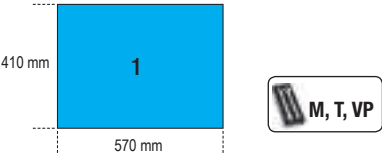
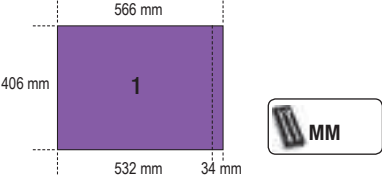
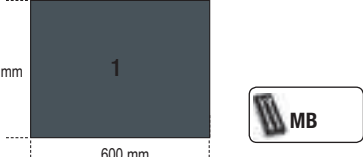
		
C23ST C24S C24SA C24SA-XL C24SL C28 C30S C37 C39 C39T C39MD C39SM C57S C59 RSC55		440÷448 453÷463
C22S C23S C23SC C27S		449 463
C41S C41H		449
C04TSS C38 C38T		453 463
C45		452
C35		449÷451



9899C1/4

plastic toolbox, empty, for hard and soft foam trays, 1/4 drawer

• Suitable for all types of T and M series foam trays, 1/4 drawer



9899C1/4 1 098990606

387x174x65 mm

M10

22

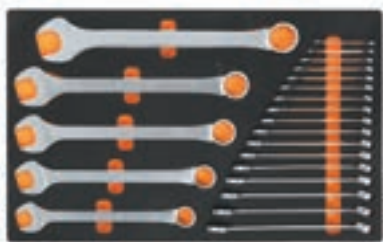

42 6-7-8-9-10-11-12-13-14-15-16-17-18-19-20-21-22-24-27-30-32-36 mm

4,5 kg

M10 1 024500010
MV10 1 024510010

M13

11



42SLIM 8-10-11-12-13-14-15-16-17-18-19 mm

1,2 kg

M13 1 024500013
MV13 1 024510013

M15

16



42 6-7-8-9-10-11-12-13-14-15-16-17-18-19-20-21 mm

1,5 kg

M15 1 024500015
MV15 1 024510015

M16

5



42 22-24-27-30-32 mm

2,1 kg

M16 1 024500016
MV16 1 024510016

M25

40



42 6-7-8-9-10-11-12-13-14-15-16-17-18-19-21-22-24-27 mm

90 6x7-8x9-10x11-12x13-14x15-16x17-18x19 mm

123Q1/4

123Q3/8

123Q1/2

142 8-9-10-11-12-13-14-15-16-17-18-19 mm

5,1 kg

M25 1 024500873
MV25 1 024510873

M30

31



55 6x7-8x9-10x11-12x13-14x15-16x17-18x19-20x22-21x23-24x27-30x32 mm

90 6x7-8x9-10x11-12x13-14x15-16x17-18x19-20x22-21x23-24x27-30x32 mm

96BPC/SC9 1,5-2-2,5-3-4-5-6-8-10 mm

4,2 kg

M30 1 024500030
MV30 1 024510030

M31

27



42AS 1/4-9/32-5/16-3/8-7/16-1/2-9/16-19/32-5/8-11/16-3/4-13/16-7/8-15/16-1-1-1/16-1-1/8-1-1/4

96BP/AS-SC9 1/16-3/32-1/8-5/32-3/16-7/32-1/4-5/16-3/8

4,5 kg

M31 1 024500031
MV31 1 024510031

M33

17



55 6x7-8x9-10x11-12x13-14x15-16x17-18x19-20x22 mm
96/SC9 1,5+10 mm

1,1 kg

M33 1 024500033
MV33 1 024510033

M38

4



55 21x23-24x26-27x29-30x32 mm

1,7 kg

M38 1 024500038
MV38 1 024510038

M40

7



90 6x7-8x9-10x11-12x13-14x15-16x17-18x19 mm

810 g

M40 1 024500040
MV40 1 024510040

Beta

M45



142 8-9-10-11-12
13-14-15-16
17-18-19 mm



1,3 kg



M45	1	024500045
MV45	1	024510045

M46



142SN 8-9-10-11-12
13-14-15-16
17-18-19 mm



1,4 kg



M46	1	024500046
MV46	1	024510046

M49

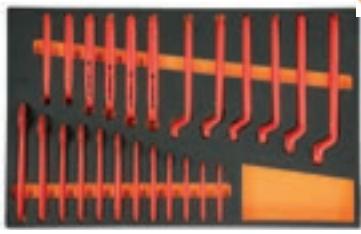

52MQ 7-8-10-11-12-13-14-15-16-17-19-22 mm
89MQ 7-8-10-11-12-13-14-15-16-17-19-22 mm



3,3 kg



M49	1	024500049
MV49	1	024510049

M50



○96T 2-2,5-3-4-5
6-7-8 mm



1,1 kg



M50	1	024500050
MV50	1	024510051

M52



○96T 2,5-3-4-5-6 mm



330 g



M52	1	024500052
MV52	1	024510052

M53

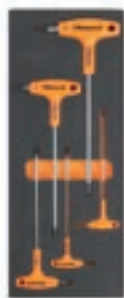

○96TBP 2,5-3-4-5-6 mm



350 g

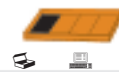

M53	1	024500053
MV52	1	024510052

M55



○97TTX T10-T15-T20-T25-T30



330 g

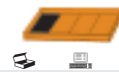

M55	1	024500055
MV55	1	024510055



M60



○96T 2-2,5-3-4-5-6-7-8-10 mm
○97BTX/SC8 T9-T10-T15-T20-T25-T27-T30-T40
○944BX 5-6-7-8-10-13 mm

1,9 Kg



M60	1	024500060
MV60	1	024510060

M62



97TTX T10-T15-T20-T25-T27-T30-T40-
T45-T50
1032 180 mm
1034 170 mm
1036 175 mm
1038 175 mm
1177BM 140 mm
1188BM 125 mm
1257LP 2-2,5-3-3,5 mm
1257PH 0-00

2,3 kg



M62	1	024500875
MV62	1	024510875

M63



○952 7-8-10-12-13-14-17-19 mm

3,4 kg



M63	1	024500063
MV63	1	024510063



M65

16

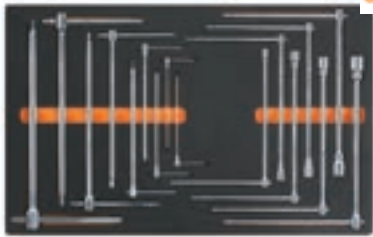

950 8-10-12-13-14-17-19 mm
951 2,5-3-4-5-6-8-10-12-14 mm

3,6 Kg



M65 1 024500065
MV65 1 024510065

M69

9



951 2,5-3-4-5-6-8
10-12-14 mm

1,8 kg



M69 1 024500069
MV69 1 024510069

M75

16



933 7-8-9-10-11-12-13-14-15
16-17-18-19-21-22-24 mm

5,5 kg



M75 1 024500075
MV75 1 024510075

Beta

M78

17



80 6x7-8x9-10x11-12x13-14x15-16x17-18x19 mm

920/36A

965 450 mm

1052 240 mm

1058 175 mm

1481PL/A

1481PL/B

1481PL/C

1650 150 mm

1708/20

1716P

4,4 kg



M78 1 024500878
MV77 1 024510876

M79

6



80 8x9-10x11-12x13-14x15-16x17-18x19 mm

1,3 kg



M79 1 024500079
MV79 1 024510079

M82

29



920A 10-11-12-13-14-15-16-17-18-19-20-21-22-23-24-26-27-30-32 mm

920ME 5-6-8-10-12 mm

920AN/125 125 mm

920AN/250 250 mm

920/25 255 mm

920/42 305 mm

920/55

4,1 kg

12"



M82 1 024500082
MV82 1 024510082

Beta

M83

24



920A 10-11-12-13-14-15-16-17-18-19-20-21-22-23-24-26-27-30-32 mm

920AN/125 125 mm

920AN/250 250 mm

920/25 255 mm

920/42 305 mm

920/55

3,7 kg

12"



M83 1 024500083
MV83 1 024510083

M85

45



851SR 230 mm

860LP 0,5x3 - 0,6x4,5 - 0,8x5,5 - 1x5,5 - 1,2x6,5 mm

860PE 2 - 2,5 - 3 - 4 - 5 - 6 - 8 - 10 mm

860PH PH0 - PH1 - PH2 - PH3 - PH4

860PZ PZ1 - PZ2 - PZ3 - PZ4

860TX T6-T7-T8-T9-T10-T15-T20-T25-T27-T30-T40

860RTX T9-T10-T15-T20-T25-T27-T30-T40

860/55 100 mm

882P 80 mm

892 1/4 - 1/4

450 g

1/4"



M85 1 024500085
MV85 1 024510085

M86

46



867PE 4-5-6-7-8-10-12 mm

867PE/L 4-5-6-7-8-10-12 mm

867XZN 5-6-8-10-12 mm

867TX T20-T25-T30-T40-T45-T50-T55

867TX/L T25-T30-T40-T45-T50-T55

867RTX T20-T25-T30-T40-T45-T50-T55

867/1

867/2

1,4 kg

10"



M86 1 024500086
MV86 1 024510086

Beta

M91



- 900 4-4,5-5-5,5-6-7-8-9-10-11-12-13-14 mm
- 900ME 2,5-3-4-5-6-8 mm
- 900/20 50 mm
- 900/21 150 mm
- 900/25 □ 1/4 - ■ 1/4
- 900BG/30
- 900/42
- ⊕ 900/55

560 g

14"

M91	1	024500091
MV90	1	024510090

M92



- 910A 6-7-8-9-10-11-12-13-14-15-16-17-18-19-20-21-22 mm
- 910/21 125 mm
- 910/22 250 mm
- 910/25
- 910/42
- ⊕ 910/55

1,5 kg

38"

M92	1	024500092
MV92	1	024510092

M94



- 900AS/L 3/16-7/32-1/4-9/32-5/16-11/32-3/8-7/16-1/2-9/16
- 900AS 3/16-7/32-5/32-1/4-9/32-5/16-11/32-3/8-7/16-1/2-9/16
- 900AN 50-100mm
- 900/25
- ⊕ 900/55
- 900/42

930 g

14"

M94	1	024500094
MV94	1	024510094

M96



- 920A/AS 3/8-7/16-1/2-9/16-19/32-5/8-11/16-3/4-25/32-13/16-7/8-15/16-1-1.1/16-1.1/18-1.3/16-1.1/4
- 920/25
- 920AN 125-250mm
- 920/42
- ⊕ 920/55

3,8 kg

12"

M96	1	024500096
MV96	1	024510096

M100

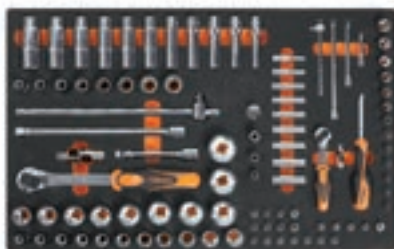

- 895/1
- 895/3
- 895/6
- 900 4-4,5-5-5,5-6-7-8-9-10-11-12-13-14 mm
- 900L 5-6-7-8-9-10-11-12-13 mm
- 900ME 3-4-5-6-7 mm
- 900LP 0,8x4-1x5,5-1,2x6,5-1,2x8 mm
- ⊕ 900PH PH1-PH2-PH3-PH4
- ⊕ 900TX T10-T15-T20-T25-T27-T30-T40
- 900/20 50 mm
- 900/20L 100 mm
- 900/21 150 mm
- 900/25
- 900BG/30
- 900/42
- ⊕ 900/55
- 920A 8-10-11-12-13-14-15-16-17-18-19-20-21-22-23-24-26-27-28-30-32 mm
- 920/15
- 920/25
- 920AN/125 125 mm
- 920AN/250 250 mm
- 920/42
- ⊕ 920/55
- 920FTX 10-12-14-16-18-20-22-24 mm

6,7 Kg

14" 12"

M100	1	024500100
MV100	1	024510100

Beta

M105



- 900 4-4,5-5-5,5-6-7-8-9-10-11-12-13-14 mm
- 900L 5-6-7-8-9-10-11-12-13 mm
- 96BPC/SC9 1,5-2-2,5-3-4-5-6-8-10 mm
- 895/1
- 895/3
- 895/6
- 900ME 3-4-5-6-7 mm
- 900LP 0,8x4-1x5,5-1,2x6,5-2x8 mm
- ⊕ 900PH PH1-PH2-PH3-PH4
- ⊕ 900TX T10-T15-T20-T25-T27-T30-T40
- 900/16 □ 1/4 - ■ 3/8
- 900/... 50-100-150 mm
- 900/25
- 900BG/30
- 900/42
- ⊕ 900/55
- 910A 6-7-8-9-10-11-12-13-14-15-16-17-18-19-20-21-22 mm
- 910/15 □ 3/8 - ■ 1/4
- 910/16 □ 3/8 - ■ 1/2
- 910/21 125 mm
- 910/22 250 mm
- 910/25
- 910/42
- ⊕ 910/55
- 920A 8-10-11-12-13-14-15-16-17-18-19-20-21-22-23-24-26-27-28-30-32 mm
- 920/15 □ 1/2 - ■ 3/8
- 920/25
- 920AN 125 - 250 mm
- 920/42
- ⊕ 920/55
- 956E 16-17,8-20,8 mm

7,7 kg

14" 38" 12"

M105	1	024500871
MV105	1	024510871

M108

27



- 910MQ/PE 4-5-6-8 mm
- 910MQ/B 7-8-10-11-12-13-14-15-16-17-19 mm
- ⊗ 910MQ/TX T15-T20-T25-T27-T30-T40
- 910MQ/XZN 8-10 mm
- 910MQ/21 125 mm
- 910MQ/22 250 mm
- 910MQ/T
- 910MQ/55

2,7 kg



M108	1	024500108
MV108	1	024510108

M110

36



- ⊗ 850MQ
- ⊗ 860TX/A10
- 920MQ/A 8-9-10-11-12-13-14-15-16-17-18-19-20 mm
- 920MQ/PE 5-6-8-10-12 mm
- 920MQ/21 125 mm
- 920MQ/22 250 mm
- 920MQ/55A
- 943MQ 6-7-8-10 mm

3,1 kg



M110	1	024500110
MV110	1	024510110

M112

32



- ⊗ 861TX ● 1/4-T6+T15
- ⊗ 866TX ● 5/16-T20+T55
- 895/1 ○ 1/4x□1/4
- 895/6 ○ 5/16x□1/2
- ⊗ 900FTX □ 1/4-E4+E10
- ⊗ 920FTX □ 1/2-E12+E24
- ⊗ 920TX □ 1/2-T55L-T60-T70L

1,3 kg

14" 12"



M112	1	024500112
MV112	1	024510112

M120

75



- 920A 10-11-12-13-14-15-16-17-18-19-20-21-22-24-26-27-30-32 mm
- 920AN/125 125 mm
- 920AN/250 250 mm
- 920/25
- 920/42
- 920AL 10-12-13-14-15-16-17-18-19-22-24-27-30-32 mm
- ⊗ 920FTX 10-12-14-16-18-20-22-24 mm
- ⊗ 920/55
- 920PE 5-5L-6-6L-7-7L-8-8L-10-10L-12-12L-14-14L
- ⊗ 920TX T20-T25-T27-T30-T40-T45-T50-T55-T60-T20L-T25L-T27L-T30L-T40L-T45L-T50L

6,9 Kg

12"



M120	1	024500120
MV120	1	024510120

M121

46

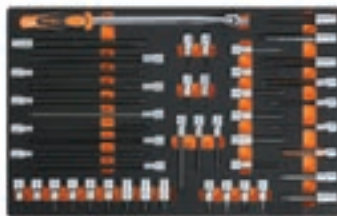

- 920BP 5L-6L-8L-10L-5XL-6XL-8XL mm
- ⊗ 920TX T20-T25-T27-T30-T40L-T45L-T50L-T55L-T60L-T70L
- 920XZN 4-5-6-6L-8-8L-10-10L-12-12L-14-14L-16-18 mm
- ⊗ 920ES 7-9-10-11-12L-14L-16L-7XL-9XL-10XL-11XL-12XL-14XL-16XL mm

6,3 Kg

12"



M121	1	024500121
MV121	1	024510121

M125

68



- 910AL 8-9-10-11-12-13-14-15-16-17-19-21-22 mm
- 920PE 5-6-6L-7-8-8L-10-10L-12-12L mm
- ⊗ 920FTX E12-E14-E16-E18-E20-E22-E24
- ⊗ 920TX T20-T25-T27-T30-T30L-T40-T40L-T45-T50-T50L-T55-T60-T60L
- 920XZN 5-6-6L-8-8L-10-10L-12L mm
- 920AL 10-12-13-14-15-16-17-18-19-21-22-23-24-27-30-32 mm

7,9 kg

38" 12"



M125	1	024500872
MV125	1	024510872

M128

50



- 720 10-11-12-13-14-15-16-17-18-19-21-22-24-27-30-32 mm
- 720L 10-11-12-13-14-15-16-17-18-19-21-22-24-27-30-32 mm
- ⊗ 720TX T30-T40-T45-T50-T55
- 720ME 5-6-8-10-12-14-17-19 mm
- 720LC 17-19-21 mm
- 720/21 125 mm
- 720/25

8,9 kg

12"



M128	1	024500128
MV128	1	024510128

M130

13



- 1032 180 mm
- 1034 170 mm
- 1036 175 mm
- 1038 175 mm
- 1048 250 mm
- 1052 240 mm
- ⊗ 1082BM 160 mm
- 1098 220 mm
- 1112 250 mm
- 1128BM
- 1150BM 180 mm
- 1166BM 160 mm
- 1168BM 160 mm

3,4 Kg



M130	1	024500130
MV130	1	024510130

M131

3



- ⊗ 1084BM 160 mm
- 1150BM 180 mm
- 1166BM 160 mm

750 g



M131	1	024500131
MV131	1	024510131

M132



- 1084 160 mm
- 1150 180 mm
- 1166 160 mm



650 g



M132	1	024500132
MV132	1	024510132

M135



- 1082MQ 160 mm
- 1150MQ 180 mm
- 1166MQ 160 mm



750 g



M135	1	024500135
MV135	1	024510135

M145



- 1032 180 mm
- 1034 170 mm
- 1036 175 mm
- 1038 175 mm



640 g



M145	1	024500145
MV145	1	024510145

M153



- 1048 250 mm
- 1052 240 mm



1 kg



M153	1	024500153
MV153	1	024510153

M161



- 1128MQ
- 1048MQ 250 mm
- 1082MQ 160 mm
- 1150MQ 180 mm
- 1162MQ 160 mm
- 1164MQ 160 mm
- 1272MQ PH0x60 - PH1x80 - PH2x100 - PH3x150 mm
- 1274MQ 2,5x75 - 3x100 - 4x100 - 5,5x125 mm
- 1777MQ/U



3,0 kg



M161	1	024500161
MV161	1	024510161

M165



- 860MIX/A31
- 1048 250 mm
- 1082BM 160 mm
- 1150BM 180 mm
- 1162BM 160 mm
- 1290 3x75-4x100-5,5x100-6,5x150-8x150 mm
- 1290N 6,5x30 mm
- 1292 4,5x80-6x100-8x150 mm
- 1292N 6x30 mm
- 1297TX T20-T25-T27-T30



2,9 kg



M165	1	024500874
MV165	1	024510874

M170



- 1290 2,5x50
- 3x75
- 3,5x100
- 4x125
- 5,5x100
- 5,5x150
- 6,5x150 mm



500 g



M170	1	024500170
MV170	1	024510170

M172



- 1292 PH0x60
- PH0x100
- PH1x80
- PH1x120
- PH2x100
- PH2x150 mm



450 g



M172	1	024500172
MV172	1	024510172

M174



- 1297TX T8-T10-T15-T20-T25-T30



450 g



M174	1	024500174
MV174	1	024510174

M180



- 1290 3x75
- 4x100
- 5,5x150
- 6,5x150 mm
- 1292 PH0x60
- PH1x80
- PH2x100 mm



500 g



M180	1	024500180
MV180	1	024510180



M195

25

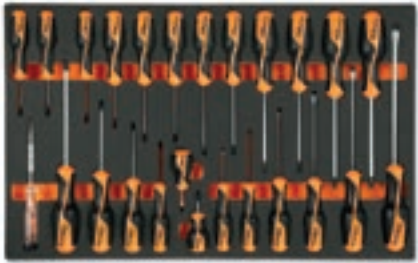

- 1260 2,5x50-3x75-4x100-5,5x125-6,5x150-8x200 mm
- 1260N 4x30 mm
- ⊕ 1262 PH0x60-PH1x80-PH2x100-PH3x150 mm
- ⊕ 1262N PH1x30 mm
- ⊖ 1267TX T6-T7-T8-T9-T10-T15-T20-T25-T27-T30-T40-T45
- 1253 3,5x100 mm

2,3 kg



M195	1	024500195
MV195	1	024510195

M199

7



- 1260 2,5x50-3x75-3,5x100-4x125-5,5x100-5,5x150-6,5x150 mm

500 g



M199	1	024500199
MV199	1	024510199

M202

6



- ⊕ 1262 PH0x60-PH0x100-PH1x80-PH1x120-PH2x100-PH2x150 mm

450 g



M202	1	024500202
MV202	1	024510202

Beta

M204

6



- ⊖ 1267TX T8-T10-T15-T20-T25-T30

450 g



M204	1	024500204
MV204	1	024510204

M208

10



- 1260 3x75-3,5x100-4x125-5,5x150-6,5x150 mm
- ⊕ 1262 PH0x60-PH1x80-PH2x100-4x30 mm
- 1260N PH1x30 mm
- ⊕ 1262N PH1x30 mm

750 g



M208	1	024500208
MV208	1	024510208

M209

10



- 1260N 4x30 mm
- 1264 2,5x60 - 3x100 - 4x125 - 5x150 - 6,5x150 mm
- ⊕ 1262 PH0x60 - PH1x80 - PH2x100 mm
- ⊕ 1262N PH1x30 mm

820 g



M209	1	024500209
MV208	1	024510208

M210

25



- 1201 2,5x50-3x75-4x100-5,5x125-6,5x150-8x200 mm
- 1201N 4x30 mm
- ⊕ 1202 PH0x60-PH1x80-PH2x100-PH3x150 mm
- ⊕ 1202N PH1x30 mm
- ⊖ 1207TX T6-T7-T8-T9-T10-T15-T20-T25-T27-T30-T40-T45
- 1253

1,8 Kg



M210	1	024500210
MV210	1	024510210

M211

7



- 1201 2,5x50-3x75-3,5x100-4x125-5,5x100-5,5x150-6,5x150 mm

500 g



M211	1	024500211
MV211	1	024510211

M212

6



- ⊕ 1202 PH0x60-PH1x80-PH1x120-PH2x100-PH2x150-PH3x150 mm

450 g



M212	1	024500212
MV212	1	024510212

Beta

Beta

M215



1207TX T6-T7-T8-T9-T10-T15-T20

500 g



M215	1	024500215
MV215	1	024510215

M220



1201 3x75
4x100
5,5x150
6,5x150 mm
1202 PH0x60
PH1x80
PH2x100 mm

500 g



M220	1	024500220
MV220	1	024510220

M221



1202 3x60 - 4,5x80 - 6x100 mm
1204 3x75 - 4x100 - 5x150 - 6,5x150 mm

590 g



M221	1	024500221
MV220	1	024510220

M223



1272MQ PH0x60 mm
1272MQ/F PH1x80
PH2x100 mm
1274MQ/F 3,5x100
4,5x100
5,5x125
6,5x150 mm

620 g



M223	1	024500223
MV226	1	024510226

M224



1272MQ PH0x60
PH1x80
PH2x100 mm
1274MQ/F 3,5x100
4,5x100
5,5x125
6,5x150 mm

630 g



M224	1	024500224
MV226	1	024510226

M226



1274MQ 3x100
4x100
5,5x125
6,5x150 mm
1272MQ PH0x60
PH1x80
PH2x100 mm

500 g



M226	1	024500226
MV226	1	024510226

M227



944BX 6-7-8-10-13 mm

420 g



M227	1	024500227
MV227	1	024510227

M230



30 Ø 2-3-4 mm
31 Ø 2-3-4-5-6-8 mm
32 Ø 4 mm
34 150 mm
35 200-250 mm
36 125 mm
1370 500 g
1390 Ø 35 mm
1692 3 m
1712TF
1719BMA/Q 200 mm
1719BMA/T 200 mm
1719BMA/P 200 mm
1719BMA/M 200 mm
1719BMA/R 200 mm
1737NX
1771 18 mm

3,2 Kg



M230	1	024500230
MV230	1	024510230

M231



31 2-3-4-5-6-8 mm
32 4 mm
34 125-150-175 mm
36 125 mm
1370 500-1000 g
1390 Ø 35 mm
1712TF 590 mm
1715 670 mm
1719BMA8/Q 200 mm
1719BMA8/T 200 mm
1719BMA8/P 200 mm
1719BMA8/M 200 mm
1719BMA8/R 200 mm
1737NX

4,7 kg



M231	1	024500877
MV231	1	024510877

Beta

Beta

M234

4



35 100-200 mm
 1370 300 g
 1390 Ø 35 mm

1,3 kg



M234 1 024500234
 MV232 1 024510232

M236

5



■ 1719BMA/Q 200 mm
 ▲ 1719BMA/T 200 mm
 ■ 1719BMA/P 200 mm
 ▶ 1719BMA/M 200 mm
 ● 1719BMA/R 200 mm

870 g



M236 1 024500236
 MV236 1 024510236

M237

5



35 100-200 mm
 1370T 300 mm
 1390N Ø 35 mm

1,3 kg

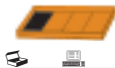

M237 1 024500237
 MV232 1 024510232

M240

7



31BM Ø 2-3-4-5-6-8 mm
 32 Ø 4 mm

850 g



M240 1 024500240
 MV240 1 024510240

M264

16



1491 Ø 65+110 mm
 ■ 1494 ■ 10 mm
 ○ 1494E ○ 8-9-10-11-12-14-17 mm
 ○ 1494Q ○ 8-9,5-12-13 mm
 △ 1494T △ 9,5
 ○ 1494XZN ○ 16
 1496C ■ 8x ■ 10 mm

2,1 kg



M264 1 024500264
 MV264 1 024510264

M284

9



1128BMX
 1130BMX
 1719BMA...Q 200 mm
 1719BMA...P 200 mm
 1719BMA...M 200 mm
 1719BMA...R 200 mm
 1726BM 400 mm
 1728BM (5)
 1771BM 170 mm
 1778V18 185 mm

2,4 Kg



M284 1 024500284
 MV284 1 024510284

M285

4



1112 250 mm
 1128BM
 1726 440 mm
 1728BM (5)
 1753 200 cc

1,5 kg



M285 1 024500285
 MV285 1 024510285

M289

4



1692 5 m
 1725CR
 1755 30 cc
 1771

500 g



M289 1 024500289
 MV289 1 024510289

M295

4



1650
 1682 L=300 mm
 1707
 1708/20

450 g

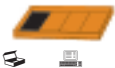

M295 1 024500295
 MV295 1 024510295

M305

14



1927B
 ○ 720 12-13-14-15-16-17
 18-19-21-22
 24-27 mm
 720/21

4,2 kg

12³

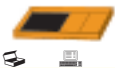

M305 1 024500305
 MV305 1 024510305

M310

14



1927CD
 ○ 720 12-13-14-15-16-17
 18-19-21-22
 24-27 mm
 720/21

4,0 kg

12³



M310 1 024500310
 MV310 1 024510310

MC10

34



42	6-7-8-9-10-11-12 13-14-15-16-17 18-19-21-22 mm
96/SC9	1,5-2-2,5-3-4-5-6-8-10 mm
1084BM	160 mm
1150BM	180 mm
1166BM	160 mm
1201	3,5x100-5,5x150-6,5x150 mm
1202	PH0x60-PH1x80-PH2x100 mm

3,5 kg



MC10	1 027500010
MCV10	1 027510010

MC11

26



42	6-7-8-9-10-11-12-13-14-15-16-17-18-19- 21-22 mm
96/SC9	1,5-2-2,5-3-4-5-6-8-10 mm
1692/5	5 m

2,2 kg



MC11	1 041500011
MCV11	1 041510011

Beta

MC20

74



860MIX/A31	
895/1	
1048	250 mm
1370	300 g
32	Ø 4 mm
36	Ø 4 mm
900	4-4,5-5-5,5-6-7-8-9-10-11-12-13-14 mm
900/21	150 mm
900/25	
900BG/30C	
900/42	
900/55	
920A	10-11-12-13-14-15-16-17-18-19-21-22- 24-27-30-32 mm
920/25	
920AN/125	125 mm
920/42	
920/55	

6 kg

12"



MC20	1 027500020
MCV20	1 027510020

MC21

24



920A	10-11-12-13-14-15-16-17-18-19-20-21- 22-23-24-26-27-30-32 mm
920/25	
920/42	
920/55	
920AN	125-250 mm

4,3 kg



MC21	1 041500021
MCV21	1 041510021

MB11

30



42	6-7-8-9-10-11-12-13-14-15-16-17-18-19- 20-21-22-24-27-30-32 mm
55	6x7-8x9-10x11 12x13-14x15 16x17-18x19 20x22 mm
1048	250 mm

5,4 kg



MB11	1 024504211
MBV11	1 024524211

MB34

52



○ 920A	10-11-12-13-14-15-16-17-18-19-20-21- 22-23-24-26-27-30-32 mm
920/21	125 mm
920/22	150 mm
920/25	
920/42	
⊗ 920/55	
111	250 mm
1052	240 mm
1084BM	160 mm
1150BM	180 mm
1166BM	160 mm
○ 1032	180 mm
○ 1034	170 mm
● 1036	175 mm
● 1038	175 mm
○ 900	4-4,5-5-5,5-6-7-8-9-10-11-12-13-14 mm
900/20	50 mm
900/21	150 mm
900/25	
900BG/30	
⊗ 900/55	
900/42	

7,0 kg

14" 12"



MB34	1 024504234
MBV34	1 024524234

Beta

Beta

MB35

80



- 96T 2-2,5-3-4-5-6-7-8 mm
- 851SR 230 mm
- 860LP 0,5x3 - 0,6x4,5 - 0,8x5,5 - 1x5,5 - 1,2x6,5 mm
- 860PE 2 - 2,5 - 3 - 4 - 5 - 6 - 8 - 10 mm
- ⊕ 860PH PH0 - PH1 - PH2 - PH3 - PH4
- ⊕ 860PZ PZ1 - PZ2 - PZ3 - PZ4
- ⊕ 860RTX T9-T10-T15-T20-T25-T27-T30-T40
- ⊕ 860TX T6-T7-T8-T9-T10-T15-T20-T25-T27-T30-T40
- 860/55 100 mm
- 882P 80 mm
- 892/0
- 920A 10-11-12-13-14-15-16-17-18-19-20-21-22-24-26-27-30-32 mm
- 920/21 125 mm
- 920/22 250 mm
- 920/25
- 920/42
- ⊕ 920/55
- ⊖ 1084BM 160 mm
- ≡ 1150BM 180 mm
- 1166BM 160 mm

5,9 kg

12"

MB35 1 024504235
MBV35 1 024524235

MB36

39



- 920A 10-11-12-13-14-15-16-17-18-19-20-21-22-24-26-27-30-32 mm
- 920/21 125 mm
- 920/22 250 mm
- 920/25
- 920/42
- ⊕ 920/55
- 920PE 5-6-8-10-12 mm
- 1032 180 mm
- 1034 170 mm
- 1036 175 mm
- 1038 175 mm
- 35 200 mm
- ⊖ 1084BM 160 mm
- ≡ 1150BM 180 mm
- 1166BM 160 mm
- 1370 500 g
- 1390 35 mm

7,2 kg

12"

MB36 1 024504236
MBV36 1 024524236

MB44

34

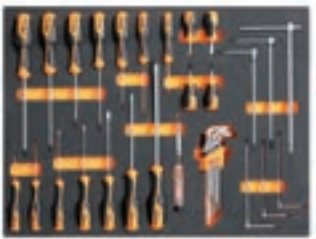

- 1260 2,5x50-3x75-3,5x100-4x100-5,5x125-6,5x150-8x200 mm
- 1260N 4x30-6,5x30 mm
- ⊕ 1262 PH0x60-PH0x100-PH1x80-PH1x120-PH2x100-PH2x150-PH3x150 mm
- ⊕ 1262N PH1x30-PH2x30 mm
- 1253
- 96BPC/SC9
- 951 2,5-3-4-5-6-8 mm

2,8 kg

MB44 1 024504244
MBV44 1 024524244

MB45

29



- 1260 2,5x50-3x75-3,5x100-4x100-5,5x100-5x125-6,5x150 mm
- ⊕ 1262 PH0x60-PH0x100-PH1x80-PH1x120-PH2x100-PH2x150 mm
- ⊕ 1267TX T8-T10-T15-T20-T25-T30
- 1052 240 mm
- 96BPC/SC9

2,8 kg

MB45 1 024504245
MBV45 1 024524245

MB46

29



- 1260 3x75-4x100-5,5x125-6,5x150 mm
- ⊕ 1262 PH0x60-PH1x80--PH2x100 mm
- ⊕ 1267TX T8-T10-T15-T20-T25-T30
- 96BPC/SC9
- 96T 2-2,5-3-4-5-6
- 1052 240 mm

2,8 kg

MB46 1 024504246
MBV46 1 024524246

MB47

48



- 1260 3x75-4x100-5,5x125-6,5x150 mm
- ⊕ 1262 PH0x60-PH1x80--PH2x100 mm
- 1260N 4x30 mm
- ⊕ 1262N PH1x30 mm
- 96T 2,5-3-4-5-6-8 mm
- 96BPC/SC9
- 920A 10-11-12-13-14-15-16-17-18-19-20-21-22-23-24-26-27-30-32 mm
- 920/21 125 mm
- 920/22 250 mm
- 920/25
- 920/42
- ⊕ 920/55

5,6 kg

12"

MB47 1 024504247
MBV47 1 024524247

MB56

15



- 1719BMA/Q 200 mm
- ▲ 1719BMA/T 200 mm
- 1719BMA/P 200 mm
- ▶ 1719BMA/M 200 mm
- 1719BMA/R 200 mm
- 1032 180 mm
- 1034 170 mm
- 1036 175 mm
- 1038 175 mm
- 1370T 300 g
- 1390N Ø 35 mm
- 35 200 mm
- 1692 5 mt
- 1725 260 mm
- 1771 18 mm

3,7 kg

MB56 1 024504256
MBV56 1 024524256

 **Beta**

MB57

15



- 1719BMA/Q 200 mm
- ▲ 1719BMA/T 200 mm
- 1719BMA/P 200 mm
- 1719BMA/M 200 mm
- 1719BMA/R 200 mm
- 31 Ø 4-6 mm
- 32 Ø 4 mm
- 35 125-200 mm
- 1370 300 g
- 1390 Ø 35 mm
- 1692 5 mt
- 1725 420 mm
- 1835

3,4 kg



MB57	1	024504257
MBV57	1	024524257

MB58

17



- 31 Ø 2-3-4-5-6 mm
- 32 Ø 4 mm
- 35 200 mm
- 1112 250 mm
- 1128BMX
- 1370 500 g
- 1390 Ø 45 mm
- 1719BMA...Q 200 mm
- 1719BMA...T 200 mm
- 1719BMA...P 200 mm
- 1719BMA...M 200 mm
- 1719BMA...R 200 mm
- 1726 440 mm

4,5 kg



MB58	1	024504258
MBV58	1	024524258

MB61

16

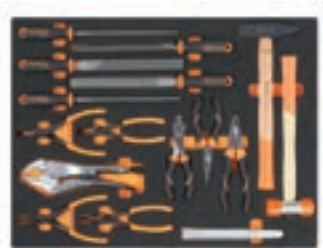

- 1719BMA/Q 200 mm
- 1719BMA/P 200 mm
- ▲ 1719BMA/T 200 mm
- 1719BMA/M 200 mm
- 1719BMA/R 200 mm
- 35 200 mm
- 1032 180 mm
- 1034 170 mm
- 1036 175 mm
- 1038 175 mm
- 1052 240 mm
- ◄ 1084BM 160 mm
- ▬ 1150BM 180 mm
- 1166BM 160 mm
- 1370 500 g
- 1390 Ø 35 mm

4,8 kg



MB61	1	024504261
MBV61	1	024524261

MB63

60



- 96BPC/SC9
- 1250 4x125 mm
- 1251 PH1x150 mm
- 1253
- 943MQ 5,5-6-7-8-10-13 mm
- 1272MQ PH0x60-PH1x80-PH2x100-PH3x150 mm
- 1274MQ 2,5x75-3x100-4x100-5,5x125-6,5x150-8x175 mm
- 860LP 0,5x3 - 0,6x4 - 0,8x5,5 - 1,0x5,5 - 1,2x6,5 mm
- 860PE 2 - 2,5 - 3 - 4 - 5 - 6 - 8 - 10 mm
- 860PH PH0 - PH1 - PH2 - PH3 - PH4
- 860PZ PZ1 - PZ2 - PZ3 - PZ4
- 860RTX T9 - T10 - T15 - T20 - T25 - T27 - T30 - T40
- 882MSR/50 ○ 1/4 ● 1/4
- ⑩ 850MQ

3,2 kg



MB63	1	024504263
MBV63	1	024524263

MB64

20



- 55 6x7-8x9-10x11 - 12x13-14x15 - 16x17-18x19 - 20x22 mm
- 1048MQ 250 mm
- ◄ 1082MQ 140 mm
- 1128BSX
- 1132MQ 230 mm
- 1142MQ 160 mm
- ▬ 1150MQ 180 mm
- 1166MQ 160 mm
- 1168MQ 160 mm
- 110MQ 250 mm
- 1777MQ
- 993MQ
- 1602

4,1 kg



MB64	1	024504264
MBV64	1	024524264

MM10

30



42 6-7-8-9-10-11-12-13-14-15-16-17-18-19-20-21-22-24-27-30-32 mm
 96BPC/SC9 1,5-2-2,5-3-4-5-6-8-10 mm

4,5 kg



MM10	1	024580010
MMV10	1	024590010

MM61

17



96T 2-2,5-3-4-5-6-7-8 mm
 1390 Ø 35
 1370 300 g
 35 100-200 mm
 1719BMA8/S5 200 mm

2,9 kg



MM61	1	024580061
MMV61	1	024590061

MM105

107

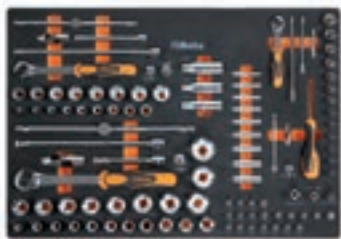

895/1 □1/4 □1/4
 895/3 □1/4 □3/8
 895/6 □5/16 □1/2
 900 4-4,5-5-5,5-6-7-8-9-10-11-12-13-14 mm
 900L 5-6-7-8-9-10-11-12-13 mm
 900ME 3-4-5-6-7 mm
 900LP 0,8x4-1x5,5-1,2x6,5-1,2x8
 900PH PH1-PH2-PH3-PH4
 900TX T10-T15-T20-T25-T27-T30-T40
 900/16 50-100-150 mm
 900/25 176 mm
 900BG/30 115 mm
 900/42 125 mm
 900/55 6-7-8-9-10-11-12-13-14-15-16-17-18-19-20-21-22 mm
 910A □3/8 ■1/4
 910/15 □3/8 ■1/2
 910/16 125 mm
 910/21 250 mm
 910/22 210 mm
 910/25 200 mm
 910/42 8-10-11-12-13-14-15-16-17-18-19-20-21-22-23-24-26-27-28-30-32 mm
 910/55 □1/2 ■3/8
 920A 125-250 mm
 920/15 305 mm
 920/25 275 mm
 920AN 16 mm (5/8")-17,8 (11/16")-20,8 (13/16")
 920/42
 920/55
 956E

7,2 kg

14" 38" 12"



MM105	1	024580105
MMV105	1	024590105

MM140

52



97TTX T10-T15-T20-T25-T30
 1084BM 160 mm
 1150BM 180 mm
 1166BM 160 mm
 1032 180 mm
 1034 170 mm
 1036 175 mm
 1038 175 mm
 1048 250 mm
 1052 240 mm
 1256/C36-2

2,2 kg



MM140	1	024580140
MMV140	1	024590140

MM210

25



1201 2,5x50-3x75-4x100-5,5x125-6,5x150-8x200 mm
 1201N 4x30 mm
 1202 PH0x60-PH1x80-PH2x100-PH3x150 mm
 1202N PH1X30 mm
 1207TX T6-T7-T8-T9-T10-T15-T20-T25-T27-T30-T40-T45
 1253

2,1 kg



MM210	1	024580210
MMV210	1	024590210

Beta

Beta

VPM0

soft thermoformed tray with tote tray

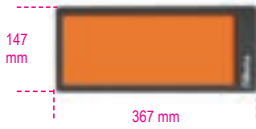

VPM0 1 088870350

VPM3

soft thermoformed tray with 4 tote trays

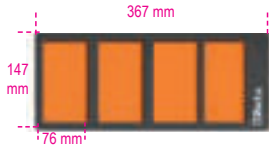

VPM3 1 088870353

VPM7

soft thermoformed tray with 3 tote trays

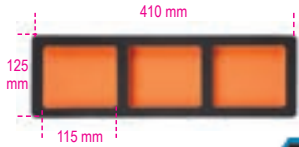

VPM7 1 088870356

VPM8

soft thermoformed tray with tote tray



VPM8 1 088870357

VPM9

soft thermoformed tray with tote tray



VPM9 1 088870358

VPM7-C

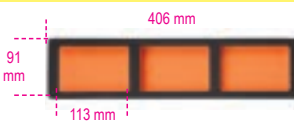

VPM7-C 1 088870360

Hard thermoformed trays T-series



Assortment of tools in thermoformed trays, designed for all roller cabs and all trolleys.

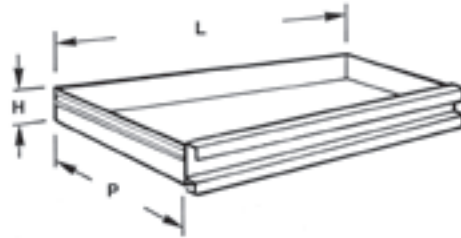

H mm 70
LxP mm 588x367

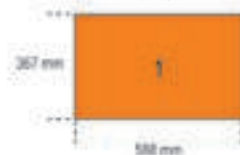
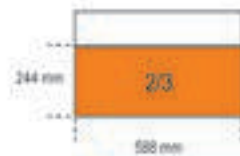
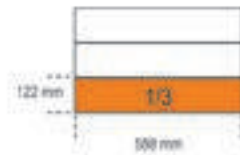
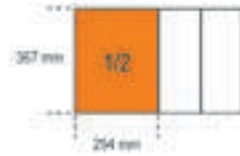
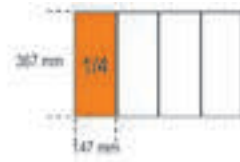

T10



42 6-7-8-10-11-12-13
14-16-17-18-19-21
22-24-27-30 mm



2,7 kg



T10 1 024240010
TV10 1 024000400

T13



42SLIM 8-10-11-12
13-14-15-16-17
18-19 mm



1,5 kg



T13 1 024240013
TV13 1 024249913

T15



42 6-7-8-9-10-11-12
13-14-15-16-17
18-19-20-21 mm



1,5 kg



T15 1 024240015
TV15 1 024000445

T16



42 22-24-27-30-32 mm



2,1 kg



T16 1 024240016
TV16 1 024000446

T18

16



42MP 6-7-8-9-10-11-12
13-14-15-16-17
18-19-20-21 mm

1,5 kg



T18 1 024240018
TV15 1 024000445

T19

5



42MP 22-24-27-30-32 mm

2,1 kg



T19 1 024240019
TV16 1 024000446

T22

15



42AS 5/16-3/8-7/16-1/2
9/16-5/8-11/16-3/4
3/32-1/8-5/32-3/16
1/4-5/16-3/8
96AS/BG7

1 kg



T22 1 024240022
TV20 1 024000488

T23

16



42INOX 8-10-11-12-13-14-15-
17-19 mm
96BPINOX 2,5-3-4-5-6-8-10 mm



1 kg



T23 1 024240023
TV23 1 024249906

T31

27



31 Ø 2-3-4-5-6 mm
32 Ø 4 mm
55 6x7-8x9-10x11
12x13-14x15
16x17-18x19
20x22-21x23
24x26-27x29
30x32 mm
96N/SC9 1,5+10 mm

3 kg



T31 1 024240031
TV30 1 024000401

T33

17



55 6x7-8x9-10x11
12x13-14x15
16x17-18x19
20x22 mm
96/SC9 1,5+10 mm

1 kg



T33 1 024240033
TV20 1 024000488

T34

17



55MP 6x7-8x9-10x11
12x13-14x15
16x17-18x19
20x22 mm
96/SC9 1,5+10 mm

1 kg



T34 1 024240034
TV20 1 024000488

T40

7



90 6x7-8x9-10x11
12x13-14x15
16x17-18x19 mm

810 g



T40 1 024240040
TV40 1 024000456

T41

5



90 20x22-21x23
24x26-25x28
27x29 mm

1,5 kg



T41 1 024240041
TV41 1 024000457

T45

12



142 8-9-10-11-12
13-14-15-16
17-18-19 mm

1,3 kg



T45 1 024240045
TV45 1 024000498

T46

12



142SN 8-9-10-11-12
13-14-15-16
17-18-19 mm

1,5 kg



T46 1 024240046
TV46 1 024000499

T48

12



96BPC/SC9 1,5+10 mm
142C 8-9-10-11-12
13-14-15-16
17-18-19 mm

1,4 kg



T48 1 024240048
TV47 1 024000763

T50

11



○ 96T

2-2,5-3-3,5-4-4,5
5-6-7-8-10 mm

1,3 kg



T50	1	024240050
TV50	1	024000764

T52

6



○ 96T

2-2,5-3-4-5-6 mm

350 g



T52	1	024240052
TV52	1	024000765

T53

5



○ 96TBP

2,5-3-4-5-6 mm

300 g



T53	1	024240053
TV52	1	024000765

T55

6



○ 97TTX

T10-T15-T20
T25-T27-T30

330 g



T55	1	024240055
TV55	1	024000766

T56

14



○ 96BP

○ 97TX

2-3-4-5-6-8-10 mm
T20-T25-T30-T40-
T45-T50-T55

300 g



T56	1	024240056
TV56	1	024249901

T57

5



○ 96TINOX

2,5-3-4-5-6 mm



350 g



T57	1	024240057
TV57	1	024249907

T59

14



- 111 250 mm
- 920/40 1/2
- 951 2,5-3-4-5-6-8 mm
- 953 4-5-6-8 mm
- 1370 300 - 500 g

4,7 kg



T59	1	024240059
TV60	1	024000420

T63

8



○ 952 7-8-10-12-13-14-17-19 mm

3,8 kg



T63	1	024240063
TV63	1	024000471

T64

8



○ 952FTX

E10-E12-E14

○ 953TX

T25-T27-T30-T40-T45

3,8 kg



T64	1	024240064
TV63	1	024000471

T65

8



○ 953

3-3,5-4-5-6-7-8-10 mm

2,8 kg



T65	1	024240065
TV63	1	024000471

T68

6



○ 951

2,5-3-4-5-6-8 mm

590 g



T68	1	024240068
TV68	1	024000470

T73

8



○ 930

6x7-8x9-10x11-12x13-
14x15-16x17-18x19-
20x22 mm

940/1

940/2

1,3 kg



T73	1	024240073
TV73	1	024000418

T75



○ 933 7-8-9-10-11-12-13
14-15-16-17-18-19
21-22-24 mm

4,2 kg



T75 1 024240075
TV75 1 024000422

T76



○ 932 7-8-9-10-11-12-13
14-15-16-17-18-19
21-22-24 mm

4,2 kg



T76 1 024240076
TV75 1 024000422

T77



○ 933 6-7-8-10-11-12-13
14-17-19 mm

1,4 kg



T77 1 024240077
TV77 1 024000474

T79



80 8x9-10x11-12x13
14x15-16x17
18x19 mm

1,3 kg



T79 1 024240079
TV79 1 024000490

T80



○ 920A 10-11-12-13-14
15-16-17-18-19
20-21-22-23-24
26-27-30-32 mm
○ 920ME 5-6-8-10-12 mm
920/21 125 mm
920/22 255 mm
920/25 305 mm
920/42 305 mm
Ⓢ 920/55

4,1 kg



T80 1 024240080
TV80 1 024000403

T81



○ 920B 10-11-12-13-14
15-16-17-18-19
20-21-22-23-24
26-27-30-32 mm
○ 920ME 5-6-8-10-12 mm
920/21 125 mm
920/22 255 mm
920/25 305 mm
920/42 305 mm
Ⓢ 920/55

4,1 kg



T81 1 024240081
TV80 1 024000403

T82



○ 920A 10-11-12-13-14
15-16-17-18-19
20-21-22-23-24
26-27-30-32 mm
○ 920ME 5-6-8-10-12 mm
920AN/125 125 mm
920AN/250 250 mm
920/25 305 mm
920/42 305 mm
Ⓢ 920/55

4,1 kg



T82 1 024240082
TV80 1 024000403

T83



○ 920A 10-11-12-13-14
15-16-17-18-19
20-21-22-23-24
26-27-30-32 mm
920/21 125 mm
920/22 255 mm
920/25 305 mm
920/42 305 mm
Ⓢ 920/55

3,6 kg



T83 1 024240083
TV83 1 024000402

T85



● 861LP 0,5x3 - 0,6x4,5 - 0,8x5,5 - 1x5,5 - 1,2x6,5 - 1,2x8 - 1,6x8 mm
○ 861PE 2 - 2,5 - 3 - 4 - 5 - 6 - 8 - 10 mm
⊕ 861PH PH0 - PH1 - PH2 - PH3
⊕ 861PZ PZ1 - PZ2 - PZ3
⊕ 861TX T6-T7-T8-T9-T10-T15-T20-T25-T27-T30-T40
⊕ 861RTX T9-T10-T15-T20-T25-T27-T30-T40
⊕ 861TRW 1-2-3-4-5-6 mm
⊕ 861TQS 0-1-2-3-4-5-6-8 mm
⊕ 861SP 4-6-8-10-12 mm
851SR 230 mm
○ 900 4-4,5-5-5,5-6-7-8-9
10-11-12-13-14 mm
900/21 150 mm
900/25 41 mm
900BG/30 176 mm
900/42 115 mm
Ⓢ 900/55 125 mm
194 1/4x5/16

1,0 kg



T85 1 024240085
TV85 1 024000747

T91



○ 900 4-4,5-5-5,5-6
7-8-9-10-11
12-13-14 mm
○ 900ME 2,5-3-4-5-6-8 mm
900/20 50 mm
900/21 150 mm
900/25 115 mm
900BG/30 115 mm
Ⓢ 900/55

560 g



T91 1 024240091
TV90 1 024000447

T92



○ 910A 6-7-8-9-10-11-12-13
14-15-16-17-18-19
20-21-22 mm
910/21 125 mm
910/22 250 mm
910/25 210 mm
910/42 210 mm
Ⓢ 910/55

1,5 kg



T92 1 024240092
TV92 1 024000458

T99

16



- 920INOX-A 10-12-13-14-15-16-17
18-19-21-22-24-27
30-32mm
- ⊗ 920/55INOX



2,7 kg

12"

T99	1	024240099
TV99	1	024249908

T100

16



- 920A 10-12-13-14-15
16-17-18-19-21
22-24 mm
- 920/21 125 mm
- 920/25 305 mm
- 920/42 305 mm
- ⊗ 920/55

2,1 kg

12"

T100	1	024240100
TV100	1	024000495

T101

16



- 920B 10-12-13-14-15
16-17-18-19-21
22-24 mm
- 920/21 125 mm
- 920/25 305 mm
- 920/42 305 mm
- ⊗ 920/55

2,1 kg

12"

T101	1	024240101
TV100	1	024000495

T102

16



- 920AS 3/8-7/16-1/2
9/16-5/8-11/16
3/4-13/16-7/8
15/16-1-1.1/16
- 920/21 125 mm
- 920/25 305 mm
- 920/42 305 mm
- ⊗ 920/55

2,1 kg

12"

T102	1	024240102
TV100	1	024000495

T103

17



- 900L 6-7-8-9-10-11-12 mm
- 920AL 13-14-16-17-18-19
21-22-24-27 mm

1,1 kg

14" 12"

C2

T103	1	024240103
TV103	1	024000748

T105

11



- 928A 22-24-27-30-32-34
36-38-41-46-50 mm

4,9 kg

3/4"

T105	1	024240105
TV105	1	024000484

T106

4



- 928/21 200 mm
- 928/22 380 mm
- 928/42 450 mm
- 928/55

4,5 kg

3/4"

T106	1	024240106
TV106	1	024000485

T110

14



- 720 10-11-12-13-14
16-17-18-19-21
22-23-24 mm
- 720/21 125 mm

1,8 kg

12"

T110	1	024240110
TV110	1	024000477

T112

32



- ⊗ 861TX ● 1/4-T6+T15
- ⊗ 866TX ● 5/16-T20+T55
- 895/1 ○ 1/4x□1/4
- 895/6 ○ 5/16x□1/2
- 900FTX □ 1/4-E4+E10
- 920FTX □ 1/2-E12+E24
- 920TX □ 1/2-T55L-T60-T70L

1,3 kg

14" 12"

T112	1	024240112
TV112	1	024000480

T113

12



- 920PE 5L-6L-7L-8L-10L
- 920TX T40L-T45L
T55L-T70L
- 920XZN M6L-M8L-M12L

1,5 kg

12"

T113	1	024240113
TV113	1	024000489

T121

1



- 666N/20 40 - 200 Nm

1,4 kg

12"

T121	1	024240121
TV121	1	024000767

T131

3



- ⊗ 1084BM 160 mm
- ≡ 1150BM 180 mm
- 1166BM 160 mm

750 g

T131	1	024240131
TV130	1	024000451

T132



- ◄ 1084 160 mm
- ≡ 1150 180 mm
- 1166 160 mm

650 g



T132 1 024240132
TV130 1 024000451

T142



- 1048 250 mm
- 1052 240 mm
- 1112 250 mm
- ≡ 1150 180 mm

1,8 kg



T142 1 024240142
TV143 1 024000409

T153



- 1048 250 mm
- 1052 240 mm

1,1 kg



T153 1 024240153
TV150 1 024000462

T135



- ◄ 1082MQ 160 mm
- ≡ 1150MQ 180 mm
- 1166MQ 160 mm

1000 V

750 g



T135 1 024240135
TV135 1 024000762

T145



- 1032 180 mm
- 1034 170 mm
- 1036 175 mm
- 1038 175 mm

640 g



T145 1 024240145
TV145 1 024000448

T154



- ◄ 1082 160 mm
- ≡ 1150 180 mm
- 1048 250 mm

1 kg



T154 1 024240154
TV148 1 024000500

T136



- 1048MQ 250 mm
- 1777MQ/U

700 g



T136 1 024240136
TV136 1 024000438

T146



- 1032 140x0,9 mm
- 1032 225 mm
- 1036 140x1,3 mm
- 1036 225 mm

700 g



T146 1 024240146
TV146 1 024000449

T155



- ◄ 1082BM 160 mm
- ≡ 1150BM 180 mm
- 1048BM 250 mm

1,1 kg



T155 1 024240155
TV148 1 024000500

T140



- 1032 140x0,9 - 180 mm
- 1034 170 mm
- 1036 140x1,3 - 175 mm
- 1038 175 mm
- ◄ 1084 160 mm
- 1128BM

1,1 kg



T140 1 024240140
TV140 1 024000405

T151



- 1047 240 mm
- 1057A 240 mm

1,3 kg



T151 1 024240151
TV150 1 024000462

T160



- 1290 3x75
- 3x100
- 4x100
- 4x150
- 5,5x100
- 5,5x150
- 6,5x150
- 8x150
- 10x200 mm
- 1290N 4x30
- 6,5x30 mm

1,3 kg



T160 1 024240160
TV160 1 024000706

T161



- 1292 PH0x60
PH0x100
PH1x80
PH1x120
PH2x100
PH2x150
PH3x150 mm
- 1292N PH1x30
PH2x30 mm

1 kg



T161	1	024240161
TV161	1	024000707

T164



- 952 8-10-13-17-19 mm
- 959 16 mm (5/8") - 20,8 mm (13/16")
- 1260 3x75-4x100-5,5x100
6,5x150-10x200 mm
- 1262 PH0x60-PH1x80
PH2x100-PH3x150 mm

5 kg



T164	1	024240164
TV61	1	024000721

T167



- 1260 3x75
3x100
4x100
4x150
5,5x100
5,5x150
6,5x150
8x150
10x200 mm
- 1260N 4x30
6,5x30 mm

1,3 kg



T167	1	024240167
TV160	1	024000706

T168



- 1262 PH0x60
PH0x100
PH1x80
PH1x120
PH2x100
PH2x150
PH3x150 mm
- 1262N PH1x30
PH2x30 mm

1 kg



T168	1	024240168
TV161	1	024000707

T170



- 1290 2,5x50
3x75
3,5x100
4x125
5,5x100
5,5x150
6,5x150 mm

450 g



T170	1	024240170
TV170	1	024000741

T171



- 1290 8x150
8x200
10x200 mm
- 1290N 4x30
6,5x30 mm

750 g



T171	1	024240171
TV171	1	024000742

T172



- 1292 PH0x60
PH0x100
PH1x80
PH1x120
PH2x100
PH2x150 mm

450 g



T172	1	024240172
TV172	1	024000743

T173



- 1292 PH3x150
PH4x200 mm
- 1292N PH1x30
PH2x30 mm

560 g



T173	1	024240173
TV173	1	024000744

T175



- 1297TX T6-T7-T8-T9
T10-T15-T20

410 g



T175	1	024240175
TV175	1	024000760

T176



- 1297TX T25-T27-T30
T40-T45

640 g



T176	1	024240176
TV176	1	024000766

T177



- 1298RTX T9-T10-T15
T20-T25-T27
T30-T40

680 g



T177	1	024240177
TV177	1	024000769

T180

Betamax



- 1290 3x75
4x100
5,5x150
6,5x150 mm
- ⊕ 1292 PH0x60
PH1x80
PH2x100 mm

480 g



T180 1 024240180
TV180 1 024000701

T183

Betamax



- ⊕ 1292L PH1x400-PH2x400 mm
- 1294L 3x300-4x400-5x400 mm

580 g



T183 1 024240183
TV183 1 024000497

T198



- 1260 3x75
4x100
5,5x150
6,5x150 mm
- ⊕ 1269PZ PZ0 - PZ1 - PZ2

490 g



T198 1 024240198
TV180 1 024000701

T199



- 1260 2,5x50
3x75
3,5x100
4x125
5,5x100
5,5x150
6,5x150 mm

490 g



T199 1 024240199
TV170 1 024000741

T201



- 1260 8x200
10x150
10x200 mm
- 1260N 4x30
6,5x30 mm

680 g



T201 1 024240201
TV171 1 024000742

T202



- ⊕ 1262 PH0x60
PH0x100
PH1x80
PH1x120
PH2x100
PH2x150 mm

490 g



T202 1 024240202
TV172 1 024000743

T204



- ⊕ 1262 PH3x150
PH4x200 mm
- ⊕ 1262N PH1x30
PH2x30 mm

610 g



T204 1 024240204
TV173 1 024000744

T205



- ⊕ 1267TX T6-T7-T8-T9
T10-T15-T20

460 g



T205 1 024240205
TV175 1 024000760

T206



- ⊕ 1267TX T25-T27-T30
T40-T45

710 g



T206 1 024240206
TV176 1 024000761

T207



- ⊕ 1268RTX T9-T10-T15
T20-T25-T27-T30

760 g



T207 1 024240207
TV207 1 024000758

T208



- 1260 3x75
4x100
5,5x150
6,5x150 mm
- ⊕ 1262 PH0x60
PH1x80
PH2x100 mm

530 g



T208 1 024240208
TV180 1 024000701

T209



- ⊕ 1262L PH1x400-PH2x400 mm
- 1264L 3x300-4x400-5x400 mm

580 g



T209 1 024240209
TV183 1 024000497

T210



- 1201 2,5x50
3x75
3,5x100
4x125
5,5x100
5,5x150
6,5x150 mm

490 g



T210	1	024240210
TV170	1	024000741

T212



- ⊕ 1202 PH0x60
PH1x80
PH1x120
PH2x100
PH2x150
PH3x150 mm

490 g



T212	1	024240212
TV212	1	024000440

T215



- 1207TX T6-T7-T8-T9
T10-T15-T20

410 g



T215	1	024240215
TV175	1	024000760

T220



- 1201 3x75
4x100
5,5x150
6,5x150 mm
- ⊕ 1202 PH0x60
PH1x80
PH2x100 mm

530 g



T220	1	024240220
TV180	1	024000701

T226

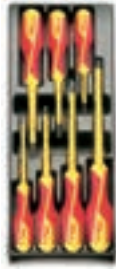

- 1274MQ 3x100
4x100
5,5x125
6,5x150 mm
- ⊕ 1272MQ PH0x60
PH1x80
PH2x100 mm

⚠ 1000 V

460 g



T226	1	024240226
TV180	1	024000701

T227



- 944BX 5-6-7-8-10-13 mm

490 g



T227	1	024240227
TV227	1	024000705

T228



- 1290INOX 3x75 - 4x100 -
5,5x150 - 6,5x150 mm
- ⊕ 1292INOX PH0x60 - PH1x80 -
PH2x100 mm



480 g

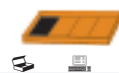

T228	1	024240228
TV180	1	024000701

T231



- 1370 400 g
- 1390 Ø 35 mm
- ▲ 1719BMA/T 200 mm
- 1719BMA/P 200 mm
- ▷ 1719BMA/M 200 mm

1,7 kg



T231	1	024240231
TV230	1	024000411

T233



- 35 100-200 mm
- 1370F 32 mm
- 1390 Ø 35 mm

1,3 kg



T233	1	024240233
TV232	1	024000452

T234



- 35 100-200 mm
- 1370 300 g
- 1390 Ø 35 mm

1,3 kg



T234	1	024240234
TV232	1	024000452

T236



- 1719BMA/Q 200 mm
- ▲ 1719BMA/T 200 mm
- 1719BMA/P 200 mm
- ▷ 1719BMA/M 200 mm
- 1719BMA/R 200 mm

870 g

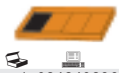

T236	1	024240236
TV235	1	024000453

T239



- 31BM Ø 2-3-4-5-6-8 mm
- 32 Ø 4 mm

850 g



T239	1	024240239
TV239	1	024000439

T241



1500N/1
1500N/3
1516/1

4,2 kg

T241 1 024240241
TV241 1 024000414

T250

Automotive



34 150 mm
83/S3 11x13-14x17
19x22 mm
1458 175 mm
1491
1603
1708/13 0,05±1 mm

1430 g

T250 1 024240250
TV250 1 024000408

T256

Automotive



○ 956E 16 mm (5/8) - 20,8 mm (13/16)
○ 956L 16 mm (5/8) - 20,8 mm (13/16)
959 16 mm (5/8) - 20,8 mm (13/16)
■ 1164 200 mm
1708/20 0,05±1 mm

3,2 kg

T256 1 024240256
TV255 1 024000467

Beta

T259



○ 96BP 2,5-3-4-5
6-8-10 mm
○ 96N 12 mm
● 860MIX/A31
○
⊕
⊕
⊕
895/1

950 g

T259 1 024240259
TV263 1 024000492

T264



1491 Ø 65±110 mm
■ 1494 ■ 10 mm
○ 1494E ○ 8-9-10-11-12-14-17 mm
○ 1494Q ○ 8-9,5-12-13 mm
△ 1494T △ 9,5
○ 1494XZN ○ 16
1496C ■ 8x ■ 10 mm

2,1 kg

T264 1 024240264
TV264 1 024000466

T270



430 M3 - 4 - 5 - 6 - 7 - 8 - 9
10 - 12 - 14 - 16 - 18 - 20
433 M6x0,75 - M8x1 - M10x1,25
M12x1,5 - M14x1,5
M16x1,5 - M18x1,5
440 M3 - 4 - 5 - 6 - 7 - 8 - 9
440A M10 - 12 - 14 - 16 - 18 - 20
441 M6x0,75 - M8x1,0
441A M10x1,25 - M12x1,5
M14x1,5 - M16x1,5
M18x1,5

4,3 kg

T270 1 024240270
TV270 1 024000481

T273



435/1,5 M3+M12
435/3 M5+M21
436/1 □ 2,0+5,0 mm
(M3+M8)
436/2 □ 4,6+8 mm
(M5+M12)
444/1 Ø 25,4 mm
444/2 Ø 38,1 mm
1707 W 62±4x1"

2,1 kg

T273 1 024240273
TV272 1 024000482

T281



1741B 250 mm
1741RV2,9K 2,9x6 mm (100)
1741RV3,2K 3,2x8 mm (100)
1741RV3,8K 3,8x10 mm (100)
1741RV4K 4x12 mm (100)

1,4 kg

T281 1 024240281
TV280 1 024000478

T285



1112 250 mm
1128BM -
1726 400 mm
1728BM (5)
1753 200 cc

1,5 kg

T285 1 024240285
TV285 1 024000487

Beta

Beta

T284

10



1128BMX	
1130BMX	
1719BMA...Q	200 mm
1719BMA...T	200 mm
1719BMA...P	200 mm
1719BMA...M	200 mm
1719BMA...R	200 mm
1726BM	400 mm
1728BM	
1771BM	170 mm
1778V18	185 mm

3,3 kg



T284	1	024240284
TV286	1	024249904

T289

4



1692	5 m
1725CR	-
1755	30 cc
1771	-

500 g



T289	1	024240289
TV290	1	024000455

T291

3



1479RB/1	
1479RB/2	
1479RB/3	

600 g

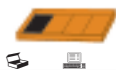

T291	1	024240291
TV291	1	024000472

T297

3



1651DGT	
1682	
1691BM	

490 g



T297	1	024240297
TV296	1	024000749

VP1 - VP2

thermoformed trays for small items, made from plastic for all roller cabs C22, C23, C23C

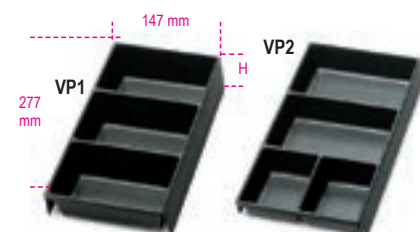

	H mm		
VP1	50	1	088880351
VP2	35	1	088880352

VP3 - VP4

thermoformed trays for small items, made from plastic for all roller cabs and all trolleys

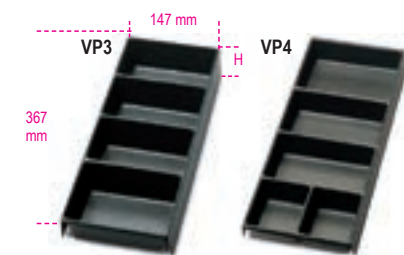

	H mm		
VP3	50	1	088880353
VP4	35	1	088880354

VP5

thermoformed tray



VP5	1	088880355
-----	---	-----------

VP6

thermoformed tray

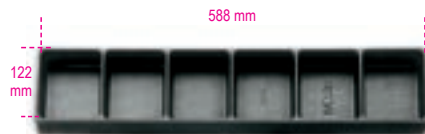

VP6	1	088880359
-----	---	-----------

VP-3SC

thermoformed tool trays, made from plastic, for mobile roller cab C38 +C04TSS-7

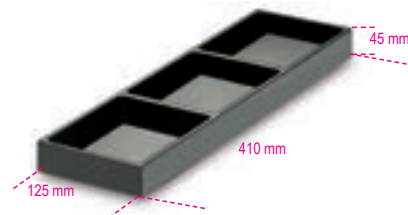

	H mm		
VP-3SC	45	1	088880356

VP-LS

thermoformed tool trays, made from plastic, for mobile roller cab C38 +C04TSS-7



	H mm		
VP-LS	45	1	088880357

VP-LD

thermoformed tool trays, made from plastic, for mobile roller cab C38



	H mm		
VP-LD	45	1	088880358

8889P1

parallel partitions for item C22S e C27S

drawer 588x257 mm



	h mm		
8889P1/5	50 mm	1	088890005
8889P1/7	70 mm	1	088890007

8889C1

crossed partitions for item C22S and C27S

for drawer 588x257 mm



	h		
8889C1/5	50 mm	1	088890015
8889C1/7	70 mm	1	088890017

8889P2

parallel partitions for standard drawer 588x367 mm



	h		
8889P2/7	70 mm	1	088890107

8889C2

crossed partitions for standard drawer 588x367 mm



	h		
8889C2	70 mm	1	088890117

8889P3

parallel partitions for item C24SA-XL

for drawer 882x367 mm



	h		
8889P3	70 mm	1	088890207

8889C3

crossed partitions for C24SA-XL

for drawer 882x367 mm



	h		
8889C3	70 mm	1	088890217

8889P4

parallel partitions for item C41

for drawer 418x205 mm



	h		
8889P4	70 mm	1	088890307

8889I4

crossed partition for item trolley C41

for drawer 418x205 mm



	h		
8889C4	70 mm	1	088890317

8889PS

parallel partitions for item C38 +C04TSS-7

left side drawer 570x410 mm



	h		
8889PS/7	70 mm	1	088890407

8889CS

crossed partitions for item C38 +C04TSS-7

left side drawer 570x410 mm



	h		
8889CS/7	70 mm	1	088890417

8889PD

parallel partitions for item C38 +C04TSS-7

right side drawer 313x410 mm



	h		
8889PD/7	70 mm	1	088890427

8889CD

crossed partitions for item C38 +C04TSS-7

right side drawer 313x410 mm



	h		
8889CD/7	70 mm	1	088890437

8889C6

crossed partitions for item C35

for drawer 600x447 mm



	h		
8889C6/7,5	75 mm	1	088890475
8889C6/10	100 mm	1	088890480
8889C6/15	150 mm	1	088890485
8889C6/20	200 mm	1	088890490

SB

socket rails



	L		
SB1	210 mm	10	088880201
SB2	280 mm	10	088880202
SB3	360 mm	10	088880203

MB

socket clips for rails SB



MB0	1/4	50	088880210
MB1	3/8	50	088880211
MB2	1/2	50	088880212

KIT/GPS

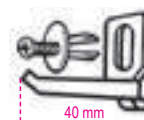

KIT/GPS	40 mm	50	088880119

VE1



VE1		20	088880120

GM



	∅		
GM	6,5 mm	5	088880250
	9,5 mm	5	088880251
	13 mm	5	088880252
	16 mm	5	088880253
	19 mm	5	088880254
	25 mm	5	088880255

S55/8

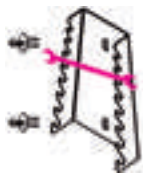

S55/8
55/S8
55AS/8
55MP/S8

1 088880420

S55/12

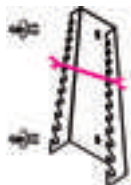

S55/12
55/S12
55/S12X
55AS/12
55MP/S12

1 088880421

ST2P



ST2P

1 088880422

TSPP

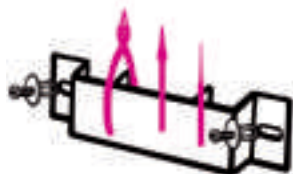

TSPP

1 088880402

S952/10

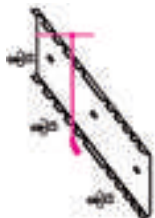

S952/10

1 088880423

Beta

S1719BM



S1719BM
1719BMA: Q-T-P-M-R
1719BMD: Q-T-P-M-R

1 088880404

SGN

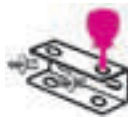

SGN
1290N-1292N-1299N/PZ
1260N-1262N-1269N/PZ
1201N-1202N-1209N/PZ

1 088880405

CB/2

only for C54

12"

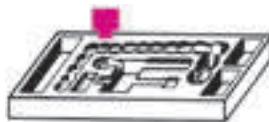

CB/2
920A/920B
10+24+26-27
28-30-32 mm
920/21-920/22-920/25-
920/42-920/55

1 088880411

S42/17



S42/17
42/S17
42MP/S17
42/S17X
42AS/17
142/S17

1 088880428

S951/6



S951/6
951/S6
951AS/S6X
951TX/S6

1 088880429

SPG11 - S1203/8



SPG11
n.8 Ø = 7 mm
n.2 Ø = 10 mm
n.1 Ø = 12 mm

1 088880910

S1203/8
1203/S8
1263/D8
1293/S8

1 088880430

S96T/8



S96T/8

1 088880431

96T/SPV

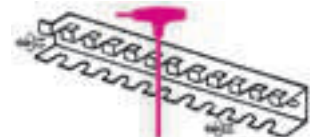

96T/SPV
96T/S11
97TTX/S11

1 000960958

Beta



Beta

CHEMICALS

Tightening a bolt is not always enough to guarantee secure tightening. Cleaning, lubrication and sealing are also necessary.

The range comprises anaerobic sealants, cyanoacrylate adhesives and aerosol cans for maintaining, cleaning and lubricating mechanical parts.

Anaerobic Products

Anaerobic products allow complete filling of small superficial irregularities in metal, so that mechanical stress can be distributed throughout the connecting surface. They harden in total absence of oxygen and completely seal joints or threads from water, gas, oil, fuel and industrial fluids.

They are available in three different strengths – high (H), medium (M) and low (L) – and in different packs, to satisfy different needs.

Instant Glue

Adhesive based on ethyl cyanoacrylate, for structural joints in a number of materials.

Aerosol Spray Cans

A wide range of products in spray cans, for use for unlocking, greasing, lubricating, cleaning and galvanizing purposes.

The spray cans are made of steel and are 100% recyclable.

ATTENTION!

Countries where the products of the Beta Chemicals range are allowed to be distributed: Austria, Belgium, France, Hungary, Italy, Netherlands, Poland, Portugal, Republic of Ireland, Spain, Switzerland, United Kingdom.



9803H

threadlocker-High Resistance

Ideal for permanent locking of parts that do not need subsequent dismantling, and for passivated metal surfaces, including brass, aluminium and stainless steel. Does not allow disassembly with hand tools.



Temperature range (°C)	-50/+150
Max gap fill (mm)	0,25
Handling cure time (minutes)	10/15
Functional cure time (h)	3-6
Viscosity (mPa.s) 25°C	800/1200
Breakaway torque ISO-10964	35-45 Nm
Prevailing torque ISO-10964	30-40 Nm

ml			
20	bottle	12	098030002
50	bottle	4	098030005
250	bottle	4	098030025

9802M

threadlocker-Medium Resistance

Ideal for fixing parts subject to periodic maintenance, bearings and bushes. Allows dismantling by using hand tools.



Temperature range (°C)	-50/+150
Max gap fill (mm)	0,15
Handling cure time (minutes)	10/15
Functional cure time (h)	3-6
Viscosity (mPa.s) 25°C	500/800
Breakaway torque ISO-10964	22-30 Nm
Prevailing torque ISO-10964	20-25 Nm

ml			
20	bottle	12	098020002
50	bottle	4	098020005
250	bottle	4	098020025



9801L

threadlocker-Low Resistance

Ideal for fixing particular light alloys which could get damaged during disassembly and for adjusting screws.
Easier parts disassembly.



Temperature range (°C)	-50/+150
Max gap fill (mm)	0,10
Handling cure time (minutes)	10/15
Functional cure time (h)	3-6
Viscosity (mPa.s) 25°C	500/800
Breakaway torque ISO-10964	6-10 Nm
Prevailing torque ISO-10964	4-8 Nm

ml			
20	bottle	12	098010002
50	bottle	4	098010005
250	bottle	4	098010025

9813H

thread sealant-High Resistance

Ideal for permanent sealing of nipples, that do not need subsequent dismantling, and for passivated metal surfaces, including brass, aluminium and stainless steel.
Does not allow disassembly with hand tools.



Temperature range (°C)	-50/+200
Max gap fill (mm)	0,15
Handling cure time (minutes)	10/15
Functional cure time (h)	3-6
Viscosity (mPa.s) 25°C	40.000/80.000
Breakaway torque ISO-10964	35-45 Nm
Prevailing torque ISO-10964	25-35 Nm

ml			
20	bottle	12	098130002
50	bellow bottle	6	098130305
50	tube	4	098130505
100	tube	4	098130510
250	tube	4	098130525



9812M

thread sealant-Medium Resistance

Ideal for sealing nipples parts subject to periodic maintenance.
Allows dismantling by using hand tools.



Temperature range (°C)	-50/+150
Max gap fill (mm)	0,35
Handling cure time (minutes)	12/18
Functional cure time (h)	3-6
Viscosity (mPa.s) 25°C	20.000/40.000
Breakaway torque ISO-10964	27-35 Nm
Prevailing torque ISO-10964	20-30 Nm

ml			
20	bottle	12	098120002
50	bellow bottle	6	098120305
50	tube	4	098120505
100	tube	4	098120510
250	tube	4	098120525

9811L

thread sealant-Low Resistance

Ideal for sealing small or fine-pitch joints.
Easier parts disassembly.



Temperature range (°C)	-50/+150
Max gap fill (mm)	0,20
Handling cure time (minutes)	10/15
Functional cure time (h)	3-6
Viscosity (mPa.s) 25°C	10.000/20.000
Breakaway torque ISO-10964	6-10 Nm
Prevailing torque ISO-10964	4-8 Nm

ml			
20	bottle	12	098110002
50	bellow bottle	6	098110305
50	tube	4	098110505
100	tube	4	098110510
250	tube	4	098110525

9823H

liquid gasket-High Resistance

Ideal for permanent sealing of surfaces.
Also ideal for reclaiming bearing housings and worn parts.
Does not allow disassembly with hand tools.



Temperature range (°C)	-50/+150
Max gap fill (mm)	0,35
Handling cure time (minutes)	10/16
Functional cure time (h)	3-6
Viscosity (mPa.s) 25°C	100.000/200.000
Breakaway torque ISO-10964	35-45 Nm
Prevailing torque ISO-10964	20-30 Nm

ml			
20	bottle	12	098230002
50	bellow bottle	6	098230305
50	tube	4	098230505
100	tube	4	098230510
250	tube	4	098230525

9822M

liquid gasket-Medium Resistance

Ideal for sealing of surfaces of parts subject to periodic maintenance.
Allows dismantling by using hand tools.



Temperature range (°C)	-50/+150
Max gap fill (mm)	0,35
Handling cure time (minutes)	10/15
Functional cure time (h)	3-6
Viscosity (mPa.s) 25°C	40.000/70.000
Breakaway torque ISO-10964	25-35 Nm
Prevailing torque ISO-10964	20-30 Nm

ml			
20	bottle	12	098220002
50	bellow bottle	6	098220305
50	tube	4	098220505
100	tube	4	098220510
250	tube	4	098220525



9821L

liquid gasket-Low Resistance

Ideal for sealing of surfaces of parts subject to frequent maintenance. Protects threads from corrosion and seizure from corrosion. Easier parts disassembly.



Temperature range (°C)	-50/+150
Max gap fill (mm)	0,35
Handling cure time (minutes)	20/30
Functional cure time (h)	3-6
Viscosity (mPa.s) 25°C	60.000/90.000
Breakaway torque ISO-10964	7-11 Nm
Prevailing torque ISO-10964	4-9 Nm

ml		
20 bottle	12	098210002
50 bellow bottle	6	098210305
50 tube	4	098210505
100 tube	4	098210510
250 tube	4	098210525

9833H

locker-High Resistance

Ideal for fixing parts that do not need subsequent dismantling. Also suitable for fixing already installed devices that are difficult to dismantle. Does not allow disassembly with hand tools.



Temperature range (°C)	-50/+180
Max gap fill (mm)	0,15
Handling cure time (minutes)	10/15
Functional cure time (h)	3-6
Viscosity (mPa.s) 25°C	400/700
Breakaway torque ISO-10964	35-45 Nm
Prevailing torque ISO-10964	30-40 Nm

ml		
20 bottle	12	098330002
50 bottle	4	098330005
250 bottle	4	098330025

9832M

locker-Medium Resistance

Ideal for fixing parts subject to periodic maintenance. Allows dismantling by using hand tools.



Temperature range (°C)	-50/+180
Max gap fill (mm)	0,25
Handling cure time (minutes)	12/20
Functional cure time (h)	3-6
Viscosity (mPa.s) 25°C	2000/4000
Breakaway torque ISO-10964	25-35 Nm
Prevailing torque ISO-10964	18-28 Nm

ml		
20 bottle	12	098320002
50 bottle	4	098320005
250 bottle	4	098320025

9831L

locker-Low Resistance

Ideal for fixing small parts subject to frequent maintenance. Easier parts disassembly.



Temperature range (°C)	-50/+150
Max gap fill (mm)	0,10
Handling cure time (minutes)	10/15
Functional cure time (h)	3-6
Viscosity (mPa.s) 25°C	500/800
Breakaway torque ISO-10964	6-10 Nm
Prevailing torque ISO-10964	4-8 Nm

ml		
20 bottle	12	098310002
50 bottle	4	098310005
250 bottle	4	098310025

9851

instant glue

Based on ethyl cyanoacrylate. For adhesion of a wide range of materials, including metal, plastics, leather, wood and several other types of substrates, whether combined with each other or separate; bonds quickly.



Temperature range (°C)	-55/+82
Viscosity (mPa.s) 25°C	80-120

g		
20 bottle	12	098510002
50 bottle	10	098510005
500 bottle	1	098510050

9710 - LUBRIBETA universal

7-in-1 multipurpose unlocking lubricant

1. Unlocking;
 2. Lubricating;
 3. Detergent, degreasing;
 4. Rust protective;
 5. Deoxidizing, for electrical contacts;
 6. Waterproof;
 7. Antifreezing.
- Silicone-free.



ml		
400	12	097100040
400	12	097101040

9712 - Ultra Sblock

unlocking lubricant, super-penetrating

Unlocking, deoxidizing, waterproof. Ideal for dissolving rust from nuts, bolts, screws and gears.



ml		
400	12	097120040
400	12	097121040

9720 - Multi Grease

multipurpose grease

Particularly useful for lubricating chains, gears and moving metal parts. Resistant to friction and weather. Highly adhesive. Does not drip.



ml			
400		12	097200040
400		12	097201040

9722 - Lithium Grease

white lithium grease

Based on grease with lithium, titanium and zinc oxide soaps. Ideal for lubricating gears, bearings and joints. Specific for marine applications. Highly resistant to water, sea salt, weather and high temperatures. Does not drip.



ml			
400		12	097220040
400		12	097221040

9724 - PTFE Grease

PTFE based grease

Particularly suitable for lubricating industrial chains and mechanical movements subject to heavy stress and low rotation speeds. Suitable for applications on plastics and rubber. Totally colourless. Waterproof and resistant to oxidation.



ml			
400		12	097240040
400		12	097241040

9726 - Copper Grease

copper grease

Suitable for lubricating joints, bolts, gears, driveshafts and other metal parts subject to high temperatures (up to 1,000 °C). Protective, anti-wear. Prevents oxidation. Does not drip.



ml			
400		12	097260040
400		12	097261040

9729 - Silic Spray

silicone spray

Suitable for lubricating plastic, rubber and metal parts. Protects from corrosion. Detaching. Antistatic. Waterproof. Can be used to polish wood, plastics and rubber. Solvent-free.



ml			
400		12	097290040
400		12	097291040

9740 - Brake Cleaner

brake cleaner

Ideal for cleaning brake discs and pads, engines. Removes grease and tar, without leaving residue. Evaporates quickly. Does not damage plastics and rubber.



ml			
500		12	097400050
500		12	097401050

9742 - Contact Cleaner

cleaner for electric and electronic contacts

Removes grease and dirt, without leaving oily residue. Evaporates quickly. Does not damage plastics and rubber.



ml			
400		12	097420040
400		12	097421040

9745 - Carb Cleaner

cleaner for carburettors and throttle bodies

Specific for interior and exterior cleaning of carburettors, suction ducts and throttle bodies. Totally removes carbonaceous residue, deposits and impurities. Does not leave oily residue.



ml			
400		12	097450040
400		12	097451040

9752 - Zinc 98%

clear zinc

Highly covering, it is ideal for galvanizing iron parts. Highly adhesive, it forms an elastic film of very light colour, similar to hot galvanizing. Particularly resistant to oxidation, abrasion and weather. Can be overpainted. Does not drip.



ml			
400		12	097520040
400		12	097521040



Beta ABRASIVES

A comprehensive range of rigid and flexible abrasives, comprising over 550 coded items manufactured in Italy, designed and developed to satisfy any industrial and professional material cutting and removal requirements.

Rigid abrasives

- Cutting discs
- Grinding discs
- Shaft-mounted wheels

Flexible abrasives

- Flap discs
- Shaft-mounted wheels
- Wheels with bores
- Wheels for satinizing machines
- Radial discs
- Fibre discs
- Anti-waste rolls

11001

abrasive steel cutting discs
with depressed centre



EN 12413

Ø mm	S mm	F mm		
76	3,2	10,00	25	110010076
100	2,5	15,88	10	110010102
100	3,2	15,88	10	110010103
115	2,5	22,23	10	110010117
115	3,2	22,23	10	110010118
125	2,5	22,23	10	110010127
125	3,2	22,23	10	110010128
150	2,5	22,23	10	110010152
150	3,2	22,23	10	110010153
180	2,5	22,23	10	110010182
180	3,2	22,23	10	110010183
230	2,5	22,23	10	110010232
230	3,2	22,23	10	110010233

11001H

HARD

Ø mm	S mm	F mm		
230	3,2	22,23	10	110010733

11003

abrasive steel cutting discs
with flat centre



EN 12413

Ø mm	S mm	F mm		
76	2,5	10,00	25	110030076
100	2,5	15,88	10	110030102
115	2,5	22,23	10	110030117
125	2,5	22,23	10	110030127
150	2,5	22,23	10	110030152
180	2,5	22,23	10	110030182
230	2,5	22,23	10	110030232

11011

abrasive steel grinding discs
with depressed centre



EN 12413

Ø mm	S mm	F mm		
76	6,5	10,00	25	110110076
100	6,5	15,88	10	110110100
115	6,5	22,23	10	110110115
125	6,5	22,23	10	110110125
150	6,5	22,23	10	110110150
180	6,5	22,23	10	110110180
230	6,5	22,23	10	110110230

11011H

HARD

Ø mm	S mm	F mm		
115	6,5	22,23	10	110110615
125	6,5	22,23	10	110110625
150	6,5	22,23	10	110110650
180	6,5	22,23	10	110110680
230	6,5	22,23	10	110110730

11018

abrasive ultra-thin steel cutting discs
with flat centre

60 m/s



EN 12413

Ø mm	S mm	F mm		
300	2,5	25,40	10	110180030
350	3,0	25,40	10	110180035
400	3,2	25,40	10	110180040

11019

80 m/s

Ø mm	S mm	F mm		
300	3,8	25,40	10	110190030
350	4,2	25,40	10	110190035
400	4,5	25,40	10	110190040

11021

abrasive steel and stainless steel cutting discs
with depressed centre



EN 12413

Ø mm	S mm	F mm		
76	3,2	10,00	25	110210076
100	2,5	15,88	10	110210102
100	3,2	15,88	10	110210103
115	2,5	22,23	10	110210117
115	3,2	22,23	10	110210118
125	2,5	22,23	10	110210127
125	3,2	22,23	10	110210128
150	2,5	22,23	10	110210152
150	3,2	22,23	10	110210153
180	2,5	22,23	10	110210182
180	3,2	22,23	10	110210183
230	2,5	22,23	10	110210232
230	3,2	22,23	10	110210233

11022

abrasive steel and stainless steel cutting discs
with flat centre



EN 12413

Ø mm	S mm	F mm		
76	2,5	10,00	25	110220076
100	2,5	15,88	10	110220100
115	2,5	22,23	10	110220115
125	2,5	22,23	10	110220125
150	2,5	22,23	10	110220150
180	2,5	22,23	10	110220180
230	2,5	22,23	10	110220230

11023

abrasive steel and stainless steel grinding discs
with depressed centre



EN 12413

Ø mm	S mm	F mm		
76	6,5	10,00	25	110230076
100	6,5	15,88	10	110230100
115	6,5	22,23	10	110230115
125	6,5	22,23	10	110230125
150	6,5	22,23	10	110230150
180	6,5	22,23	10	110230180
230	6,5	22,23	10	110230230

11024

abrasive steel and stainless steel cutting discs,
thin, with depressed centre

TOP LINE



EN 12413

Ø mm	S mm	F mm		
180	2,0	22,23	10	110240180
230	2,0	22,23	10	110240230

11031÷11038

abrasive steel and stainless steel cutting discs,
thin, with flat centre

TOP LINE

Ø 65 mm



EN 12413

Ø mm	S mm	F mm		
65	1,0	6,00	25	110310006
65	1,0	10,00	25	110310010
65	1,6	6,00	25	110310016
65	1,6	10,00	25	110310020

11032

Ø 76 mm

Ø mm	S mm	F mm		
76	1,0	6,00	25	110320006
76	1,0	10,00	25	110320010
76	1,6	6,00	25	110320016
76	1,6	10,00	25	110320020

11033

Ø 100 mm

Ø mm	S mm	F mm		
100	1,0	10,00	25	110330010
100	1,0	15,88	25	110330016
100	1,6	10,00	25	110330020
100	1,6	15,88	25	110330026

11034

Ø 115 mm

Ø mm	S mm	F mm		
115	1,0	22,23	25	110340022
115	1,2	22,23	25	110340042
115	1,6	22,23	25	110340062

11035

Ø 125 mm

Ø mm	S mm	F mm		
125	1,0	22,23	25	110350022
125	1,2	22,23	25	110350042
125	1,6	22,23	25	110350062

11036

Ø 150 mm

Ø mm	S mm	F mm		
150	1,6	22,23	10	110360022

11037

Ø 180 mm

Ø mm	S mm	F mm		
180	2,0	22,23	10	110370022

11038

Ø 230 mm

Ø mm	S mm	F mm		
230	2,0	22,23	10	110380022

11040

abrasive steel and stainless steel cutting discs, thin, with depressed centre

PREMIUM LINE



EN 12413

Ø mm	S mm	F mm		
180	2,0	22,23	10	110400018
230	2,0	22,23	10	110400230

11045

abrasive steel and stainless steel cutting discs, thin, with flat centre

PREMIUM LINE

Ø 115 mm



EN 12413

Ø mm	S mm	F mm		
115	1,0	22,23	25	110450010
115	1,2	22,23	25	110450012
115	1,6	22,23	25	110450016

11046

Ø 125 mm

Ø mm	S mm	F mm		
125	1,0	22,23	25	110460010
125	1,2	22,23	25	110460012
125	1,6	22,23	25	110460016

11047

Ø 150 mm

Ø mm	S mm	F mm		
150	1,6	22,23	10	110470016

11048

Ø 180 mm

Ø mm	S mm	F mm		
180	2,0	22,23	10	110480019

11049

Ø 230 mm

Ø mm	S mm	F mm		
230	2,0	22,23	10	110490019

11050

abrasive steel grinding discs, with zirconia abrasive and depressed centre



EN 12413

Ø mm	S mm	F mm		
115	6,5	22,23	10	110500115
125	6,5	22,23	10	110500125
150	6,5	22,23	10	110500150
180	7,0	22,23	10	110500180
230	7,0	22,23	10	110500230

11050S

SOFT

Ø mm	S mm	F mm		
230	7,0	22,23	10	110500430

11069

abrasive stone and marble cutting discs with depressed centre



EN 12413

Ø mm	S mm	F mm		
100	3,2	15,88	10	110690100
115	3,2	22,23	10	110690115
125	3,2	22,23	10	110690125
150	3,2	22,23	10	110690150
180	3,2	22,23	10	110690180
230	3,2	22,23	10	110690230

11100

abrasive shaft-mounted wheels, abrasive pink corundum grains, cylindrically shaped shaft Ø 3 x 37 mm



EN 12413

Ø mm	h mm		
3	6	25	111000003
4	8	25	111000004
5	10	25	111000005
6	10	25	111000006
6	13	25	111000007
8	12	25	111000008
10	4	25	111000010
10	10	25	111000011
10	12	25	111000012
12	15	25	111000013

11101

abrasive shaft-mounted wheels, abrasive pink corundum grains, cylindrically shaped shaft Ø 6 x 40 mm



EN 12413

Ø mm	h mm		
3	6	25	111010003
4	8	25	111010004
5	10	25	111010005
6	10	25	111010006
8	10	25	111010008
10	10	25	111010010
10	15	25	111010011
10	20	25	111010012
10	25	25	111010013
10	32	25	111010014
12	10	25	111010015
12	15	25	111010016
12	20	25	111010017
15	3	25	111010018
15	15	25	111010019
16	20	25	111010020
16	25	25	111010021
16	32	25	111010022
20	4	25	111010023
20	15	25	111010024
20	20	25	111010025
20	25	25	111010026
20	30	25	111010027
20	40	25	111010028
25	6	25	111010029
25	10	25	111010030
25	25	25	111010031
25	40	10	111010032
30	6	25	111010033
30	10	25	111010034
30	30	25	111010035
30	40	10	111010036
32	20	25	111010037
32	32	10	111010038
40	6	25	111010040
40	10	25	111010041
40	20	10	111010042
40	25	10	111010043
40	30	10	111010044
40	40	10	111010045
50	10	10	111010050
50	15	10	111010051
50	25	10	111010052
60	10	10	111010060

11102

abrasive shaft-mounted wheels,
abrasive pink corundum grains,
cylindrically shaped
shaft \varnothing 6 x 80 mm



EN 12413

Ø mm	h mm		
8	20	25	111020008
10	15	25	111020010
10	30	25	111020020
12	15	25	111020022
15	15	25	111020035
15	30	25	111020040
20	30	25	111020060

11105

abrasive shaft-mounted wheels,
abrasive pink corundum grains,
cylindrically/triangularly shaped
shaft \varnothing 6 x 40 mm

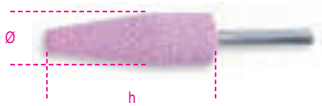

EN 12413

Ø mm	h mm		
20	65	25	111050020

11106

abrasive shaft-mounted wheels,
abrasive pink corundum grains,
trapezoidally shaped
shaft \varnothing 3 x 37 mm



EN 12413

Ø mm	h mm		
6	10	25	111060006

11107

abrasive shaft-mounted wheels,
abrasive pink corundum grains,
trapezoidally shaped
shaft \varnothing 6 x 40 mm



EN 12413

Ø mm	h mm		
12	20	25	111070012
15	25	25	111070015
20	30	25	111070020
25	40	10	111070025

11110

abrasive shaft-mounted wheels,
abrasive pink corundum grains,
rounded, cone-shaped
shaft \varnothing 3 x 37 mm



EN 12413

Ø mm	h mm		
10	15	25	111100010

11111

abrasive shaft-mounted wheels,
abrasive pink corundum grains,
rounded, cone-shaped
shaft \varnothing 6 x 40 mm



EN 12413

Ø mm	h mm		
10	20	25	111110010
15	30	25	111110015
16	45	25	111110016
20	28	25	111110020
20	40	25	111110021
25	70	10	111110025
30	50	10	111110030
32	32	10	111110032

11115

abrasive shaft-mounted wheels,
abrasive pink corundum grains,
ogive-shaped
shaft \varnothing 3 x 37 mm



EN 12413

Ø mm	h mm		
10	20	25	111150010

11116

abrasive shaft-mounted wheels,
abrasive pink corundum grains,
ogive-shaped
shaft \varnothing 6 x 40 mm

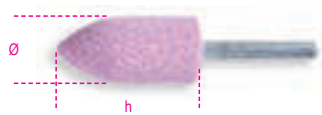

EN 12413

Ø mm	h mm		
10	20	25	111160010
18	30	25	111160018
20	50	25	111160020
21	45	25	111160021
22	70	10	111160022
30	50	10	111160030

11120

abrasive shaft-mounted wheels,
abrasive pink corundum grains,
cylindrically/pyramidally shaped
shaft \varnothing 3 x 37 mm



EN 12413

Ø mm	h mm		
6	13	25	111200006

11121

abrasive shaft-mounted wheels,
abrasive pink corundum grains,
cylindrically/pyramidally shaped
shaft \varnothing 6 x 40 mm



EN 12413

Ø mm	h mm		
6	25	25	111210007
12	20	25	111210012
20	25	25	111210020
25	25	25	111210025
30	30	25	111210030

11125

abrasive shaft-mounted wheels,
abrasive pink corundum grains,
rounded, cylindrically shaped
shaft \varnothing 6 x 40 mm



EN 12413

Ø mm	h mm		
6	20	25	111250006
25	25	25	111250025
30	50	10	111250030
40	40	10	111250040

11130

abrasive shaft-mounted wheels,
abrasive pink corundum grains,
globe-shaped
shaft \varnothing 3 x 37 mm



EN 12413

Ø mm	h mm		
6	6	25	111300006
8	8	25	111300008
10	10	25	111300010

11131

abrasive shaft-mounted wheels,
abrasive pink corundum grains,
globe-shaped
shaft $\varnothing 6 \times 40$ mm



EN 12413

Ø mm	h mm		
10	10	25	111310010
15	15	25	111310015
20	20	25	111310020
25	25	25	111310025
30	30	25	111310030

11132

abrasive shaft-mounted wheels,
abrasive pink corundum grains,
globe-shaped
shaft $\varnothing 6 \times 80$ mm



EN 12413

Ø mm	h mm		
10	10	25	111320010
15	15	25	111320015
20	20	25	111320020

11135

abrasive shaft-mounted wheels,
abrasive pink corundum grains,
disc-shaped
shaft $\varnothing 6 \times 40$ mm



EN 12413

Ø mm	h mm		
30	6	25	111350030
40	10	25	111350040

11140

abrasive shaft-mounted wheels,
abrasive grey/pink corundum grains,
cylindrically shaped
shaft $\varnothing 6 \times 40$ mm

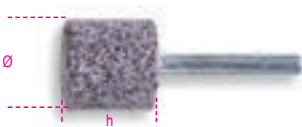

EN 12413

Ø mm	h mm		
20	30	25	111400020
20	40	25	111400021
25	25	25	111400025
30	30	25	111400030
30	40	10	111400031
50	10	10	111400050

11141

abrasive shaft-mounted wheels,
abrasive grey/pink corundum grains,
cylindrically shaped
shaft $\varnothing 6 \times 80$ mm



EN 12413

Ø mm	h mm		
20	40	25	111410020
30	40	10	111410030
40	40	10	111410040

11145

abrasive shaft-mounted wheels,
abrasive grey/pink corundum grains,
ogive-shaped
shaft $\varnothing 6 \times 40$ mm



EN 12413

Ø mm	h mm		
20	30	25	111450020
25	50	10	111450025

11150

abrasive shaft-mounted wheels,
abrasive grey/white corundum grains,
cylindrically shaped
shaft $\varnothing 6 \times 40$ mm



EN 12413

Ø mm	h mm		
15	30	25	111500015
20	30	25	111500020
30	30	25	111500030
50	10	10	111500050

11151

abrasive shaft-mounted wheels,
abrasive grey/white corundum grains,
cylindrically shaped
shaft $\varnothing 8 \times 40$ mm



EN 12413

Ø mm	h mm		
40	40	10	111510040

11155

abrasive shaft-mounted wheels,
abrasive grey/white corundum grains,
ogive-shaped
shaft $\varnothing 6 \times 40$ mm



EN 12413

Ø mm	h mm		
20	30	25	111550020
25	50	10	111550025

11200A

flap discs with zirconia abrasive cloth,
plastic backing pad, single flap construction

Flat
PREMIUM LINE
 $\varnothing 115$ mm



EN 13743

P	Ø mm	F mm		
40	115	22,23	10	112000004
60	115	22,23	10	112000006
80	115	22,23	10	112000008
120	115	22,23	10	112000012

11200B

$\varnothing 125$ mm

P	Ø mm	F mm		
40	125	22,23	10	112000104
60	125	22,23	10	112000106
80	125	22,23	10	112000108

11202A

flap discs with zirconia abrasive cloth,
plastic backing pad, double flap construction

Flat
PREMIUM LINE
 $\varnothing 115$ mm



EN 13743

P	Ø mm	F mm		
40	115	22,23	10	112020004
60	115	22,23	10	112020006
80	115	22,23	10	112020008
120	115	22,23	10	112020012

11202B

$\varnothing 125$ mm

P	Ø mm	F mm		
40	125	22,23	10	112020104
60	125	22,23	10	112020106
80	125	22,23	10	112020108

11202C

$\varnothing 180$ mm

P	Ø mm	F mm		
40	180	22,23	10	112020204
60	180	22,23	10	112020206

11204A

flap discs with zirconia abrasive cloth, fibreglass backing pad, single flap construction

Flat
PREMIUM LINE
Ø 115 mm



EN 13743

P	Ø mm	F mm		
40	115	22,23	10	112040004
60	115	22,23	10	112040006
80	115	22,23	10	112040008
120	115	22,23	10	112040012

11204B

Ø 125 mm

P	Ø mm	F mm		
40	125	22,23	10	112040104
60	125	22,23	10	112040106
80	125	22,23	10	112040108

11204C

Ø 180 mm

P	Ø mm	F mm		
40	180	22,23	10	112040204
60	180	22,23	10	112040206

11208A

flap discs with zirconia abrasive cloth, fibreglass backing pad, double flap construction

Flat
PREMIUM LINE
Ø 115 mm



EN 13743

P	Ø mm	F mm		
40	115	22,23	10	112080004
60	115	22,23	10	112080006

11208B

Ø 125 mm

P	Ø mm	F mm		
40	125	22,23	10	112080104
60	125	22,23	10	112080106

11210A

flap discs with zirconia abrasive cloth, fibreglass backing pad, single flap construction

Cone-shaped
PREMIUM LINE
Ø 115 mm



EN 13743

P	Ø mm	F mm		
40	115	22,23	10	112100004
60	115	22,23	10	112100006
80	115	22,23	10	112100008
120	115	22,23	10	112100012

11210B

Ø 125 mm

P	Ø mm	F mm		
40	125	22,23	10	112100104
60	125	22,23	10	112100106
80	125	22,23	10	112100108

11210C

Ø 180 mm

P	Ø mm	F mm		
40	180	22,23	10	112100204
60	180	22,23	10	112100206

11212A

flap discs with zirconia abrasive cloth, plastic backing pad, single flap construction

Flat
TOP LINE
Ø 115 mm



EN 13743

P	Ø mm	F mm		
40	115	22,23	10	112120004
60	115	22,23	10	112120006
80	115	22,23	10	112120008
120	115	22,23	10	112120012

11212B

Ø 125 mm

P	Ø mm	F mm		
40	125	22,23	10	112120104
60	125	22,23	10	112120106
80	125	22,23	10	112120108

11214A

flap discs with zirconia abrasive cloth, plastic backing pad, double flap construction

Flat
TOP LINE
Ø 115 mm



EN 13743

P	Ø mm	F mm		
40	115	22,23	10	112140004
60	115	22,23	10	112140006
80	115	22,23	10	112140008
120	115	22,23	10	112140012

11214B

Ø 125 mm

P	Ø mm	F mm		
40	125	22,23	10	112140104
60	125	22,23	10	112140106
80	125	22,23	10	112140108

11214C

Ø 180 mm

P	Ø mm	F mm		
40	180	22,23	10	112140204
60	180	22,23	10	112140206

11216A

flap discs with zirconia abrasive cloth, fibreglass backing pad, single flap construction

Flat
TOP LINE
Ø 115 mm



EN 13743

P	Ø mm	F mm		
40	115	22,23	10	112160004
60	115	22,23	10	112160006
80	115	22,23	10	112160008
120	115	22,23	10	112160012

11216B

Ø 125 mm

P	Ø mm	F mm		
40	125	22,23	10	112160104
60	125	22,23	10	112160106
80	125	22,23	10	112160108

11216C

Ø 180 mm

P	Ø mm	F mm		
40	180	22,23	10	112160204
60	180	22,23	10	112160206

11218A

flap discs with zirconia abrasive cloth, fibreglass backing pad, double flap construction

Flat
TOP LINE
Ø 115 mm



EN 13743

P	Ø mm	F mm		
40	115	22,23	10	112180004
60	115	22,23	10	112180006

11218B

Ø 125 mm

P	Ø mm	F mm		
40	125	22,23	10	112180104
60	125	22,23	10	112180106

11220A

flap discs with zirconia abrasive cloth, fibreglass backing pad, single flap construction

Cone-shaped
TOP LINE
Ø 115 mm



EN 13743

P	Ø mm	F mm		
40	115	22,23	10	112200004
60	115	22,23	10	112200006
80	115	22,23	10	112200008
120	115	22,23	10	112200012

11220B

Ø 125 mm

P	Ø mm	F mm		
40	125	22,23	10	112200104
60	125	22,23	10	112200106
80	125	22,23	10	112200108

11220C

Ø 180 mm

P	Ø mm	F mm		
40	180	22,23	10	112200204
60	180	22,23	10	112200206

11222

flap discs with zirconia abrasive cloth, fibreglass backing pad, double flap construction

Cone-shaped
TOP LINE
Ø 115 mm



EN 13743

P	Ø mm	F mm		
40	115	22,23	10	112220104
60	115	22,23	10	112220106
80	115	22,23	10	112220108

11230A

flap discs with corundum abrasive cloth, plastic backing pad, single flap construction

Flat
PREMIUM LINE
Ø 115 mm



EN 13743

P	Ø mm	F mm		
40	115	22,23	10	112300004
60	115	22,23	10	112300006
80	115	22,23	10	112300008
120	115	22,23	10	112300012

11230B

Ø 125 mm

P	Ø mm	F mm		
40	125	22,23	10	112300104
60	125	22,23	10	112300106

11230C

Ø 180 mm

P	Ø mm	F mm		
40	180	22,23	10	112300204
60	180	22,23	10	112300206

11232A

flap discs with corundum abrasive cloth, plastic backing pad, double flap construction

Flat
PREMIUM LINE
Ø 115 mm



EN 13743

P	Ø mm	F mm		
40	115	22,23	10	112320004
60	115	22,23	10	112320006
80	115	22,23	10	112320008
120	115	22,23	10	112320012

11232B

Ø 125 mm

P	Ø mm	F mm		
40	125	22,23	10	112320104
60	125	22,23	10	112320106

11234A

flap discs with corundum abrasive cloth, fibreglass backing pad, single flap construction

Flat
TOP LINE
Ø 115 mm



EN 13743

P	Ø mm	F mm		
40	115	22,23	10	112340004
60	115	22,23	10	112340006
80	115	22,23	10	112340008
120	115	22,23	10	112340012

11234B

Ø 125 mm

P	Ø mm	F mm		
40	125	22,23	10	112340104
60	125	22,23	10	112340106

11240A

flap discs with ceramic-coated zirconia abrasive cloth, plastic backing pad and single flap construction

Flat
Ø 115 mm



EN 13743

P	F mm		
40	22,23	10	112400004
60	22,23	10	112400006

11240B

Ø 125 mm

P	F mm		
40	22,23	10	112400104
60	22,23	10	112400106

11242A

flap discs with ceramic-coated zirconia abrasive cloth, fibreglass backing pad and single flap construction

Flat
Ø 115 mm



EN 13743

P	Ø mm	F mm		
40	115	22,23	10	112420004
60	115	22,23	10	112420006

11242B

Ø 125 mm

P	Ø mm	F mm		
40	125	22,23	10	112420104
60	125	22,23	10	112420106

11246A

flap discs with ceramic-coated abrasive cloth, plastic backing pad and single flap construction

Flat
Ø 115 mm



EN 13743

P	Ø mm	F mm		
40	115	22,23	10	112460004
60	115	22,23	10	112460006

11246B

Ø 125 mm

P	Ø mm	F mm		
40	125	22,23	10	112460104
60	125	22,23	10	112460106

11248A

flap discs with ceramic-coated abrasive cloth, fibreglass backing pad and single flap construction

Flat
Ø 115 mm



EN 13743

P	Ø mm	F mm		
40	115	22,23	10	112480004
60	115	22,23	10	112480006

11248B

Ø 125 mm

P	Ø mm	F mm		
40	125	22,23	10	112480104
60	125	22,23	10	112480106

11259

felt flap discs, fibreglass backing pad, single flap construction

Flat



Ø mm	F mm		
115	22,23	10	112590115
125	22,23	10	112590125

11260

shaft-mounted flap wheels, corundum abrasive cloth flaps
shaft Ø 3 mm

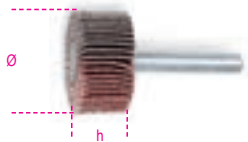

EN 13743

Ø mm	h mm	P		
10	10	60	10	112600010
15	15	60	10	112600015

11263

Ø 30 mm
shaft Ø 6 mm

Ø mm	h mm	P		
30	10	60	10	112630006
30	15	60	10	112630016
30	15	80	10	112630018
30	20	40	10	112630024
30	20	60	10	112630026
30	20	80	10	112630028
30	20	120	10	112630032

11264

Ø 40 mm
shaft Ø 6 mm

Ø mm	h mm	P		
40	15	60	10	112640006
40	15	80	10	112640008
40	15	120	10	112640012
40	20	40	10	112640014
40	20	60	10	112640016
40	30	40	10	112640024
40	30	60	10	112640026

11265

Ø 50 mm
shaft Ø 6 mm

Ø mm	h mm	P		
50	20	60	10	112650006
50	20	80	10	112650008
50	30	40	10	112650014
50	30	60	10	112650016
50	30	80	10	112650018
50	30	120	10	112650022

11266

Ø 60 mm
shaft Ø 6 mm

Ø mm	h mm	P		
60	20	40	10	112660004
60	20	60	10	112660006
60	30	40	10	112660014
60	30	60	10	112660016
60	30	80	10	112660018
60	30	120	10	112660022
60	40	60	10	112660026
60	40	80	10	112660028

11268

Ø 80 mm
shaft Ø 6 mm

Ø mm	h mm	P		
80	30	60	10	112680006
80	30	80	10	112680008
80	50	40	10	112680014
80	50	60	10	112680016
80	50	80	10	112680018
80	50	120	10	112680022

11271A

abrasive non-woven wheels, shaft-mounted, corundum synthetic fibre fabric

Ø 40 mm
shaft Ø 6 mm



Ø mm	h mm	P		
40	20	C	10	112710001
40	20	M	10	112710002
40	20	F	10	112710003
40	20	VF	10	112710004

11271B

Ø 60 mm
shaft Ø 6 mm

Ø mm	h mm	P		
60	30	C	10	112710011
60	30	M	10	112710012
60	30	F	10	112710013
60	30	VF	10	112710014

11271C

Ø 80 mm
shaft Ø 6 mm

Ø mm	h mm	P		
80	50	C	10	112710021
80	50	M	10	112710022
80	50	F	10	112710023
80	50	VF	10	112710024

11276A

flap/non-woven wheels, shaft-mounted, flaps made of abrasive cloth alternating with corundum synthetic fibre fabric

Ø 40 mm
shaft Ø 6 mm

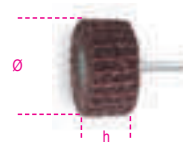

Ø mm	h mm	P		
40	20	M/60	10	112760006
40	20	M/80	10	112760008
40	20	M/120	10	112760012

11276B

Ø 60 mm
shaft Ø 6 mm

Ø mm	h mm	P		
60	30	M/60	10	112760016
60	30	M/80	10	112760018
60	30	M/120	10	112760022

11276C

Ø 80 mm
shaft Ø 6 mm

Ø mm	h mm	P		
80	50	M/60	10	112760036
80	50	M/80	10	112760038
80	50	M/120	10	112760042

11300A

flap wheels with corundum cloth, with bores

Ø 165 x 30 mm

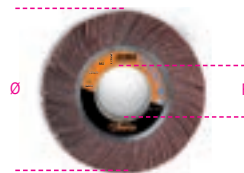

EN 13743

P	F mm		
40	54	3	113000004
60	54	3	113000006
80	54	3	113000008
120	54	3	113000012
180	54	3	113000018
220	54	3	113000022

11300B

Ø 165 x 50 mm

P	F mm		
40	54	2	113000104
60	54	2	113000106
80	54	2	113000108
120	54	2	113000112
180	54	2	113000118
220	54	2	113000122

11300C

Ø 200 x 30 mm

P	F mm		
40	54	3	113000204
60	54	3	113000206
80	54	3	113000208
120	54	3	113000212
180	54	3	113000218

11300D

Ø 200 x 50 mm

P	F mm		
40	54	2	113000304
60	54	2	113000306
80	54	2	113000308
120	54	2	113000312
180	54	2	113000318
220	54	2	113000322

11300E

Ø 250 x 30 mm

P	F mm		
40	100	3	113000404
60	100	3	113000406
80	100	3	113000408
120	100	3	113000412

11300F

Ø 250 x 50 mm

P	F mm		
40	100	2	113000504
60	100	2	113000506
80	100	2	113000508
120	100	2	113000512
180	100	2	113000518
220	100	2	113000522

11300G

Ø 300 x 50 mm

P	F mm		
40	100	2	113000604
60	100	2	113000606
80	100	2	113000608

11310A

flap wheels with corundum cloth, with bores, slashed flaps

Ø 165 x 30 mm



EN 13743

P	F mm		
60	54	3	113100006
80	54	3	113100008

11310B

Ø 165 x 50 mm

P	F mm		
60	54	2	113100106
80	54	2	113100108

11310C

Ø 200 x 30 mm

P	F mm		
60	54	3	113100206
80	54	3	113100208

11310D

Ø 200 x 50 mm

P	F mm		
60	54	2	113100306
80	54	2	113100308

11310E

Ø 250 x 30 mm

P	F mm		
60	100	3	113100406
80	100	3	113100408

11310F

Ø 250 x 50 mm

P	F mm		
60	100	2	113100506
80	100	2	113100508

11310G

Ø 300 x 50 mm

P	F mm		
60	100	2	113100606
80	100	2	113100608

11320

abrasive non-woven wheels with bores, corundum synthetic fibre fabric

Ø 200 x 50 mm



P	F mm		
C	76,2	2	113200006
M	76,2	2	113200008
F	76,2	2	113200012
VF	76,2	2	113200024

11411

flap wheels with corundum cloth for satinizing machines

Ø 100 x 100 mm



EN 13743

P	F mm		
40	19,1	2	114110004
60	19,1	2	114110006
80	19,1	2	114110008
120	19,1	2	114110012
240	19,1	2	114110024

11415A

non-woven flaps with corundum synthetic fibres for satinizing machines

Ø 100 x 50 mm



P	F mm		
C	19,1	4	114150006
M	19,1	4	114150008
F	19,1	4	114150012
VF	19,1	4	114150024

11415B

non-woven flaps with corundum synthetic fibres for satinizing machines

Ø 100 x 100 mm



P	F mm		
C	19,1	2	114150106
M	19,1	2	114150108
F	19,1	2	114150112
VF	19,1	2	114150124

11420A

flap/non-woven wheels for satinizing machines, abrasive cloth alternating with corundum synthetic fibres

Ø 100 x 50 mm



P	F mm		
C	19,1	4	114200006
M	19,1	4	114200008
F	19,1	4	114200012
VF	19,1	4	114200024

11420B

flap/non-woven wheels for satinizing machines, abrasive cloth alternating with corundum synthetic fibres

Ø 100 x 100 mm

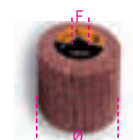

P	F mm		
C	19,1	2	114200106
M	19,1	2	114200108
F	19,1	2	114200112
VF	19,1	2	114200124

11431

non-woven radial discs,
corundum synthetic fibres
Ø 115 mm

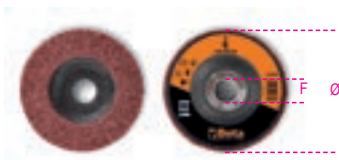

P	F mm		
C	22,23	4	114310006
M	22,23	4	114310008
F	22,23	4	114310012
VF	22,23	4	114310024

11435

flap/non-woven radial discs,
abrasive cloth alternating with corundum
synthetic fibres
Ø 115 mm



P	F mm		
M/80	22,23	4	114350008
M/120	22,23	4	114350012
F/150	22,23	4	114350015
F/180	22,23	4	114350018

11440A

fibre discs with zirconia cloth
Ø 115 mm

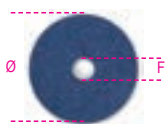

P	Ø mm	F mm		
24	115	22	25	114400024
36	115	22	25	114400036
60	115	22	25	114400060
120	115	22	25	114400120

11440B

Ø 125 mm

P	Ø mm	F mm		
24	125	22	25	114400224
36	125	22	25	114400236
60	125	22	25	114400260
120	125	22	25	114400320

11440C

Ø 180 mm

P	Ø mm	F mm		
24	180	22	25	114400424
36	180	22	25	114400436
60	180	22	25	114400460
120	180	22	25	114400520

11450A

fibre discs with corundum cloth
Ø 115 mm

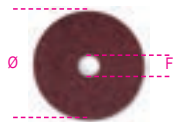

P	Ø mm	F mm		
24	115	22	25	114500024
36	115	22	25	114500036
60	115	22	25	114500060
120	115	22	25	114500120

11450B

Ø 125 mm

P	Ø mm	F mm		
24	125	22	25	114500224
36	125	22	25	114500236
60	125	22	25	114500260
120	125	22	25	114500320

11450C

Ø 180 mm

P	Ø mm	F mm		
24	180	22	25	114500424
36	180	22	25	114500436
60	180	22	25	114500460
120	180	22	25	114500520

11480

fibre discs with silicon carbide cloth
Ø 180 mm



P	Ø mm	F mm		
120	180	22	25	114800012
220	180	22	25	114800022
320	180	22	25	114800032

11491

anti-waste rolls made of corundum abrasive
cloth
h 38 mm x 50 m



P		
40	1	114910004
60	1	114910006
80	1	114910008
100	1	114910010
120	1	114910012
150	1	114910015
180	1	114910018
220	1	114910022
240	1	114910024
320	1	114910032
400	1	114910040

11493

anti-waste rolls made of corundum abrasive
cloth
h 50 mm x 50 m



P		
40	1	114930004
60	1	114930006
80	1	114930008
100	1	114930010
120	1	114930012
150	1	114930015
180	1	114930018
220	1	114930022
240	1	114930024
320	1	114930032
400	1	114930040

11495

anti-waste rolls made of corundum abrasive
cloth
h 120 mm x 25 m



P		
40	1	114950004
60	1	114950006
80	1	114950008
100	1	114950010
120	1	114950012
180	1	114950018
240	1	114950024
400	1	114950040

11496

anti-waste mini rolls made of corundum
abrasive paper
h 120 mm x 5 m



P		
40	12	114960004
60	12	114960006
80	12	114960008
100	12	114960010
120	12	114960012
180	12	114960018
240	12	114960024
320	12	114960032

11498

non-woven anti-waste roll
with corundum synthetic fibres
h 100 mm x 10 m



P		
M	1	114980008
F	1	114980012
VF	1	114980015
UF	1	114980018



**PRODUCTS UNDER THE BRAND NAME BM:
CABLE TIES, TERMINAL BLOCKS,
ELECTRICAL TAPES**

BM Group has been designing, manufacturing and distributing connecting parts and electrical installation products since 1958. Quality, safety and reliability have always been BM's key values. Combined with a passion for excellence, these values have allowed the company to develop – step by step – into a benchmark for the electrical material market. In 2018 BM Group was taken over by Beta Utensili. This section comprises an accurate selection of products under the brand name BM, supplementing Beta's product range.

CERTIFIED QUALITY



1610-B

pre-insulated ring terminals

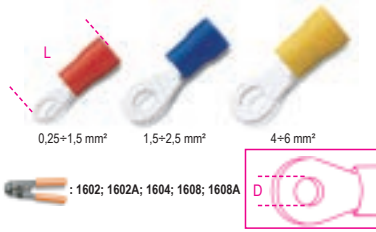

D mm	mm ²	L mm		
4	0,25-1,5	20,6	100	BM00119
5	0,25-1,5	21,8	100	BM00125
5	1,5-2,5	22,4	100	BM00225
6	1,5-2,5	26	100	BM00231
8	1,5-2,5	29,8	100	BM00237
6	4-6	29,1	50	BM00331
8	4-6	34,5	50	BM00337

- Please indicate number of terminals, and not of packages, in your order

1614-P

pre-insulated ferrule terminals

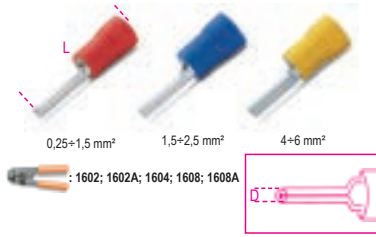

D mm	mm ²	L mm		
1,8	0,25-1,5	20	100	BM00151
1,8	1,5-2,5	20	100	BM00251
2,6	4-6	28	50	BM00350

- Please indicate number of terminals, and not of packages, in your order

1616-SM

pre-insulated male pin terminals

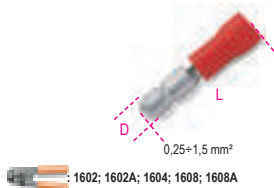

D mm	mm ²	L mm		
4	0,25-1,5	21	100	BM00130

- Please indicate number of terminals, and not of packages, in your order

1618-SF

pre-insulated female pin terminals

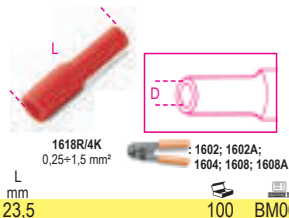

D mm	mm ²	L mm		
4	0,25-1,5	23,5	100	BM00140

- Please indicate number of terminals, and not of packages, in your order

1620-M

pre-insulated quick male terminals

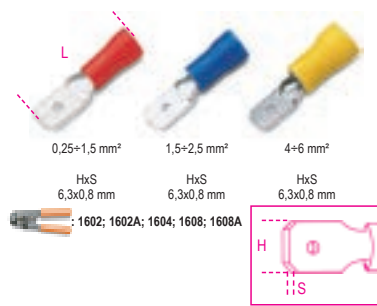

HxS mm	mm ²	L mm		
6,3x0,8	0,25-1,5	21	100	BM00180
6,3x0,8	1,5-2,5	21	100	BM00280
6,3x0,8	4-6	24,5	50	BM00380

- Please indicate number of terminals, and not of packages, in your order

1622-F

pre-insulated quick female terminals

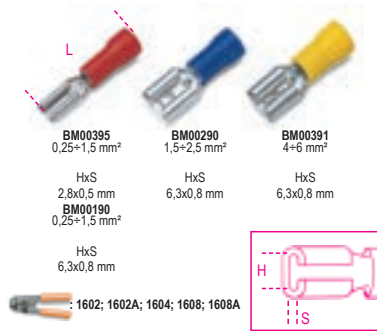

HxS mm	mm ²	L mm		
6,3x0,8	0,25-1,5	20,7	100	BM00190
6,3x0,8	1,5-2,5	20,7	100	BM00290
6,3x0,8	4-6	24,5	50	BM00391
2,8x0,5	0,25-1,5	18,5	100	BM00395

- Please indicate number of terminals, and not of packages, in your order

1624-FI

insulated quick female terminals

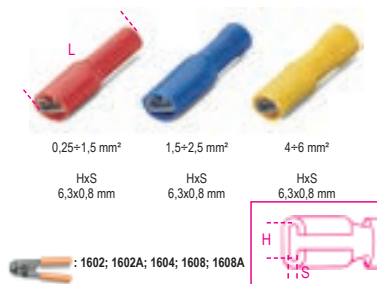

HxS mm	mm ²	L mm		
6,3x0,8	0,25-1,5	22	100	BM00191
6,3x0,8	1,5-2,5	22	50	BM00291
6,3x0,8	4-6	25	50	BM00392

- Please indicate number of terminals, and not of packages, in your order

1628-C

pre-insulated cable connectors

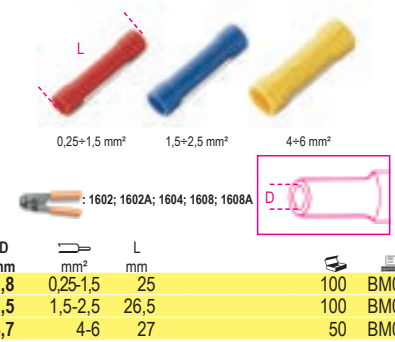

D mm	mm ²	L mm		
1,8	0,25-1,5	25	100	BM00160
2,5	1,5-2,5	26,5	100	BM00260
3,7	4-6	27	50	BM00360

- Please indicate number of terminals, and not of packages, in your order

1630-CR

quick connectors

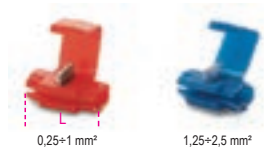

mm ²	L mm		
0,25-1	15,3	500	BM00110
1,25-2,5	15,9	500	BM00210

- Please indicate number of terminals, and not of packages, in your order

1632-TS

single tube terminals

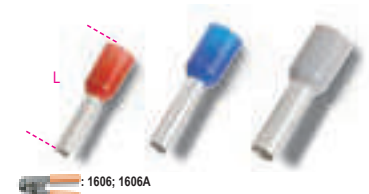

mm ²	L mm		
0,5	14	500	BM00601
0,75	14	500	BM00602
1	14	500	BM00603
1,5	14	500	BM00604
2,5	14	250	BM00506
4	17	200	BM00508
6	20	100	BM00610

- Please indicate number of terminals, and not of packages, in your order

1634-TD

dual tube terminals



mm ²	L mm		
0,5	15	200	BM00651
0,75	15	200	BM00652
1	15	200	BM00654
1,5	16	200	BM00656
2,5	18,5	100	BM00558
4	23	100	BM00560
6	26	50	BM00661

- Please indicate number of terminals, and not of packages, in your order





1635-S

closed end connector terminals, for free connections

Insulating housing: transparent polycarbonate UL94 V0
 Conductive body: brass
 Captive screw: galvanized steel
 Self-extinguishing: EN60695-2-10 a 850°C, EN 60335-1:2002 +A2:2006, EN60695-2-11
 Working temperature: max. 85 °C
 Degree of protection: IP20
 Reference standards: EN60998-1: EN60998-2-1:2004



N x mm ²			
2 x 1.5	10		BM991
2 x 2.5	10		BM992
3 X 1.5			
3 x 2.5	10		BM9924
4 x 1.5			
4 x 2.5	10		BM993
2 x 6	10		BM994
3 x 6	10		BM995

1635-S



N x mm ²			
2 x 25	25		BM9960
3 x 16			
4 x 10			
2 x 35	25		BM9961
2 x 25			
3 x 16			



1748-BV2

nylon cable ties,
 natural colour

Material: polyamide PA 6.6
 Self-extinguishing class: UL 94-V2
 Working temperature: -40 °C + 85 °C
 Minimum installation temperature: -10 °C
 Resistance to chemicals: Good resistance to bases, oils, greases, chloride solvents. Limited resistance to acids. Not resistant to phenols
 Reference standards: EN 62275:2015-02
 Classification: type 1 (EN); type 21 (UL)

CE

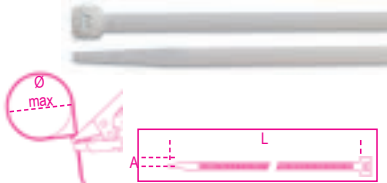

A mm	L mm	Ø MAX mm	F MAX N		
2.5	80	14	80	100	BMB0824
2.5	100	20.5	80	100	BMB1025
2.5	120	27	80	100	BMB1225
2.5	160	40	80	100	BMB1625
2.5	200	52	80	100	BMB2025
3.6	140	33	180	100	BMB1436
3.6	200	52	180	100	BMB2036
3.6	300	106	180	100	BMB2936
3.6	370	105	180	100	BMB3736

A mm	L mm	Ø MAX mm	F MAX N		
4.6	120	24	220	100	BMB1248
4.6	160	36	220	100	BMB1648
4.8	188	46	220	100	BMB1948
4.8	200	50	220	100	BMB2048
4.8	250	81	220	100	BMB2548
4.8	300	81	220	100	BMB3048
4.8	370	103	220	100	BMB3748
4.8	390	110	220	100	BMB3948
4.8	430	122	220	100	BMB4348
4.8	530	160	220	100	BMB5348
7.6	150	24	550	100	BMB1576
7.6	200	51	550	100	BMB2076
7.6	300	83	550	100	BMB2976
7.6	370	103	550	100	BMB3776
7.6	450	130	550	100	BMB4576
7.6	540	159	550	100	BMB5476
7.6	750	226	550	100	BMB7576
8.8	550	163	800	100	BMB5390
8.8	710	195	800	100	BMB7190
8.8	780	235	800	100	BMB7890
9	430	130	800	100	BMB4390
9	810	245	800	100	BMB8190
9	1020	295	800	100	BMB1090
9	1220	375	800	100	BMB1290
9	1530	460	800	100	BMB1590

- Please indicate number of cable ties, and not of packages, in your order

1748N

nylon cable ties,
 black

UV resistant

Material: polyamide PA 6.6 + carbon black
 Self-extinguishing class: UL 94-V2
 Working temperature: -40 °C + 85 °C
 Minimum installation temperature: -10 °C
 Resistance to chemicals: Good resistance to bases, oils, greases, chloride solvents. Limited resistance to acids. Not resistant to phenols
 Reference standards: EN 62275:2015-02
 Classification: type 1 (EN)

CE

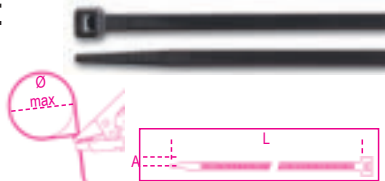

A mm	L mm	Ø mm	F MAX N		
2.5	80	14	80	100	BMN0824
2.5	100	20	80	100	BMN1025
2.5	120	27	80	100	BMN1225
2.5	160	40	80	100	BMN1625
2.5	200	52	80	100	BMN2025
3.6	140	33	180	100	BMN1436
3.6	200	52	180	100	BMN2036
3.6	300	106	180	100	BMN2936
3.6	370	105	180	100	BMN3736
4.6	120	24	220	100	BMN1248
4.6	160	36	220	100	BMN1648
4.8	188	46	220	100	BMN1948
4.8	200	50	220	100	BMN2048
4.8	250	81	220	100	BMN2548
4.8	300	81	220	100	BMN3048
4.8	370	103	220	100	BMN3748
4.8	390	110	220	100	BMN3948
4.8	430	122	220	100	BMN4348
4.8	530	160	220	100	BMN5348
7.6	150	24	550	100	BMN1576
7.6	200	51	550	100	BMN2076
7.6	300	83	550	100	BMN2976
7.6	370	103	550	100	BMN3776
7.6	450	130	550	100	BMN4576
7.6	540	159	550	100	BMN5476
7.6	750	226	550	100	BMN7576
8.8	550	163	800	100	BMN5390
8.8	710	195	800	100	BMN7190
8.8	780	235	800	100	BMN7890
9	430	130	800	100	BMN4390
9.0	810	245	800	100	BMN8190
9	1020	295	800	100	BMN1090
9	1220	375	800	100	BMN1290
9	1530	460	800	100	BMN1590

- Please indicate number of cable ties, and not of packages, in your order

1748-UL

nylon cable ties,
 black,

UV resistant

Material: polyamide PA 6.6 + carbon black
 Self-extinguishing class: UL 94-V2
 Working temperature: -40 °C + 85 °C
 Minimum installation temperature: -10 °C
 Resistance to chemicals: Good resistance to bases, oils, greases, chloride solvents. Limited resistance to acids. Not resistant to phenols
 Reference standards: EN 62275:2015-02
 Classification: type 1 (EN); type 21 (UL)

CE

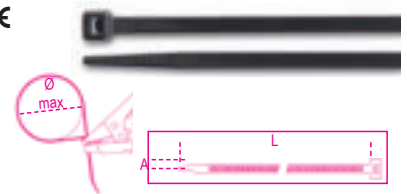

A mm	L mm	Ø MAX mm	F MAX N		
12.4	230	57	1200	100	BMN2412
12.4	480	136	1200	100	BMN4912
12.4	730	216	1200	100	BMN7412
12.4	880	263	1200	100	BMN8912
12.4	1000	305	1200	100	BMN1012

- Please indicate number of cable ties, and not of packages, in your order

1748-N2D

nylon cable ties,
 black,

UV resistant

Material: polyamide PA 6.6 + carbon black
 Self-extinguishing class: UL 94-V2
 Working temperature: -40 °C + 85 °C
 Minimum installation temperature: -10 °C
 Resistance to chemicals: Good resistance to bases, oils, greases, chloride solvents. Limited resistance to acids. Not resistant to phenols
 Reference standards: EN 62275:2015-02
 Classification: type 1 (EN)

CE



A mm	L mm	Ø MAX mm	F MAX N		
9	180	40	400	100	BMN1890
9	265	62	540	100	BMN2690
9	360	93	540	100	BMN3690

- Please indicate number of cable ties, and not of packages, in your order



1748-BV0

self-extinguishing nylon cable ties,
white

Material: polyamide PA 6.6

Self-extinguishing class: UL 94-V0

Working temperature: -40 °C ÷ +85 °C

Minimum installation temperature: -10 °C

Resistance to chemicals: Good

resistance to bases, oils, greases, chloride solvents. Limited resistance to acids. Not resistant to phenols

Reference standards: EN 62275:2015-02

Classification: type 1 (EN)

CE



A	L	Ø MAX	F MAX		
mm	mm	mm	N		
2.5	100	20	80	100	BMB1025V0
3.6	150	36	180	100	BMB1536V0
3.6	200	52	180	100	BMB2036V0
4.8	200	49	230	100	BMB2048V0
4.8	300	81	230	100	BMB3048V0
4.8	380	106	230	100	BMB3848V0
7.6	380	106	540	100	BMB3876V0

Please indicate number of cable ties, and not of packages, in your order

1748-BX

nylon cable ties,
blue,
detectable by metal detectors

Material: polyamide PA 6.6 + metal powder

Self-extinguishing class: UL 94-V2

Working temperature: -40 °C ÷ +85 °C

Minimum installation temperature: -10 °C

Resistance to chemicals: Good resistance to bases, oils, greases, chloride solvents. Limited resistance to acids. Not resistant to phenols

Reference standards: EN 62275:2015-02

Classification: type 1 (EN)

CE



A	L	Ø MAX	F MAX		
mm	mm	mm	N		
2.5	100	20	80	100	BMBX1025
3.6	150	36	180	100	BMBX1536
3.6	200	52	180	100	BMBX2036
4.8	200	49	230	100	BMBX2048
4.8	300	81	230	100	BMBX3048
4.8	380	106	230	100	BMBX3848
7.6	380	106	540	100	BMBX3876

Please indicate number of cable ties, and not of packages, in your order

Beta

1748-BL

steel tooth nylon cable ties,
natural colour

Material: polyamide PA 6.6 + steel

Self-extinguishing class: UL 94-V2

Working temperature: -40 °C ÷ +85 °C

Minimum installation temperature: -10 °C

Resistance to chemicals: Good resistance to bases, oils, greases, chloride solvents. Limited resistance to acids. Not resistant to phenols

Reference standards: EN 62275:2015-02

Classification: type 1 (EN)

CE

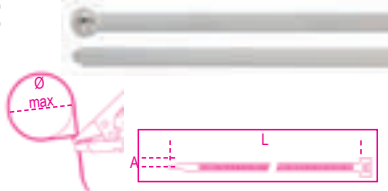

A	L	Ø MAX	F MAX		
mm	mm	mm	N		
2.5	100	20	180	100	BMBL1025
3.6	140	33	250	100	BMBL1436
2.5	200	52	180	100	BMBL2025
4.8	200	49	360	100	BMBL2048
4.8	300	81	360	100	BMBL3048
4.8	370	103	360	100	BMBL3748
7.6	370	103	780	100	BMBL3776

Please indicate number of cable ties, and not of packages, in your order

1748-NL

steel tooth nylon cable ties,
black,
UV resistant

Material: polyamide PA 6.6 + steel + carbon black

Self-extinguishing class: UL 94-V2

Working temperature: -40 °C ÷ +85 °C

Minimum installation temperature: -10 °C

Resistance to chemicals: Good resistance to bases, oils, greases, chloride solvents. Limited resistance to acids. Not resistant to phenols

Reference standards: EN 62275:2015-02

Classification: type 1 (EN)

CE



A	L	Ø MAX	F MAX		
mm	mm	mm	N		
2.5	100	20	180	100	BMNL1025
3.6	140	33	250	100	BMNL1436
2.5	200	52	180	100	BMNL2025
4.8	200	49	360	100	BMNL2048
4.8	300	81	360	100	BMNL3048
4.8	370	103	360	100	BMNL3748
7.6	370	103	780	100	BMNL3776

Please indicate number of cable ties, and not of packages, in your order

1748-BR

reusable nylon cable ties,
natural colour

Material: polyamide PA 6.6

Self-extinguishing class: UL 94-V2

Working temperature: -40 °C ÷ +85 °C

Minimum installation temperature: -10 °C

Resistance to chemicals: Good resistance to bases, oils, greases, chloride solvents. Limited resistance to acids. Not resistant to phenols

Reference standards: EN 62275:2015-02

Classification: type 1 (EN); type 21 (UL)

CE

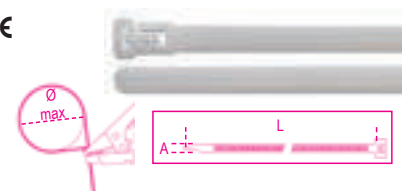

FILE N° E223175

A	L	Ø MAX	F MAX		
mm	mm	mm	N		
7.6	150	40	230	100	BMBR1576
7.6	200	55	230	100	BMBR2076
7.6	300	82	230	100	BMBR3076

Please indicate number of cable ties, and not of packages, in your order

1748-BH

nylon cable ties with eyelets,
natural colour

Material: polyamide PA 6.6

Self-extinguishing class: UL 94-V2

Working temperature: -40 °C ÷ +85 °C

Minimum installation temperature: -10 °C

Resistance to chemicals: Good resistance to bases, oils, greases, chloride solvents. Limited resistance to acids. Not resistant to phenols

Reference standards: EN 62275:2015-02

Classification: type 1 (EN); type 21 (UL)

CE



* FILE N° E223175

A	L	Ø MAX	F MAX		
mm	mm	mm	N		
2.5	110	19	80	100	BMBH1125
* 4.8	200	49	230	100	BMBH2048
* 7.6	305	78	550	100	BMBH3076

Please indicate number of cable ties, and not of packages, in your order

Beta

Beta

1748-BP

insertion nylon cable ties,
natural colour

Material: polyamide PA 6.6
Self-extinguishing class: UL 94-V2
Working temperature: -40 °C + +85 °C
Minimum installation temperature: -10 °C
Resistance to chemicals: Good resistance to bases, oils, greases, chloride solvents. Limited resistance to acids. Not resistant to phenols
Reference standards: EN 62275:2015-02
Classification: type 1 (EN); type 21 (UL)

CE

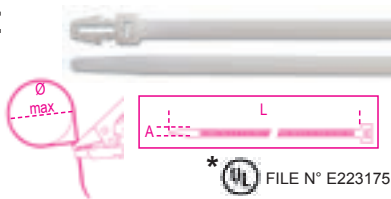

A	L	Ø MAX	F MAX		
mm	mm	mm	N		
3.6	155	37	180	100	BMBP1536
* 4.8	200	50	230	100	BMBP2048

- Please indicate number of cable ties, and not of packages, in your order

1748-BT

nylon cable ties with cross plates, 25x8mm,
natural colour

Material: polyamide PA 6.6
Self-extinguishing class: UL 94-V2
Working temperature: -40 °C + +85 °C
Minimum installation temperature: -10 °C
Resistance to chemicals: Good resistance to bases, oils, greases, chloride solvents. Limited resistance to acids. Not resistant to phenols
Reference standards: EN 62275:2015-02
Classification: type 1 (EN); type 21 (UL)

CE

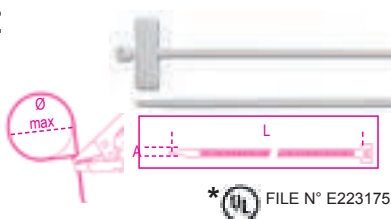

A	L	Ø MAX	F MAX		
mm	mm	mm	N		
* 2.5	100	22	80	100	BMBT21025
2.5	200	53	80	100	BMBT22025

Please indicate number of cable ties, and not of packages, in your order

1748-BT2

nylon cable ties with lengthwise plates,
13x27mm,
natural colour

Material: polyamide PA 6.6
Self-extinguishing class: UL 94-V2
Working temperature: -40 °C + +85 °C
Minimum installation temperature: -10 °C
Resistance to chemicals: Good resistance to bases, oils, greases, chloride solvents. Limited resistance to acids. Not resistant to phenols
Reference standards: EN 62275:2015-02
Classification: type 1 (EN)

CE



A	L	Ø MAX	F MAX		
mm	mm	mm	N		
4.8	190	51	230	100	BMBT12248

Please indicate number of cable ties, and not of packages, in your order

1748-BT3

nylon cable ties with exterior plates, 20x9mm,
natural colour

Material: polyamide PA 6.6
Self-extinguishing class: UL 94-V2
Working temperature: -40 °C + +85 °C
Minimum installation temperature: -10 °C
Resistance to chemicals: good Resistance to bases, oils, greases, chloride solvents. Limited resistance to acids. Not resistant to phenols
Reference standards: EN 62275:2015-02
Classification: type 1 (EN)

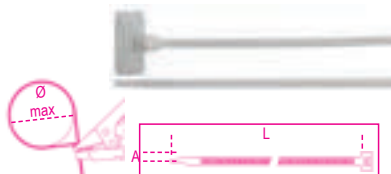

A	L	Ø MAX	F MAX		
mm	mm	mm	N		
2.5	110	22	80	100	BMBT11125

- Please indicate number of cable ties, and not of packages, in your order

1748-BA1

cable tie mounts

Material: polyamide PA 6.6
Self-extinguishing class: UL 94-V2
Working temperature: -40 °C + +85 °C
Minimum installation temperature: -10 °C
Resistance to chemicals: Good resistance to bases, oils, greases, chloride solvents. Limited resistance to acids. Not resistant to phenols

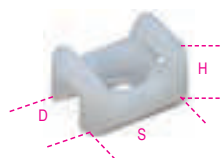

SxDxH	Ø	F		
mm	mm	mm		
15.2x9.4x6.8	3.3	3.6	100	BMB0905
22x16.2x10.8	5.2	9	100	BMB0906

- Please indicate number of cable ties, and not of packages, in your order

1748-NA1

cable tie mounts

Material: polyamide PA 6.6
Self-extinguishing class: UL 94-V2
Working temperature: -40 °C + +85 °C
Minimum installation temperature: -10 °C
Resistance to chemicals: Good resistance to bases, oils, greases, chloride solvents. Limited resistance to acids. Not resistant to phenols



SxDxH	Ø	F		
mm	mm	mm		
15.2x9.4x6.8	3.3	3.6	100	BMN0905
22x16.2x10.8	5.2	9	100	BMN0906

- Please indicate number of cable ties, and not of packages, in your order

1748-BA2

cable tie mounts - two-way

Material: polyamide PA 6.6
Self-extinguishing class: UL 94-V2
Working temperature: -40 °C + +85 °C
Minimum installation temperature: -10 °C
Resistance to chemicals: Good resistance to bases, oils, greases, chloride solvents. Limited resistance to acids. Not resistant to phenols



SxDxH	F		
mm	mm		
19x19x5.4	3.6	100	BMB0901
* 28x28x7	4.8	100	BMB0902
* 28x28x5.8	4.8	100	BMB0903

1748-NA2

cable tie mounts - two-way,
UV resistant

Material: polyamide PA 6.6
Self-extinguishing class: UL 94-V2
Working temperature: -40 °C + +85 °C
Minimum installation temperature: -10 °C
Resistance to chemicals: Good resistance to bases, oils, greases, chloride solvents. Limited resistance to acids. Not resistant to phenols

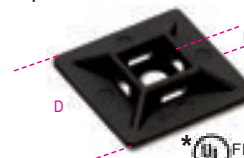

SxDxH	F		
mm	mm		
19x19x5.4	3.6	100	BMN0901
* 28x28x7	4.8	100	BMN0902
* 28x28x5.8	4.8	100	BMN0903

- Please indicate number of cable ties, and not of packages, in your order

 Beta

 Beta

1748-S

self-locking stainless steel cable ties

Material: stainless steel AISI 304
 Locking device: roller ball type
 Self-extinguishing class: non-flammable
 Plenum rating: AH-1
 UV resistance: excellent
 Working temperature: -60 °C ÷ +300 °C
 Minimum installation temperature: -60 °C
 Resistance to chemicals: excellent
 Reference standards: EN 62275:2015-02
 Classification: type 2 (EN); type 2 (UL)

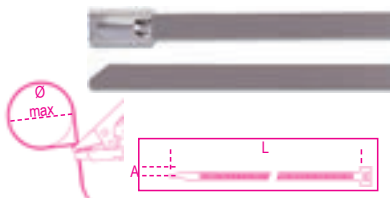

A	L	ØMAX	Trazione		
mm	mm	mm	N		
4.6	125	38	890	100	BMS1345
4.6	200	61	890	100	BMS2045
7.9	200	61	1500	100	BMS2079
4.6	290	90	890	100	BMS3045
7.9	300	90	1500	100	BMS3079
4.6	360	112	890	100	BMS3745
7.9	360	112	1500	100	BMS3779
7.9	520	163	1500	100	BMS5079
4.6	520	163	890	100	BMS5245
4.6	680	214	890	100	BMS6845
7.9	680	214	1500	100	BMS6879
4.6	840	265	890	100	BMS8445
7.9	840	265	1500	100	BMS8479

1748-SC

self-locking stainless steel cable ties,
 black polyester coating

Material: stainless steel AISI 304 + polyester
 Locking device: roller ball type
 Self-extinguishing class: non-flammable
 Plenum rating: AH-1
 UV resistance: excellent
 Working temperature: -60 °C ÷ +300 °C
 Minimum installation temperature: -60 °C
 Resistance to chemicals: excellent
 Reference standards: EN 62275:2015-02
 Classification: type 2 (EN); type 2 (UL)

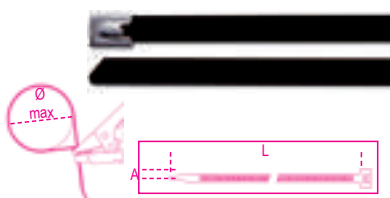

A	L	ØMAX	Trazione		
mm	mm	mm	N		
4.6	125	38	450	100	BMSC1345
4.6	200	61	450	100	BMSC2045
7.9	200	61	800	100	BMSC2079
4.6	290	90	450	100	BMSC3045
7.9	300	90	800	100	BMSC3079
4.6	360	112	450	100	BMSC3745
7.9	360	112	800	100	BMSC3779
7.9	520	163	800	100	BMSC5079
4.6	520	163	450	100	BMSC5245
4.6	680	214	450	100	BMSC6845
7.9	680	214	800	100	BMSC6879
4.6	840	265	450	100	BMSC8445
7.9	840	265	800	100	BMSC8479

1748-ST

automatic clamps for stainless steel cable ties,
 for cable ties with width ranging from 7.6 to 9
 mm,
 automatic tension and cut control



BMS-T 1 BM1105



1639ESB

PVC electrical tape

Working temperature: 0-90°C
 Tensile strength: 28N/cm equivalent to 18.6 N/mm²
 Elongation: 200%
 Adhesion to steel: 2.2N/cm
 Adhesion to backing: 2 N/cm
 Dielectric strength: 45kV/mm
 Flammability: flame retardant
 Reference standards: IEC 60454-2
 Classification: CEI EN 60454-3-1-5/F-PVCP/90



S	A	L		
mm	mm	m		
0.15	15	10	10	BMESB1510BI
0.15	15	10	10	BMESB1510BL
0.15	15	10	10	BMESB1510GI
0.15	15	10	10	BMESB1510GR
0.15	15	10	10	BMESB1510GV
0.15	15	10	10	BMESB1510MA
0.15	15	10	10	BMESB1510NE
0.15	15	10	10	BMESB1510RO
0.15	15	10	10	BMESB1510VE
0.15	15	25	10	BMESB1525BI
0.15	15	25	10	BMESB1525BL
0.15	15	25	10	BMESB1525GI
0.15	15	25	10	BMESB1525GR
0.15	15	25	10	BMESB1525GV
0.15	15	25	10	BMESB1525MA
0.15	15	25	10	BMESB1525NE
0.15	15	25	10	BMESB1525RO
0.15	15	25	10	BMESB1525VE
0.15	19	25	10	BMESB1925BI
0.15	19	25	10	BMESB1925BL
0.15	19	25	10	BMESB1925GI
0.15	19	25	10	BMESB1925GR
0.15	19	25	10	BMESB1925GV
0.15	19	25	10	BMESB1925MA
0.15	19	25	10	BMESB1925NE
0.15	19	25	10	BMESB1925RO
0.15	19	25	10	BMESB1925VE
0.15	25	25	8	BMESB2525BI
0.15	25	25	8	BMESB2525BL
0.15	25	25	8	BMESB2525GI
0.15	25	25	8	BMESB2525GR
0.15	25	25	8	BMESB2525GV
0.15	25	25	8	BMESB2525MA
0.15	25	25	8	BMESB2525NE
0.15	25	25	8	BMESB2525RO
0.15	25	25	8	BMESB2525VE

1639ESC

PVC electrical tape

Working temperature: 0-80°C
 Tensile strength: 28N/cm equivalent to 18.6 N/mm²
 Elongation: 200%
 Adhesion to steel: 2.2N/cm
 Adhesion to backing: 2.2 N/cm
 Dielectric strength: 38kV/mm
 Flammability: flame retardant
 Reference standards: ASTM-D-1000 ; UL510
 Classification: CEI EN 60454-3-1-5/F-PVCP/90



S	A	L		
mm	mm	m		
0.18	19	20	10	BMESC1920NE

1639ETA

PVC electrical tape for extreme temperatures

Working temperature: -18 ÷ +105 °C
 Tensile strength: 35N/cm equivalent to 19.4 N/mm²
 Elongation: 300%
 Adhesion to steel: 3.1N/cm
 Adhesion to backing: 2.7 N/cm
 Dielectric strength: 55.5kV/mm
 Flammability: flame retardant
 Reference standards: ASTM-D-1000 ; UL510
 Classification: CEI EN 60454-3-1-5/F-PVCP/90



S	A	L		
mm	mm	m		
0.18	19	20	10	BMETA1920NE

1639EAB

EPR self-amalgamating electrical tape

Working temperature: -40 ÷ +90 °C
 Tensile strength: 2.4 N/mm²
 Elongation: 750%
 Dielectric strength: 29.5kV/mm
 Flammability: flame retardant
 Reference standards: ASTM-D-4388; ASTM-D-4325
 Excellent resistance to: moisture, corrosion, chemicals



S	A	L		
mm	mm	m		
0.76	19	9	1	BMEAB1909NE



BLISTER PACK RANGE

free-service sales!

- **Increased visibility**
- **Display efficiency**
- **Bar code**



Blister pack support:

- *tearproof PVC*
- *4 formats for optimized display space*
- *New-generation fixing system with elastic band*

42K



mm		
5,5x5,5	5	000429005
6x6	5	000429006
7x7	5	000429007
8x8	5	000429008
9x9	5	000429009
10x10	5	000429010
11x11	5	000429011
12x12	5	000429012
13x13	5	000429013
14x14	5	000429014
15x15	5	000429015
16x16	5	000429016
17x17	5	000429017
18x18	5	000429018
19x19	5	000429019
20x20	3	000429020
21x21	3	000429021
22x22	3	000429022
23x23	3	000429023
24x24	3	000429024
25x25	2	000429025
26x26	2	000429026
27x27	2	000429027
28x28	2	000429028
29x29	2	000429029
30x30	2	000429030
32x32	2	000429032

55K



mm		
6x7	5	000559012
8x9	5	000559021
10x11	5	000559030
10x12	5	000559033
10x13	5	000559035
12x13	5	000559042
12x14	5	000559045
13x17	5	000559051
14x15	5	000559054
14x17	5	000559057
16x17	5	000559060
17x19	2	000559063
18x19	2	000559066
19x22	2	000559069
20x22	2	000559075
21x23	2	000559078
22x24	2	000559081
24x26	2	000559087
24x27	2	000559090
25x28	2	000559096
27x29	2	000559099
27x30	2	000559102
30x32	2	000559108

90K



mm		
6x7	5	000909006
8x9	5	000909012
10x11	5	000909018
12x13	5	000909027
14x15	5	000909033
16x17	5	000909039
18x19	5	000909045
20x22	3	000909051
21x23	2	000909057
24x26	2	000909063

mm		
24x27	2	000909067
25x28	2	000909070
27x29	2	000909073
30x32	2	000909080

93K



mm		
21x22	3	000939021

94K



mm		
8x10	2	000949008
9x11	2	000949009
10x11	2	000949010
11x13	2	000949011
12x14	2	000949012
13x15	2	000949013
14x15	2	000949014
14x17	2	000949015
17x19	2	000949017
19x22	2	000949019
22x24	2	000949022
24x27	2	000949024
30x32	2	000949030

96/SC9



96/SC9	1	000960374

96/ST6K



96/ST6K	3	000969370

96N/ST6K



96N/ST6K	3	000969640

96BPA/SC9



96BPA/SC9	1	000961974

96BPC/SC9



96BPC/SC9	1	000960354

96C/AS



"		
1/16	20	000961702
3/32	20	000961706
1/8	20	000961710
5/32	20	000961714
3/16	20	000961716
7/32	20	000961718
1/4	20	000961720
5/16	10	000961724
3/8	10	000961728

96LBP/SC9



96LBP/SC9	1	000961354

96/BGS7



96/BGS7	1	000960367

96/BG7



96/BG7
2,5-3-4-5-6-8-10 mm

1 000960368

96TK



mm		
2	5	000969934
2,5	5	000969935
3	5	000969936
4	5	000969938
5	5	000969940
6	5	000969941
8	3	000969943
10	3	000969945

97BTX/SC8



97BTX/SC8
T9-T10-T15-T20-T25-T27-T30-T40

1 000970164

97BTXL/SC8



97BTXL/SC8
T9-T10-T15-T20-T25-T27-T30-T40

1 000970364

111K



L mm		
100	3	001119010
150	3	001119015
200	3	001119020
250	3	001119025
300	3	001119030

123/K4



123/K4

1 001230504

142K



mm		
6	3	001429006
7	3	001429007
8	3	001429008
9	3	001429009
10	3	001429010
11	3	001429011
12	3	001429012
13	3	001429013
14	2	001429014
15	2	001429015
16	2	001429016
17	2	001429017
18	2	001429018
19	2	001429019
21	1	001429021
22	1	001429022
24	1	001429024

192/S2



192/S2
8x10/12x13 mm
16x17/18x19 mm

1 001920070

195K



mm		
8x10	2	001959010
12x13	2	001959013
14x15	2	001959015
16x18	2	001959018
17x19	2	001959019

374K



L mm		
240	1	003749024

850MQ



1000 V



L mm		
233	1	008500910

855P



L1 mm		
240	1	008550010

860/58K



L mm		
126	1	008609884

860LP



SxA mm		
0,5x3	5	008600005
0,6x4,5	5	008600010
0,8x5,5	5	008600015
1x5,5	5	008600020
1,2x6,5	5	008600025

860PH



PH		
0	5	008600220
1	5	008600225
2	5	008600230
3	5	008600245
4	5	008600250

860PZ



PZ		
1	5	008600320
2	5	008600325
3	5	008600330
4	5	008600335

860PE



mm	5	008600101
2	5	008600102
2,5	5	008600103
3	5	008600104
4	5	008600105
5	5	008600106
6	5	008600108
8	5	008600110
10	5	008600110

860TX



mm	5	008600704
T6	5	008600705
T7	5	008600710
T8	5	008600715
T9	5	008600720
T10	5	008600725
T15	5	008600730
T20	5	008600735
T25	5	008600740
T27	5	008600745
T30	5	008600750
T40	5	008600750

860RTX



mm	5	008600550
T9	5	008600555
T10	5	008600560
T15	5	008600565
T20	5	008600570
T25	5	008600575
T27	5	008600580
T30	5	008600585
T40	5	008600585

860/C27



860/C27 1 008600880

860MIX/A10



860MIX/A10 1 008600900

860TX/A10



860TX/A10 1 008600970

860MIX/A31



860MIX/A31 1 008600902

862F/A7



862F/A7 1 008620950

900K



mm	10	009009040
4	10	009009045
4,5	10	009009050
5	10	009009055
5,5	10	009009060
6	10	009009070
7	10	009009080
8	10	009009090
9	10	009009100
10	10	009009110
11	10	009009120
12	10	009009130
13	10	009009140

900/20LK



900/20LK 1 009009819

900/25K



900/25K 1 009009830

900BG/30K



900BG/30K 1 009009834

900/55K



900/55K 1 009009870

900/58K



900/58K 2 009009884

910AK



mm	5	009109006
6	5	009109007
7	5	009109008
8	5	009109009
9	5	009109010
10	5	009109011
11	5	009109012
12	5	009109013
13	5	009109014
14	5	009109015
15	5	009109016
16	5	009109017
17	5	009109018
18	5	009109019
19	5	009109020
20	5	009109021
21	5	009109022
22	5	009109022

910/21K



910/21K 1 009109822

910/25K

3/8"



L mm	5	009109830
54,6		

910/55K

7/2"
3/8"



L mm	3	009109882
200		

910/58K

3/8"



L mm	1	009109884
222		

920AK

1/2"



mm		
10	10	009209010
11	10	009209011
12	10	009209012
13	10	009209013
14	10	009209014
15	10	009209015
16	10	009209016
17	10	009209017
18	10	009209018
19	10	009209019
20	5	009209020
21	5	009209021
22	5	009209022
23	5	009209023
24	5	009209024
25	5	009209025
26	5	009209026
27	5	009209027
28	5	009209028
29	5	009209029
30	5	009209030
32	5	009209032

920/21K

1/2"



L mm	5	009209822
125		

920/25K

1/2"



L mm	5	009209830
75		

920/55K

7/2"
1/2"



L mm	3	009209882
275		

920/58K

1/2"



L mm	1	009209926
281		

935K



mm		
6x7	5	009359105
8x9	5	009359111
10x11	5	009359115
12x13	5	009359117
14x15	5	009359126
16x17	5	009359128
18x19	5	009359131
20x22	3	009359138

937K



mm		
6x6	5	009379006
7x7	5	009379007
8x8	5	009379008
9x9	5	009379009
10x10	5	009379010
11x11	5	009379011
12x12	5	009379012
13x13	5	009379013
14x14	5	009379014
15x15	5	009379015
16x16	5	009379016
17x17	5	009379017
18x18	5	009379018
19x19	5	009379019
20x20	5	009379020
21x21	3	009379021
22x22	3	009379022

943BXX



mm	5	009439005
5,5		
6	5	009439006
7	5	009439007
8	5	009439008
10	3	009439010
13	3	009439013

951K



mm	5	009519521
2		
2,5	5	009519525
3	5	009519530
3,5	5	009519535
4	5	009519540
4,5	5	009519545
5	5	009519550
6	5	009519560
8	5	009519580
10	5	009519610

1032K



L mm	5	010329013
140x0,9		
140x1,3	5	010329014
180	5	010329017

1033K



L mm	5	010339013
140x0,9		
140x1,3	5	010339014
180	5	010339017

1034K



L mm	5	010349013
130x0,9		
130x1,3	5	010349014
170	5	010349017

1036K



L mm		
140x0,9	5	010369013
140x1,3	5	010369014
175	5	010369017

1037K



L mm		
140x0,9	5	010379013
140x1,3	5	010379014
175	5	010379017

1038K



L mm		
135x0,9	5	010389013
135x1,3	5	010389014
175	5	010389017

1044K



L mm		
250	5	010449250

1044FK



L mm		
250	5	010449015

1046K



L mm		
240	5	010469240

1048K



L mm		
175	3	010489010
250	5	010489250

1048VK



L mm		
175	3	010489110
250	5	010489025

1052K



L mm		
140	3	010529014
190	3	010529019
240	3	010529024

1082K



L mm		
140	5	010829004
160	5	010829006

1082BMK



L mm		
140	3	010829034
160	3	010829036

1084K



L mm		
160	3	010849006

1084BMK



L mm		
160	3	010849036

1088K



L mm		
160	2	010889006

1088BMK



L mm		
160	2	010889036

1096K



L mm		
200	5	010969020

1098K



L mm		
190	5	010989190
220	5	010989220

1098PLK



L mm		
220	5	010989320

1112K



L mm 200 2 011129020

1122K



L mm 250 2 011229020

1123K



L mm 250 2 011239020

1124K



L mm 250 2 011249020

1128BAX



L mm 150 5 011280088

1128BCX



L mm 155 5 011280080

1128BMX



L mm 147 5 011280051

1128BSX



L mm 148 5 011280061

1128FX



L mm 145 5 011280090

1128FXS



L mm 145 5 011280095

1129BMK



L mm 145 5 011299000

1130BMX



L mm 185 1 011300002

1132K



L mm 170 2 011329107

1132BMK



L mm 170 2 011329137

1142BMK



L mm 160 3 011429036

1149F



L mm 175 1 011490010

1150K



L mm 160 5 011509006
180 5 011509008
200 5 011509010
220 2 011509012

1150BMK



L mm		
160	3	011509036
180	3	011509038
200	3	011509040
220	2	011509042

1162K



L mm		
160	5	011629006
200	5	011629010

1162BMK



L mm		
160	3	011629036
200	3	011629040

1164K



L mm		
160	5	011649006
200	5	011649010

1164BMK



L mm		
160	3	011649036
200	3	011649040

1166K



L mm		
160	5	011669006
200	5	011669010

1166BMK



L mm		
160	3	011669036
200	3	011669040

1168K



L mm		
160	5	011689006
200	5	011689010

1168BMK



L mm		
160	3	011689036
200	3	011689040

1201K



SxAxL mm		
0,4x2,5x50	5	012019003
0,4x2,5x75	5	012019006
0,5x3x75	5	012019009
0,5x3x100	5	012019012
0,6x3,5x75	5	012019018
0,6x3,5x100	5	012019021
0,8x4x100	5	012019030
0,8x4x125	5	012019033
0,8x4x150	5	012019036
1,0x5,5x100	5	012019039
1,0x5,5x125	5	012019040
1,0x5,5x150	5	012019042
1,2x6,5x100	5	012019048
1,2x6,5x125	5	012019050
1,2x6,5x150	5	012019051
1,2x8x150	3	012019057
1,2x8x200	3	012019060
1,6x10x200	3	012019066

1201NK



SxAxL mm		
0,8x4x30	3	012019103
1,2x6,5x30	3	012019106

1202K



PHxDxL mm		
0x3x60	5	012029003
0x3x100	5	012029006
1x4,5x80	5	012029009
2x6x100	5	012029018
3x8x150	3	012029024
1x4,5x120	5	012029012
2x6x150	5	012029021
4x9,5x200	3	012029027

1202NK



PHxDxL mm		
1x4,5x30	3	012029103
2x6x30	3	012029106

1204K



SxDxL mm		
0,4x2,5x60	5	012049003
0,6x3x75	5	012049006
0,5x3x100	5	012049009
0,8x4x100	5	012049012
0,8x4x125	5	012049015
1,0x5x125	5	012049018
1,0x5x150	5	012049021
1,2x6,5x150	5	012049024

1207TXK



Type		
T5	5	012079005
T6	5	012079006
T7	5	012079007
T8	5	012079008
T9	5	012079009
T10	5	012079010
T15	5	012079015
T20	5	012079020
T25	5	012079025
T27	5	012079027
T30	5	012079030
T40	2	012079040
T45	2	012079045

1208RTXK



Type		
T9	5	012089009
T10	5	012089010
T15	5	012089015
T20	5	012089020
T25	5	012089025
T27	5	012089027
T30	5	012089030
T40	2	012089040

1209PZK



PZ		
0	5	012099000
1	5	012099003
2	5	012099006
3	3	012099009
4	3	012099012

1209N/PZK



1	3	012099103
2	3	012099106

1253



SxAxL mm		
0,5x3,5x100	5	012530001

1254



SxAxL mm		
0,5x3x44	5	012540001

1260K



SxAxL		
0,4x2,5x50	5	012609003
0,4x2,5x75	5	012609006
0,5x3x75	5	012609009
0,5x3x100	5	012609012
0,6x3,5x75	5	012609018
0,6x3,5x100	5	012609021
0,8x4x100	5	012609030
0,8x4x125	5	012609033
0,8x4x150	5	012609036
1x5,5x100	5	012609039
1x5,5x150	5	012609042
1,5x6,5x100	5	012609048
1,2x6,5x150	5	012609051
1,2x8x150	3	012609057
1,2x8x200	3	012609060
1,6x10x200	3	012609066

1260NK



SxAxL mm		
0,8x4x30	5	012609103
1,2x6,5x30	5	012609106

1260EK



SxAxL mm		
1,2x6,5x150	3	012609156
1,2x8x175	3	012609157
1,6x10x200	2	012609159
2x12x250	2	012609162

1262K



PHxDxL mm		
0x3x60	5	012629003
0x3x100	5	012629006
1x4,5x80	5	012629009
1x4,5x120	5	012629012
2x6x100	5	012629018
2x6x150	5	012629021
3x8x150	3	012629024
4x10x200	3	012629027

1262NK



PHxDxL		
1x4,5x30	5	012629103
2x6x30	5	012629106

1262EK



PHxDxL mm		
2x6x150	3	012629153
3x8x175	3	012629156
4x10x200	3	012629159

1264K



SxDxL mm		
0,5x2,5x60	5	012649003
0,6x3x75	5	012649006
0,6x3x100	5	012649009
0,8x4x100	5	012649012
0,8x4x125	5	012649015
1x5x125	5	012649018
1x5x150	5	012649021
1,2x6,5x150	5	012649024

1267TXK



T5	5	012679005
T6	5	012679006
T7	5	012679007
T8	5	012679008
T9	5	012679009
T10	5	012679010
T15	5	012679015
T20	5	012679020
T25	5	012679025
T27	5	012679027
T30	5	012679030
T40	2	012679040
T45	2	012679045

1268RTXK



T9	3	012689009
T10	3	012689010
T15	3	012689015
T20	3	012689020
T25	3	012689025
T27	3	012689027
T30	3	012689030
T40	2	012689040

1269PZK



PZ		
0	5	012699000
1	5	012699001
2	5	012699002
3	3	012699003
4	3	012699004

1269N/PZK



PZ	mm	mm	mm
1	5	012699011	
2	5	012699012	

1290K



SxAxL mm	mm	mm	mm
0,4x2,5x50	5	012909003	
0,4x2,5x75	5	012909006	
0,5x3x75	10	012909009	
0,5x3x100	10	012909012	
0,6x3,5x75	10	012909018	
0,6x3,5x100	10	012909021	
0,8x4x100	10	012909030	
0,8x4x125	10	012909033	
0,8x4x150	10	012909036	
1x5,5x100	10	012909039	
1x5,5x150	10	012909042	
1,2x6,5x100	10	012909048	
1,2x6,5x150	10	012909051	
1,2x8x150	3	012909057	
1,2x8x200	3	012909060	
1,6x10x200	3	012909066	

1290NK



SxAxL mm	mm	mm	mm
0,8x4x30	5	012909103	
1,2x6,5x30	5	012909106	

1290K/INOX



SxAxL mm	mm	mm	mm
0,4x2,5x50	4	012909403	
0,5x3x75	4	012909409	
0,8x4x100	4	012909430	
1,0x5,5x150	4	012909442	
1,2x6,5x150	4	012909451	

1292K



PHxDxL mm	mm	mm	mm
0x3x60	10	012929003	
0x3x100	5	012929006	
1x4,5x80	10	012929009	
1x4,5x120	10	012929012	
2x6x100	10	012929018	
2x6x150	10	012929021	
3x8x150	3	012929024	
4x10x200	3	012929027	

1292NK



PHxDxL mm	mm	mm	mm
1x4,5x30	5	012929103	
2x6x30	5	012929106	

1292K/INOX



PHxDxL mm	mm	mm	mm
0x3x60	4	012929403	
1x4,5x80	4	012929409	
2x6x100	4	012929418	

1294K



SxDxL mm	mm	mm	mm
0,5x2,5x60	5	012949003	
0,6x3x75	5	012949006	
0,8x4x100	5	012949012	
1x5x125	5	012949018	

1298RTXK



T	mm	mm	mm
T9	5	012989009	
T10	5	012989010	
T15	5	012989015	
T20	5	012989020	
T25	5	012989025	
T27	5	012989027	
T30	5	012989030	
T40	2	012989040	

1299PZK



PZ	mm	mm	mm
0	5	012999000	
1	5	012999003	
2	5	012999006	

1299N/PZK



PZ	mm	mm	mm
1	5	012999021	
2	5	012999024	

1472VW



L mm	mm	mm	mm
200	1	014720051	

1473P



A Max mm	mm	mm	mm
53	1	014730020	

1497RC



1497RC	mm	mm	mm
	1	014970351	

1603K



mm ²	mm	mm	mm
0÷8	5	016039001	

1603BK



mm ²	mm	mm	mm
0÷8	2	016039010	

1691BM

CE



L m	Q	Code
5	1	016910205
8	1	016910208
10	1	016910210

1692

CE



L m	Q	Code
2	5	016920052
3	5	016920053
5	5	016920055
8	5	016920058

1729CG



L mm	Q	Code
310	2	017290200

1729DM 450



L mm	Q	Code
450	4	017290450

1741U



Ø mm	2,4	3	3,2	4	4,8
Aluminium	•	•	•	•	•
Steel	•	•	•	•	•
Stainless steel	•	•	•	•	•

L mm	Q	Code
1741U	1	017410450

1741B



Ø mm	2,4	3,2	4	4,8	5
Aluminium	•	•	•	•	•
Steel	•	•	•	•	•
Stainless steel	•	•	•	•	•

L mm	Q	Code
1741B	1	017410000

1760K

CE



CAT III-1000V



L mm	Q	Code
1760K	1	017600140

1762K



Ø mm	Q	Code
2-2,5-3 3,5-4-4,5	2	017629001

1771



L mm	Q	Code
1771	10	017710000

1770BM



L mm	Q	Code
1770BM	10	017700050

1771BM



L mm	Q	Code
1771BM	10	017710050

1771HD



L mm	Q	Code
1771HD	5	017710100

1772R



L mm	Q	Code
1772R	5	017720006

1773A



L mm	Q	Code
1773A	10	017730000

1777BMT



L mm	Q	Code
1777BMT	5	017770050

1777T



L mm	Q	Code
1777T	5	017770030

1783



L mm	Q	Code
1783	5	017830021
240	5	017830024

1820



1820 30 30W L = 210mm	1	018200003
1820 60 60W L = 220mm	1	018200006
1820 80 80W L = 260mm	1	018200008

1822



1822 120 120W LxA = 250x125 mm	1	018220012
1822 180 180W LxA = 250x125mm	1	018220018
1822 320 320W LxA = 250x140mm	1	018220032

1834PS



L mm 150	1	018340310
----------------	---	-----------

1834PM



L mm 140	1	018340320
----------------	---	-----------

1834PL



L mm 210	1	018340325
----------------	---	-----------

1834PXL



1834PXL	1	018340330
---------	---	-----------

1834RR



1834RR	1	018340520
--------	---	-----------

1836A



1836A	1	018360050
-------	---	-----------

1836B



1836B	1	018360200
-------	---	-----------

1837N



L mm 450	1	018370002
----------------	---	-----------

1838COB



1838COB	1	018380010
---------	---	-----------

1838P



1838P	1	018380005
-------	---	-----------

1838SLR



1838SLR	1	018380201
---------	---	-----------

1838SN



1838SN	1	018380132
--------	---	-----------

6888B1/4

blister support for 1/4" sockets



6888B1/4	50	068880900
----------	----	-----------

6888B3/8

blister support for 3/8" sockets



6888B3/8	50	068880910
----------	----	-----------

6888B1/2

blister support for 1/2" sockets



6888B1/2	50	068880920
----------	----	-----------



 **Beta**
SHOP
in Shop

DISPLAY UNITS FOR SALES POINTS



BUILD YOUR BETA CORNER
www.beta-tools.com/beta/3d/

38/DS1

wall-mounted display
with 75 punches



495x260x332 mm

display
with assortment

38/DS1 1 000380701

n.

30	Ø 2 - 3 - 4 - 5 - 6 mm	5
31	Ø 2 - 3 - 4 - 5 - 6 - 8 - 10 mm	5
32	Ø 3 - 4 - 5 mm	5

empty
display

38/DVS1 1 000380751

38/DS2

wall-mounted display
with 65 chisels

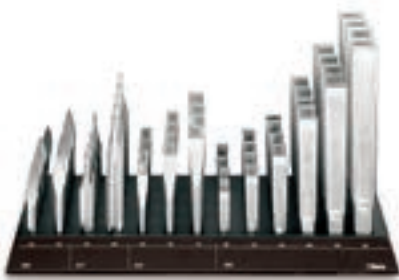

495x260x332 mm

display
with assortment

38/DS2 1 000380702

n.

34	125 - 150 - 175 mm	5
35	100 - 125 - 150 - 200 - 250 - 300 mm	5
36	125 - 150 mm	5
37	150 - 200 mm	5

empty
display

38/DVS2 1 000380752

942BX/DG

wall-mounted display
with 43 hi-torque hexagon nut spinners,
short series



330x260x332 mm

display
with assortment

942BX/DG 1 009420701

n.

942BX	5 - 5,5 mm	3
	6 - 7 mm	6
	8 - 9 - 10 mm	5
	11 mm	2
	12 mm	3
	13 mm	5

empty
display

942BX/DVG 1 009420751

943BX/DG

wall-mounted display
with 43 hi-torque hexagon nut spinners,
long series



330x260x332 mm

display
with assortment

943BX/DG 1 009430701

n.

943BX	5 - 5,5 mm	3
	6 - 7 mm	6
	8 - 9 - 10 mm	5
	11 mm	2
	12 mm	3
	13 mm	5

empty
display

943BX/DVG 1 009430751

944BX/DG

wall-mounted display with 43 deep hi-torque
hexagon nut spinners with handles, long
series



330x260x332 mm

display
with assortment

944BX/DG 1 009440701

n.

944BX	5 - 5,5 mm	3
	6 - 7 mm	6
	8 - 9 - 10 mm	5
	11 mm	2
	12 mm	3
	13 mm	5

empty
display

944BX/DVG 1 009440751

943MQ/BG

wall-mounted display
with 30 hexagon nut spinners



⚠ 1000 V ⚡

330x260x332 mm

display
with assortment

943MQ/BG 1 009430281

n.

943MQ	5,5 - 6 - 7 - 8 - 10 - 13 mm	5
-------	------------------------------	---

empty
display

943BG-MQ/DV 1 009430285

1203/E1P

wall-mounted display with 82 screwdrivers



495x260x310 mm

display with assortment
1203/E1P 1 012030301

		n.
● 1201	0,4x2,5x50 - 0,5x3x75 - 0,6x3,5x100	7
	0,8x4x100 - 0,8x4x125 mm	
	1,0x5,5x100 - 1,0x5,5x150 - 1,2x6,5x150 mm	6
	1,2x8x150 mm	5
⊕ 1202	PH0x3x60 mm	7
	PH1x4,5x80 - PH2x6x100 mm	6
	PH3x8x150 mm	5

empty display
1203/EV1P 1 012030351

1203/E4P

wall-mounted display with 85 screwdrivers



495x260x310 mm

display with assortment
1203/E4P 1 012030304

		n.
● 1201	0,4x2,5x50 - 0,5x3x75 - 0,8x4x125 mm	7
	1,0x5,5x100 - 1,0x5,5x150 - 1,2x6,5x150 mm	6
	● 1204	0,4x2,5x60 - 0,5x3x100 - 0,8x4x100 mm
	1,0x5x125 mm	6
⊕ 1209PZ	PZ0x3x60 mm	7
	PZ1x4,5x80 - PZ2x6x100 mm	6

empty display
1203/EV4P 1 012030354

1203/E5P

wall-mounted display with 82 screwdrivers



495x260x310 mm

display with assortment
1203/E5P 1 012030305

		n.
⊕ 1202	PH0x3x60 mm	7
	PH1x4,5x80 - PH1x4,5x120	6
	PH2x6x100 - PH2x6x150 mm	
	PH3x8x150 mm	5
● 1204	0,4x2,5x60 - 0,5x3x100 - 0,8x4x100 mm	7
	1,0x5x125 mm	6
	⊕ 1209PZ	PZ0x3x60 mm
	PZ1x4,5x80 - PZ2x6x100 mm	6

empty display
1203/EV5P 1 012030355

1203/E10P

wall-mounted display with 80 screwdrivers



495x260x310 mm

display with assortment
1203/E10P 1 012030310

		n.
⊕ 1207TX	T6	4
	T7	3
	T8	7
	T9 - T10 - T15 - T20 - T25	6
	T27 - T30	3
⊕ 1208TX	T9 - T10	3
	T15 - T20 - T25	6
	T27 - T30	3

empty display
1203/EV10P 1 012030360

1263/E78

wall-mounted display with 78 screwdrivers



495x260x310 mm

display with assortment
1263/E78 1 012630510

		n.
● 1260	2,5x75-3x75-3,5x100 mm	7
	4x100-4x125-5,5x100-5,5x150-6,5x150 mm	6
	8x150 mm	4
	⊕ 1262	PH0x60 mm
	PH1x80-PH2x100 mm	6
	PH3x150	4

empty display
1263/EV78 1 012630511

1263/E74

wall-mounted display with 74 screwdrivers



495x260x310 mm

display with assortment
1263/E74 1 012630540

		n.
● 1264	2,5x60 mm	7
	3x75 mm	3
	3x100 - 4x100 mm	4
	4x125 - 5x150 mm	2
	5x125 - 6,5x150 mm	4
⊕ 1262	PH 8x150	3
	PH 3x60 - 3x100 mm	7
	PH 4,5x80 - 4,5x120 mm	6
	PH 6x100 mm	10
	PH 6x150 mm	5

empty display
1263/EV74 1 012630541

1263/E85

wall-mounted display
with 85 screwdrivers



495x260x377 mm

display
with assortment
1263/E85

1 012630550

	n.
● 1260 2,5x50 mm	7
2,5x75 mm	6
3x75 - 3x100 - 3,5x100 mm	7
4x100 - 4x125 - 5,5x125	6
5,5x150 - 6,5x150 mm	4
8x150 mm	4
● 1260E 10x200 mm	3
12x250 mm	2
4x30 - 6,5x30 mm	6

empty
display
1263/EV85

1 012630551

1263/E70

wall-mounted display
with 70 screwdrivers



495x260x327 mm

display
with assortment
1263/E70

1 012630560

	n.
⊕ 1262 PH0x60 - PH0x100 mm	7
PH1x80 - PH1x120 mm	6
PH2x100 mm	9
PH2x150 - PH3x150 mm	5
PH4x200 mm	4
⊕ 1262E PH2x150 mm	5
PH3x175 mm	4
⊕ 1262N PH1x30 - PH2x30 mm	6

empty
display
1263/EV70

1 012630561

1263/E50

wall-mounted display
with 50 screwdrivers



330x260x269 mm

display
with assortment
1263/E50

1 012630570

	n.
● 1264 2,5x60 - 3x75 - 3x100 mm	7
4x100 - 4x125 - 5x125 - 5x150 mm	6
6,5x150 mm	5

empty
display
1263/EV50

1 012630571

1263/E62

wall-mounted display
with 62 screwdrivers



495x260x257 mm

display
with assortment
1263/E62

1 012630590

	n.
⊕ 1267TX T5	5
T6	6
T7	5
T8	6
T9	5
T10 - T15 - T20	6
T25	5
T27 - T30	4
T40 - T45	2

empty
display
1263/EV62

1 012630591

1263/E39

wall-mounted display
with 39 screwdrivers



330x260x257 mm

display
with assortment
1263/E39

1 012630595

	n.
⊕ 1268RTX T9x60 - T10x80 - T15x80	6
T20x100 - T25x100 mm	4
T27x115 mm	3
T30x115 mm	2
T40x130 mm	2

empty
display
1263/EV39

1 012630596

1263/E40

wall-mounted display
with 40 screwdrivers



330x260x327 mm

display
with assortment
1263/E40

1 012630580

	n.
⊕ 1269 PZ0x60 mm	7
PZ1x80 mm	6
PZ2x100 - PZ3x150 - PZ4x200 mm	5
⊕ 1269N PZ1x30 - PZ2x30 mm	6

empty
display
1263/EV40

1 012630581

1273MQ/E1

wall-mounted display with 40 screwdrivers



△ 1000 V ⚡

330x260x332 mm

display with assortment
1273MQ/E1 1 012730312

		n.
➕ 1272MQ	PH0x60 - PH1x80 mm	5
	PH2x100 mm	3
	PH3x150 mm	2
● 1274MQ	3x100 - 4x100 - 5,5x125 - 6,5x150 mm	5
	8x175 mm	3
	10x200 mm	2

empty display
1273BG-MQ/DV 1 012730651

1273MQ/E2

wall-mounted display with 43 screwdrivers



△ 1000 V ⚡

330x260x332 mm

display with assortment
1273MQ/E2 1 012730313

		n.
➕ 1272MQ/F	4,5x80 - 6x100 mm	3
● 1274MQ/F	3,5x100 - 4,5x100 - 5,5x125 - 6,5x150 mm	3
➕ 1275MQ/C	4,5x80 - 6x100 mm	5
● 1276MQ/C	4,5x80 - 6x100 mm	5
● 1279MQ/F	4,5x80	3
	6x100	2

empty display
1273BG-MQ/DV-2 1 012730653

1293BX/DA

wall-mounted display with 90 screwdrivers



495x260x332 mm

display with assortment
1293BX/DA 1 012930701

		n.
● 1290	3x75 - 3,5x100 - 4x100 - 4x125 5,5x100 - 5,5x150 mm	7
	6,5x150 mm	6
	8x150 mm	3
	10x200 mm	2
● 1290N	4x30 - 6,5x30 mm	3
➕ 1292	PH0x60 - PH1x80 mm	7
	PH2x100 mm	6
	PH3x150 mm	5
➕ 1292N	PH1x30 - PH2x30 mm	3

empty display
1293BX/DVA 1 012930751

1293BX/DD

wall-mounted display with 48 screwdrivers



330x260x332 mm

display with assortment
1293BX/DD 1 012930704

		n.
● 1294	2,5x60 - 3x75 - 3x100 - 4x100 4x150 - 5x125 mm	7
	6,5x150 mm	6

empty display
1293BX/DVD 1 012930754

1293BX/DE

wall-mounted display with 42 screwdrivers



330x260x332 mm

display with assortment
1293BX/DE 1 012930705

		n.
➕ 1299PZ	PZ0x60 - PZ1x80 mm	7
	PZ2x100 mm	6
	PZ3x150 - PZ4x200 mm	5
➕ 1299N/PZ	PZ1x30 - PZ2x30 mm	6

empty display
1293BX/DVE 1 012930755

1293BX/DF

wall-mounted display with 59 screwdrivers



330x260x332 mm

display with assortment
1293BX/DF 1 012930706

		n.
● 1297TX	T6 - T8 - T10 - T15 - T20 - T25 T27 - T30	7
	T40	6
		5

empty display
1293BX/DVF 1 012930756

C68

Beta wall display, empty



1000x560x2200 mm

C68/1	1 m	1	068000001
C68/2	2 m	1	068000002
C68/3	3 m	1	068000003
C68/4	4 m	1	068000004
C68/5	5 m	1	068000005
C68/6	6 m	1	068000006
C68/7	7 m	1	068000007
C68/8	8 m	1	068000008
C68/9	9 m	1	068000009
C68/10	10 m	1	068000010

C68 G

"gondola" display



1000x1120x1600 mm

C68G/1	1 m	1	068000051
C68G/2	2 m	1	068000052
C68G/3	3 m	1	068000053
C68G/4	4 m	1	068000054

C88 R/1

Robur wall display, empty



1000x560x2200 mm

C88R/1	1 m	1	088000001
--------	-----	---	-----------

C88VE

display tray for display walls C88

suitable for housing coils of chains item 8120



C88VE	1	088000120
-------	---	-----------

C88SE

display tray for Genovese chain reels



C88SE	1	088000130
-------	---	-----------

1700x600x600 mm

6888

hooks for displays C60 - C61 - C68 - C88



6888S1	10	068880011
6888S2	10	068880012
6888D1	5	068880021
6888D2	5	068880022
6888D4	5	068880024
6888D5	5	068880025
6888T1	5	068880031
6888T2	5	068880032
6888CT	1	068880044
6888B	1	068880100
6888GA	3	068880120
6888S-1/4	1	068880605
6888S-3/8	1	068880610

6800 VE

showcase for wall displays C68 and C68 R/1



6800VE/1	1 m	1	068000401
6800VE/2	2 m	1	068000402
6800VE/3	3 m	1	068000403
6800VE/4	4 m	1	068000404
6800VE/5	5 m	1	068000405

Beta

ACCESSORIES



6800AE	1	068000145
6800AI	1	068000140
6800AD/P	1	068000143



6800CB/100	1	068000104
6800FB/100	1	068000109
6800FO/100	1	068000108
6800PL	1	068000137
6800RP/100	1	068000150
6800GR/37	1	068000159

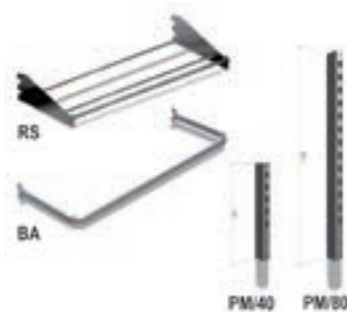

6800BA	1	068000130
6800RS	1	068000135
6800PM/40	1	068000171
6800PM/80	1	068000172

6600 M/11

assortment of 154 tools,
with hooks without panel



6600 M/11	1	066000011
-----------	---	-----------

6600 M/22

assortment of 108 tools,
with hooks without panel



6600 M/22	1	066000022
-----------	---	-----------

6600 M/27

assortment of 25 tools,
with hooks without panel



6600 M/27	1	066000027
-----------	---	-----------

6600 M/33

assortment of 37 tools, with hooks without
panel



6600 M/33	1	066000033
-----------	---	-----------

6600 M/40

assortment of 100 tools,
with hooks without panel

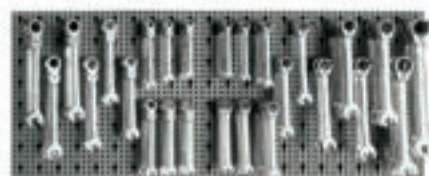

6600 M/40	1	066000040
-----------	---	-----------

6600 M/42

assortment of 65 tools,
with hooks without panel



6600 M/42	1	066000042
-----------	---	-----------

6600 M/47

assortment of 65 tools,
with hooks without panel



6600 M/47	1	066000047
-----------	---	-----------

6600 M/51

assortment of 257 tools
with hooks without panel



6600 M/51	1	066000051
-----------	---	-----------

6600 M/52

assortment of 176 tools
with hooks without panel





6600 M/52	1	066000052
-----------	---	-----------

6600 M/58

assortment of 150 tools
with hooks without panel





6600 M/58   1 066000058

6600 M/61

assortment of 71 tools,
with hooks without panel





6600 M/61   1 066000061

6600 M/63

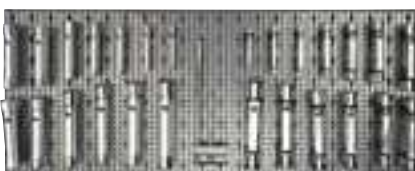
assortment of 110 tools
with hooks without panel





6600 M/63   1 066000063

6600 M/73

assortment of 68 tools
with hooks without panel





6600 M/73   1 066000073

6600 M/112

assortment of 329 tools,
with hooks without panel





6600 M/112   1 066000112

6600 M/116

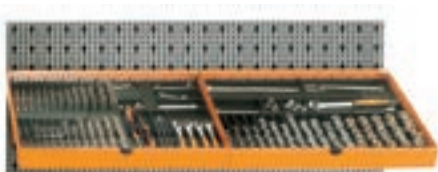
assortment of 306 tools,
with hooks without panel





6600 M/116   1 066000116

6600 M/120

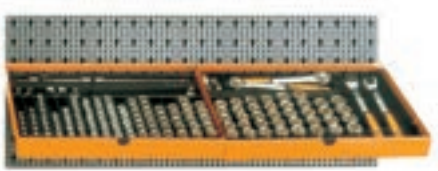
assortment of 163 tools,
with hooks without panel





6600 M/120   1 066000120

6600 M/125

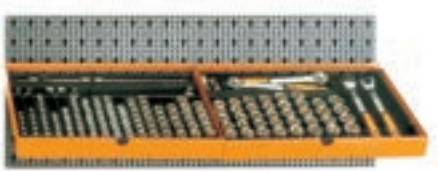
assortment of 133 tools,
with hooks without panel





6600 M/125   1 066000125

6600 M/126

assortment of 58 tools,
with hooks without panel





6600 M/126   1 066000126

6600 M/131

assortment of 92 tools,
with hooks without panel





6600 M/131   1 066000131

6600 M/174

assortment of 13 tools, with hooks without
panel



6600 M/174   1 066000174

6600 M/175

assortment of 12 tools,
with hooks without panel





6600 M/175   1 066000175

6600 M/216

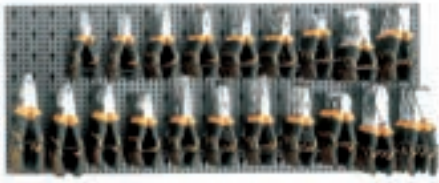
assortment of 80 tools
with hooks without panel





6600 M/216   1 066000216

6600 M/221

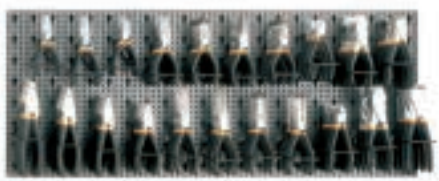
assortment of 83 tools
with hooks without panel



6600 M/221   1 066000221

6600 M/230

assortment of 78 tools,
with hooks without panel



6600 M/230   1 066000230

6600 M/236

assortment of 31 tools,
with hooks without panel





6600 M/236   1 066000236

6600 M/241

assortment of 43 tools,
with hooks without panel





6600 M/241   1 066000241

6600 M/244

assortment of 91 tools
with hooks without panel



6600 M/244   1 066000244

6600 M/311

assortment of 114 tools,
with hooks without panel





6600 M/311   1 066000311

6600 M/315

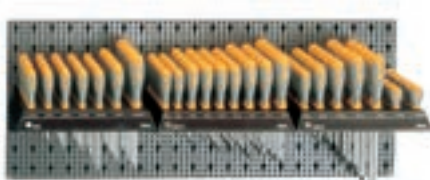
assortment of 149 tools,
with hooks without panel





6600 M/315   1 066000315

6600 M/320

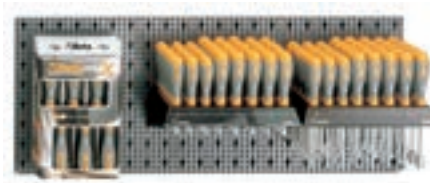
assortment of 98 tools,
with hooks without panel





6600 M/320   1 066000320

6600 M/326

assortment of 155 tools,
with hooks without panel





6600 M/326   1 066000326

6600 M/327

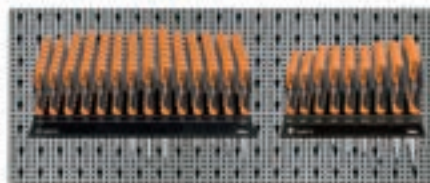
assortment of 101 tools,
with hooks without panel





6600 M/327   1 066000327

6600 M/330

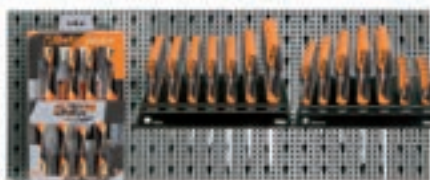
assortment of 110 tools,
with hooks without panel



6600 M/330   1 066000330

6600 M/370

assortment of 162 tools,
with hooks without panel

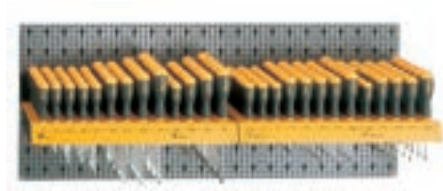

6600 M/370

1 066000370

6600 M/379

assortment of 69 tools,
with hooks without panel



6600 M/379

1 066000379

6600 M/422

assortment of 43 tools, with hooks without panel



6600 M/422

1 066000422

6600 M/423

assortment of 30 tools, with hooks without panel



6600 M/423

1 066000423

6600 M/424

assortment of 36 tools, with hooks without panel



6600 M/424

1 066000424

6600 M/427

assortment of 24 tools,
with hooks without panel



6600 M/427

1 066000427

6600 M/430

assortment of 29 tools,
with hooks without panel



6600 M/430

1 066000430

6600 M/440

assortment of 140 tools,
with hooks without panel

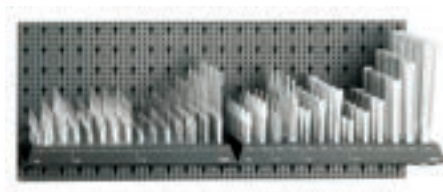

6600 M/440

1 066000440

6600 M/456

assortment of 41 tools,
with hooks without panel



6600 M/456

1 066000456

6600 M/465

assortment of 36 tools, with hooks without panel



6600 M/465

1 066000465

6600 M/480

assortment of 18 tools,
with hooks without panel



6600 M/480

1 066000480

6600 M/485

assortment of 12 tools,
with hooks without panel

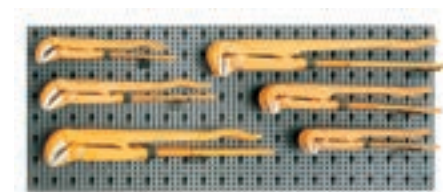



6600 M/485

1 066000485

6600 M/510

assortment of 16 tools,
with hooks without panel





6600 M/510   1 066000510

6600 M/532

assortment of 24 tools
with hooks without panel



6600 M/532   1 066000532

6600 M/534

assortment of 51 tools
with hooks without panel

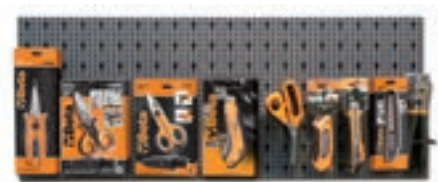



6600 M/534   1 066000534

6600 M/542

assortment of 53 tools,
with hooks without panel





6600 M/542   1 066000542

6600 M/561

assortment of 60 tools,
with hooks without panel





6600 M/561   1 066000561

6600 M/583

assortment of 22 tools
with hooks without panel



6600 M/583   1 066000583

6600 M/608

assortment of 67 tools
with hooks without panel



6600 M/608   1 066000608

6600 M/640

assortment of 90 tools
with hooks without panel





6600 M/640   1 066000640

6600 M/650

assortment of 28 tools,
with hooks without panel





6600 M/650   1 066000650

6600 M/657

assortment of 17 tools,
with hooks without panel





6600 M/657   1 066000657

6600 M/658

assortment of 14 tools
with hooks without panel



6600 M/658   1 066000658

6600 M/716

assortment of 64 tools
with hooks without panel



6600 M/716   1 066000716

6600 M/813

assortment of 25 tools, with hooks without panel



6600 M/813

1 066000813

6600 M/842

assortment of 36 tools, with hooks without panel



6600 M/842

1 066000842

6600 M/851

assortment of 170 abrasives with hooks without panel

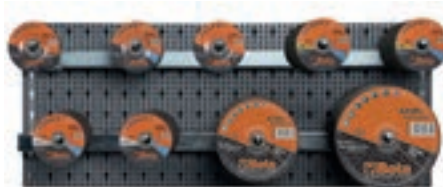

6600 M/851

1 066000851

6600 M/858

assortment of 170 abrasives with hooks without panel



6600 M/858

1 066000858

6600 M/859

assortment of 170 abrasives with hooks without panel



6600 M/859

1 066000859

6600 M/871

assortment of 120 abrasives with hooks without panel



6600 M/871

1 066000871

6600 M/878

assortment of 100 abrasives with hooks without panel



6600 M/878

1 066000878

6600 M/881

assortment of 300 abrasives with display tray



6600 M/881

1 066000881

Robur

8600 R/11

assortment of 374 wire rope accessories, with hooks without panel



8600 R/11

1 086000011

8600 R/12

assortment of 259 wire rope accessories, with hooks without panel



8600 R/12

1 086000012

8600 R/13

assortment of 230 wire rope accessories, with hooks without panel



8600 R/13

1 086000013

8600 R/113

assortment of 1862 wire rope accessories, with hooks without panel



8600 R/113

1 086000113

8600 R/114

assortment of 1045 wire rope accessories, with hooks without panel



8600 R/114 1 086000114

8600 R/225

assortment of 64 GRADE 8 accessories, with hooks without panel



8600 R/225 1 086000225

8600 R/412

assortment of 348 STAINLESS STEEL wire rope accessories, with hooks without panel



8600 R/412 1 086000412

8600 R/511

assortment of 11 Genovese chain reels, with display tray

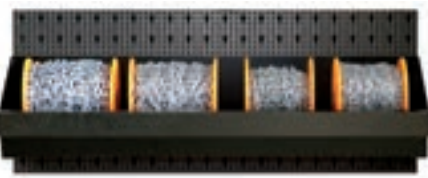

8600 R/511 1 086000511

8600 R/601

assortment of 50 tie down ratchets with grids, shelf and hooks, without panel



8600 R/601 1 086000601
C88/R601 1 088000160

8600 R/611

assortment of 52 webslings with grids, without panel



8600 R/611 1 086000611
C88/R611 1 088000161

8600 E/R1

assortment of 1946 accessories, with hooks without display stand



8600 E/R1 1 086000901

8600 E/R2

assortment of 2349 accessories, with hooks without display stand



8600 E/R2 1 086000902

6600 E/A10

assortment of 527 tools, with hooks without display stand



6600 E/A10 1 066000973

6600 E/A20

assortment of 917 tools
with hooks without display stand



6600 E/A20

1 066000913

6600 E/B10

assortment of 592 tools
with hooks without display stand



6600 E/B10

1 066000971

6600 E/C10

assortment of 309 tools
with hooks without display stand



6600 E/C10

1 066000928

6600 E/A30

assortment of 723 tools
with hooks without display stand



6600 E/A30

1 066000924

6600 E/B20

assortment of 597 tools
with hooks without display stand



6600 E/B20

1 066000972

6600 E/K20

assortment of 377 tools,
with hooks without display stand



6600 E/K20

1 066000982

SAFETY FOOTWEAR

SAFETY STANDARDS

HOW TO CHOOSE SAFETY FOOTWEAR

Make sure that the footwear matches the required protection class, according to type and workplace. Below you will find the European reference standards, including any and all additional specifications.

EN ISO 20344: Test methods and general requirements.

EN ISO 20345: Safety footwear with toe caps resistant to shocks up to 200 Joules.

EN ISO 20346: Protective footwear with toe caps resistant to shocks up to 100 Joules.

EN ISO 20347: Occupational footwear, no toe caps required.

EN ISO 20345 The footwear that complies with this norm is marked with the letter "S" (Safety). The letter "S" is followed by letters and/or numbers indicating the protection class the footwear belongs to.

SB Minimum requirements: 200 Joule toe cap.

Upper made from split leather or the like.

Minimum upper height.

S1 SB characteristics supplemented with the following:

Antistatic footwear (A).

Energy absorption in the heel region (E).

Closed back. (Low shoes as well)

Antislip UNI EN ISO 20345. Method in accordance with EN 13287

S2 S1 characteristics supplemented with the following:

Waterproof upper, no water penetration for at least 1h (WRU).

S3 S2 characteristics supplemented with the following:

Penetration proof insole or inset (P).

Gripped outsole.

S4 S1 characteristics supplemented with the following:

Hydrocarbon proof outsole (ORO).

S5 S4 characteristics supplemented with the following:

Penetration proof insole or inset (P).

Gripped outsole.

EN ISO 20346 These shoes are basically the same as safety footwear. However, since they have 100 Joule toe caps, they are marked with the letter "P" (Protective). Hence they are defined as protective footwear. They are used in workplace environments requiring no more than 100 Joule operation.

EN ISO 20347 These shoes do not have any protective toe caps and are marked with the letter "O" (Occupational); hence they are considered occupational footwear.

Over the years the safety footwear line has gained the most demanding professionals' confidence and preference. These products have been proving so successful as to result in a regularly upgraded and expanded range.

To make it easier to identify both the specifications and the details that suit you best, read the section and icons below.



Penetration proof midsole or inset



Steel, aluminium or plastic toe cap



Antistatic footwear



Energy absorption in the heel region



Oil, hydrocarbon and solvent proof outsole



Antislip outsole



Flexing resistance >60,000



Outsole resistant to hot contact (300 °C/min.)



Shoe with a wide body for enhanced comfort



Nonmagnetic shoe, totally free from metal parts



Shoe designed and developed to allow electrostatic charges to be steadily dissipated from the body to the ground



Shoe designed and developed to provide cold insulation (CI)

WARNINGS

PRELIMINARY CHECKS AND USE

Before using the shoes, visually check their general state – that is, the seams, the sole and the closures –; also make sure that the shoes match all the specifications on the label, and, above all, that they are provided with steel toes and penetration proof steel midsoles.

MISUSE

Prolonged and/or repeated use:

- in contact with organic agents, herbicides, pesticides and highly concentrated acids
- at very low or very high temperatures (below $-10\text{ }^{\circ}\text{C}$ and over $+70\text{ }^{\circ}\text{C}$)
- fully dipped into water, mud, mortar and alike is not recommended.

EASY



7241EN

leather shoe, water-repellent

- Steel toe cap
- Elastic steel penetration proof insole

EU	UK	
35	2,5	1 072410835
36	3,5	1 072410836
37	4,5	1 072410837
38	5	1 072410838
39	6	1 072410839
40	6,5	1 072410840
41	7	1 072410841
42	8	1 072410842
43	9	1 072410843
44	10	1 072410844
45	10,5	1 072410845
46	11	1 072410846
47	12	1 072410847
48	13	1 072410848



CE

S3 SRC



7243EN

leather ankle shoe, water-repellent,
with quick opening system

- Steel toe cap
- Elastic steel penetration proof insole

EU	UK	
35	2,5	1 072430835
36	3,5	1 072430836
37	4,5	1 072430837
38	5	1 072430838
39	6	1 072430839
40	6,5	1 072430840
41	7	1 072430841
42	8	1 072430842
43	9	1 072430843
44	10	1 072430844
45	10,5	1 072430845
46	11	1 072430846
47	12	1 072430847
48	13	1 072430848



CE

S3 RS SRC



7246E

suede shoe, perforated

- Steel toe cap
- Elastic steel penetration proof insole

EU	UK	
35	2,5	1 072460435
36	3,5	1 072460436
37	4,5	1 072460437
38	5	1 072460438
39	6	1 072460439
40	6,5	1 072460440
41	7	1 072460441
42	8	1 072460442
43	9	1 072460443
44	10	1 072460444
45	10,5	1 072460445
46	11	1 072460446
47	12	1 072460447
48	13	1 072460448



CE

S1P SRC



BASIC



7239C

leather ankle boot, water-repellent, with cold insulation membrane and reinforcement polyurethane toe cap cover

- Steel toe cap
- Elastic steel penetration proof insole

EU	UK		
35	2,5	1	072390235
36	3,5	1	072390236
37	4,5	1	072390237
38	5	1	072390238
39	6	1	072390239
40	6,5	1	072390240
41	7	1	072390241
42	8	1	072390242
43	9	1	072390243
44	10	1	072390244
45	10,5	1	072390245
46	11	1	072390246
47	12	1	072390247
48	13	1	072390248



CE

S3 CI SRC

EN ISO
20345
2011



7241BK

leather shoe

- Steel toe cap
- Composite fibre penetration proof insole

EU	UK		
35	2,5	1	072411235
36	3,5	1	072411236
37	4,5	1	072411237
38	5	1	072411238
39	6	1	072411239
40	6,5	1	072411240
41	7	1	072411241
42	8	1	072411242
43	9	1	072411243
44	10	1	072411244
45	10,5	1	072411245
46	11	1	072411246
47	12	1	072411247
48	13	1	072411248



CE

S1P SRC

EN ISO
20345
2011



7241CK

leather shoe, water-repellent

- Steel toe cap
- Composite fibre penetration proof insole

EU	UK		
35	2,5	1	072411535
36	3,5	1	072411536
37	4,5	1	072411537
38	5	1	072411538
39	6	1	072411539
40	6,5	1	072411540
41	7	1	072411541
42	8	1	072411542
43	9	1	072411543
44	10	1	072411544
45	10,5	1	072411545
46	11	1	072411546
47	12	1	072411547
48	13	1	072411548



CE

S3 SRC

EN ISO
20345
2011



7241FT

leather shoe, waterproof,
without toe cap and penetration proof insole

- Without toe cap
- Without penetration proof insole



EU	UK	1	2
35	2,5	1	072410635
36	3,5	1	072410636
37	4,5	1	072410637
38	5	1	072410638
39	6	1	072410639
40	6,5	1	072410640
41	7	1	072410641
42	8	1	072410642
43	9	1	072410643
44	10	1	072410644
45	10,5	1	072410645
46	11	1	072410646
47	12	1	072410647
48	13	1	072410648



CE

O2 FO SRC

EN ISO
20347
2012



7243BK

leather ankle shoe

- Steel toe cap
- Composite fibre penetration proof insole

EU	UK	1	2
35	2,5	1	072431235
36	3,5	1	072431236
37	4,5	1	072431237
38	5	1	072431238
39	6	1	072431239
40	6,5	1	072431240
41	7	1	072431241
42	8	1	072431242
43	9	1	072431243
44	10	1	072431244
45	10,5	1	072431245
46	11	1	072431246
47	12	1	072431247
48	13	1	072431248



CE

S1P SRC

EN ISO
20345
2011



7243CK

leather ankle shoe, water-repellent,
with quick opening system

- Steel toe cap
- Composite fibre penetration proof insole

EU	UK	1	2
35	2,5	1	072431335
36	3,5	1	072431336
37	4,5	1	072431337
38	5	1	072431338
39	6	1	072431339
40	6,5	1	072431340
41	7	1	072431341
42	8	1	072431342
43	9	1	072431343
44	10	1	072431344
45	10,5	1	072431345
46	11	1	072431346
47	12	1	072431347
48	13	1	072431348



CE

S3 RS SRC

EN ISO
20345
2011



7243CR

leather ankle shoe, waterproof,
with durable rubber outsole
and quick opening system

- Steel toe cap
- Elastic steel penetration-proof insole

EU	UK	1	2
35	2,5	1	072430735
36	3,5	1	072430736
37	4,5	1	072430737
38	5	1	072430738
39	6	1	072430739
40	6,5	1	072430740
41	7	1	072430741
42	8	1	072430742
43	9	1	072430743
44	10	1	072430744
45	10,5	1	072430745
46	11	1	072430746
47	12	1	072430747
48	13	1	072430748



CE

S3 RS HRO SRC

EN ISO
20345
2011



7243FT

leather ankle shoe, waterproof,
without toe cap and penetration proof insole

- Without toe cap
- Without penetration proof insole

EU	UK		
35	2,5	1	072430635
36	3,5	1	072430636
37	4,5	1	072430637
38	5	1	072430638
39	6	1	072430639
40	6,5	1	072430640
41	7	1	072430641
42	8	1	072430642
43	9	1	072430643
44	10	1	072430644
45	10,5	1	072430645
46	11	1	072430646
47	12	1	072430647
48	13	1	072430648



CE

O2 FO SRC



7245BK

lace-up leather ankle shoe, "welder" style, water-repellent, with
quick opening system
and front protection with strap closure

- Steel toe cap
- Composite fibre penetration proof insole

EU	UK		
35	2,5	1	072451235
36	3,5	1	072451236
37	4,5	1	072451237
38	5	1	072451238
39	6	1	072451239
40	6,5	1	072451240
41	7	1	072451241
42	8	1	072451242
43	9	1	072451243
44	10	1	072451244
45	10,5	1	072451245
46	11	1	072451246
47	12	1	072451247
48	13	1	072451248



CE

S3 RS SRC



7246BK

suede shoe, perforated

- Steel toe cap
- Composite fibre penetration proof insole

EU	UK		
35	2,5	1	072461235
36	3,5	1	072461236
37	4,5	1	072461237
38	5	1	072461238
39	6	1	072461239
40	6,5	1	072461240
41	7	1	072461241
42	8	1	072461242
43	9	1	072461243
44	10	1	072461244
45	10,5	1	072461245
46	11	1	072461246
47	12	1	072461247
48	13	1	072461248



CE

S1P SRC



7247BK

leather sandal, perforated

- Steel toe cap
- Composite fibre penetration proof insole

EU	UK		
35	2,5	1	072471235
36	3,5	1	072471236
37	4,5	1	072471237
38	5	1	072471238
39	6	1	072471239
40	6,5	1	072471240
41	7	1	072471241
42	8	1	072471242
43	9	1	072471243
44	10	1	072471244
45	10,5	1	072471245
46	11	1	072471246
47	12	1	072471247
48	13	1	072471248



CE

S1P SRC



7328EA

safety boot, "Top Visibility"

- Steel toe cap
- Stainless steel penetration proof insole

EU	UK		
38	5	1	073280538
39	6	1	073280539
40	6,5	1	073280540
41	7	1	073280541
42	8	1	073280542
43	9	1	073280543
44	10	1	073280544
45	10,5	1	073280545
46	11	1	073280546
47	12	1	073280547

CE



S5 SRC



7328EN

safety boot

- Steel toe cap
- Stainless steel penetration proof insole

EU	UK		
38	5	1	073280738
39	6	1	073280739
40	6,5	1	073280740
41	7	1	073280741
42	8	1	073280742
43	9	1	073280743
44	10	1	073280744
45	10,5	1	073280745
46	11	1	073280746
47	12	1	073280747

CE



S5 SRC



EASY PLUS



7220PEK

leather shoe, water-repellent, with nylon inserts and anti-abrasion reinforcement in toe cap area

- Composite toe cap
- Composite fibre penetration proof insole

EU	UK		
35	2,5	1	072200235
36	3,5	1	072200236
37	4,5	1	072200237
38	5	1	072200238
39	6	1	072200239
40	6,5	1	072200240
41	7	1	072200241
42	8	1	072200242
43	9	1	072200243
44	10	1	072200244
45	10,5	1	072200245
46	11	1	072200246
47	12	1	072200247
48	13	1	072200248

CE



S3 SRC



7221PEK

leather ankle shoe, water-repellent, with nylon inserts, anti-abrasion reinforcement in toe cap area and quick opening system

- Composite toe cap
- Composite fibre penetration proof insole

EU	UK	1	072210235
35	2,5	1	072210235
36	3,5	1	072210236
37	4,5	1	072210237
38	5	1	072210238
39	6	1	072210239
40	6,5	1	072210240
41	7	1	072210241
42	8	1	072210242
43	9	1	072210243
44	10	1	072210244
45	10,5	1	072210245
46	11	1	072210246
47	12	1	072210247
48	13	1	072210248

CE



S3 RS SRC



7223PEK

suede shoe with highly breathable mesh inserts and anti-abrasion reinforcement in toe cap area

- Composite toe cap
- Composite fibre penetration proof insole

EU	UK	1	072230135
35	2,5	1	072230135
36	3,5	1	072230136
37	4,5	1	072230137
38	5	1	072230138
39	6	1	072230139
40	6,5	1	072230140
41	7	1	072230141
42	8	1	072230142
43	9	1	072230143
44	10	1	072230144
45	10,5	1	072230145
46	11	1	072230146
47	12	1	072230147
48	13	1	072230148

CE



S1P SRC



7224PEK

suede shoe, perforated, with anti-abrasion reinforcement in toe cap area

- Composite toe cap
- Composite fibre penetration proof insole

EU	UK	1	072240235
35	2,5	1	072240235
36	3,5	1	072240236
37	4,5	1	072240237
38	5	1	072240238
39	6	1	072240239
40	6,5	1	072240240
41	7	1	072240241
42	8	1	072240242
43	9	1	072240243
44	10	1	072240244
45	10,5	1	072240245
46	11	1	072240246
47	12	1	072240247
48	13	1	072240248

CE



S1P SRC



 **Beta**

FLEX



7212FG

suede shoe, perforated,
with anti-abrasion insert in toe cap area
Extremely flexible and lightweight - approximate weight, size 42: 490 g
Not recommended for heavy-duty use (building, agriculture, heavy industry)

EU	UK		
35	2,5	1	072120035
36	3,5	1	072120036
37	4,5	1	072120037
38	5	1	072120038
39	6	1	072120039
40	6,5	1	072120040
41	7	1	072120041
42	8	1	072120042
43	9	1	072120043
44	10	1	072120044
45	10,5	1	072120045
46	11	1	072120046
47	12	1	072120047
48	13	1	072120048

- Composite toe cap
- Composite fibre penetration-proof insole



CE

S1P SRC

EN ISO 20345 2011



7212LG

women's suede shoe, perforated, with mesh inserts
Extremely flexible and lightweight - approximate weight, size 38: 380 g
Not recommended for heavy-duty use (building, agriculture, heavy industry)

EU	UK		
34	2	1	072120134
35	2,5	1	072120135
36	3,5	1	072120136
37	4,5	1	072120137
38	5	1	072120138
39	6	1	072120139
40	6,5	1	072120140
41	7	1	072120141
42	8	1	072120142

- Composite toe cap
- Composite fibre penetration-proof insole



CE

S1P SRC

EN ISO 20345 2011



7213FG

suede shoe with highly breathable mesh inserts
Extremely flexible and lightweight - approximate weight, size 42: 490 g
Not recommended for heavy-duty use (building, agriculture, heavy industry)

EU	UK		
35	2,5	1	072130035
36	3,5	1	072130036
37	4,5	1	072130037
38	5	1	072130038
39	6	1	072130039
40	6,5	1	072130040
41	7	1	072130041
42	8	1	072130042
43	9	1	072130043
44	10	1	072130044
45	10,5	1	072130045
46	11	1	072130046
47	12	1	072130047
48	13	1	072130048

- Composite toe cap
- Composite fibre penetration-proof insole



CE

S1P SRC

EN ISO 20345 2011



7214FN

Action nubuck shoe, waterproof, with anti-abrasion insert in toe cap area
Extremely flexible and lightweight - approximate weight size 42: 500 g
Not recommended for heavy-duty use (building, agriculture, heavy industry)

- Composite toe cap
- Composite fibre penetration-proof insole

EU	UK		
35	2,5	1	072140035
36	3,5	1	072140036
37	4,5	1	072140037
38	5	1	072140038
39	6	1	072140039
40	6,5	1	072140040
41	7	1	072140041
42	8	1	072140042
43	9	1	072140043
44	10	1	072140044
45	10,5	1	072140045
46	11	1	072140046
47	12	1	072140047
48	13	1	072140048

CE



S3 SRC



7214LN

women's suede shoe, waterproof, with anti-abrasion insert in toe cap area
Extremely flexible and lightweight - approximate weight, size 38: 380 g
Not recommended for heavy-duty use (building, agriculture, heavy industry)

- Composite toe cap
- Composite fibre penetration-proof insole

EU	UK		
34	2	1	072140134
35	2,5	1	072140135
36	3,5	1	072140136
37	4,5	1	072140137
38	5	1	072140138
39	6	1	072140139
40	6,5	1	072140140
41	7	1	072140141
42	8	1	072140142

CE



S3 SRC



7215FN

Action nubuck moccasin, waterproof, with anti-abrasion insert in toe cap area
Extremely flexible and lightweight - approximate weight, size 42: 490 g
Not recommended for heavy-duty use (building, agriculture, heavy industry)

- Composite toe cap
- Composite fibre penetration-proof insole

EU	UK		
35	2,5	1	072150135
36	3,5	1	072150136
37	4,5	1	072150137
38	5	1	072150138
39	6	1	072150139
40	6,5	1	072150140
41	7	1	072150141
42	8	1	072150142
43	9	1	072150143
44	10	1	072150144
45	10,5	1	072150145
46	11	1	072150146
47	12	1	072150147
48	13	1	072150148

CE



S3 SRC



7217FB

mesh shoe, highly breathable, with anti-abrasion insert in toe cap area
Extremely flexible and lightweight - approximate weight, size 42: 490 g
Not recommended for heavy-duty jobs (building, agriculture, heavy industry)

- Composite toe cap
- Composite fibre penetration-proof insole

EU	UK		
35	2,5	1	072170135
36	3,5	1	072170136
37	4,5	1	072170137
38	5	1	072170138
39	6	1	072170139
40	6,5	1	072170140
41	7	1	072170141
42	8	1	072170142
43	9	1	072170143
44	10	1	072170144
45	10,5	1	072170145
46	11	1	072170146
47	12	1	072170147
48	13	1	072170148

CE



S1P SRC



7217FG

mesh shoe, highly breathable, with anti-abrasion insert in toe cap area Extremely flexible and lightweight - approximate weight, size 42: 490 g

Not recommended for heavy-duty jobs (building, agriculture, heavy industry)

EU	UK		
35	2,5	1	072170235
36	3,5	1	072170236
37	4,5	1	072170237
38	5	1	072170238
39	6	1	072170239
40	6,5	1	072170240
41	7	1	072170241
42	8	1	072170242
43	9	1	072170243
44	10	1	072170244
45	10,5	1	072170245
46	11	1	072170246
47	12	1	072170247
48	13	1	072170248

- Composite toe cap
- Composite fibre penetration-proof insole



S1P SRC



7218FN

Action nubuck ankle shoe, water-repellent, with anti-abrasion insert in toe cap area and quick opening system Extremely flexible and lightweight - approximate weight, size 42: 510 g Not recommended for heavy-duty use (building, agriculture, heavy industry)

EU	UK		
35	2,5	1	072180035
36	3,5	1	072180036
37	4,5	1	072180037
38	5	1	072180038
39	6	1	072180039
40	6,5	1	072180040
41	7	1	072180041
42	8	1	072180042
43	9	1	072180043
44	10	1	072180044
45	10,5	1	072180045
46	11	1	072180046
47	12	1	072180047
48	13	1	072180048

- Composite toe cap
- Composite fibre penetration proof insole



CE

S3 RS SRC



7219FY

microfibre shoe, waterproof, with anti-abrasion insert in toe cap area Extremely flexible and lightweight - approximate weight, size 42: 490 g Not recommended for heavy-duty jobs (building, agriculture, heavy industry)

EU	UK		
35	2,5	1	072190035
36	3,5	1	072190036
37	4,5	1	072190037
38	5	1	072190038
39	6	1	072190039
40	6,5	1	072190040
41	7	1	072190041
42	8	1	072190042
43	9	1	072190043
44	10	1	072190044
45	10,5	1	072190045
46	11	1	072190046
47	12	1	072190047
48	13	1	072190048

- Composite toe cap
- Composite fibre penetration-proof insole



S3 SRC



BASIC PLUS



7200BKK

full-grain leather shoe, waterproof

- Composite toe cap
- Composite fibre penetration proof insole

EU	UK	Art. No.
35	2,5	1 072000235
36	3,5	1 072000236
37	4,5	1 072000237
38	5	1 072000238
39	6	1 072000239
40	6,5	1 072000240
41	7	1 072000241
42	8	1 072000242
43	9	1 072000243
44	10	1 072000244
45	10,5	1 072000245
46	11	1 072000246
47	12	1 072000247
48	13	1 072000248



CE

S3 SRC



7201BKK

full-grain leather ankle shoe, waterproof

- Composite toe cap
- Composite fibre penetration proof insole

EU	UK	Art. No.
35	2,5	1 072010435
36	3,5	1 072010436
37	4,5	1 072010437
38	5	1 072010438
39	6	1 072010439
40	6,5	1 072010440
41	7	1 072010441
42	8	1 072010442
43	9	1 072010443
44	10	1 072010444
45	10,5	1 072010445
46	11	1 072010446
47	12	1 072010447
48	13	1 072010448



CE

S3 SRC



7210BKK

soft suede shoe, perforated

- Composite toe cap
- Composite fibre penetration proof insole

EU	UK	Art. No.
35	2,5	1 072100335
36	3,5	1 072100336
37	4,5	1 072100337
38	5	1 072100338
39	6	1 072100339
40	6,5	1 072100340
41	7	1 072100341
42	8	1 072100342
43	9	1 072100343
44	10	1 072100344
45	10,5	1 072100345
46	11	1 072100346
47	12	1 072100347
48	13	1 072100348



CE

S1P SRC

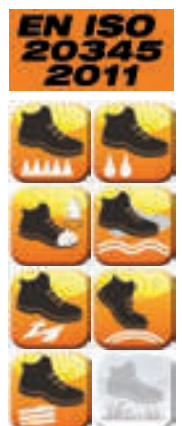

7210PB

suede shoe, perforated

- Composite toe cap
- Composite fibre penetration proof insole

EU	UK		
35	2,5	1	072100435
36	3,5	1	072100436
37	4,5	1	072100437
38	5	1	072100438
39	6	1	072100439
40	6,5	1	072100440
41	7	1	072100441
42	8	1	072100442
43	9	1	072100443
44	10	1	072100444
45	10,5	1	072100445
46	11	1	072100446
47	12	1	072100447
48	13	1	072100448

CE



EN ISO 20345 2011



S1P SRC

7211PG

suede shoe, perforated

- Composite toe cap
- Composite fibre penetration proof insole

EU	UK		
35	2,5	1	072110435
36	3,5	1	072110436
37	4,5	1	072110437
38	5	1	072110438
39	6	1	072110439
40	6,5	1	072110440
41	7	1	072110441
42	8	1	072110442
43	9	1	072110443
44	10	1	072110444
45	10,5	1	072110445
46	11	1	072110446
47	12	1	072110447
48	13	1	072110448

CE



EN ISO 20345 2011



S1P SRC

7216BKK

soft suede sandal, with strap closure

- Composite toe cap
- Composite fibre penetration proof insole

EU	UK		
35	2,5	1	072160335
36	3,5	1	072160336
37	4,5	1	072160337
38	5	1	072160338
39	6	1	072160339
40	6,5	1	072160340
41	7	1	072160341
42	8	1	072160342
43	9	1	072160343
44	10	1	072160344
45	10,5	1	072160345
46	11	1	072160346
47	12	1	072160347
48	13	1	072160348

CE



EN ISO 20345 2011



S1P SRC

7310CRK

lace-up black leather shoe, "welder" style, water-repellent, with quick opening system and front protection with strap fastening and flameproof seams Hard-wearing rubber outsole and anti-abrasion insert in toe cap area

- Composite toe cap
- Composite fibre penetration proof insole

EU	UK		
35	2,5	1	073100335
36	3,5	1	073100336
37	4,5	1	073100337
38	5	1	073100338
39	6	1	073100339
40	6,5	1	073100340
41	7	1	073100341
42	8	1	073100342
43	9	1	073100343
44	10	1	073100344
45	10,5	1	073100345
46	11	1	073100346
47	12	1	073100347
48	13	1	073100348

CE



EN ISO 20345 2011



S3 RS HRO SRC

TREKKING

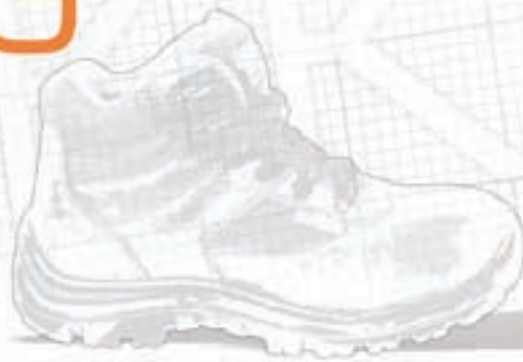

7235BK

Action Nubuck shoe, waterproof, with reinforcement polyurethane toe cap cover

- Steel toe cap
- Composite fibre penetration-proof insole

EU	UK		
35	2,5	1	072350335
36	3,5	1	072350336
37	4,5	1	072350337
38	5	1	072350338
39	6	1	072350339
40	6,5	1	072350340
41	7	1	072350341
42	8	1	072350342
43	9	1	072350343
44	10	1	072350344
45	10,5	1	072350345
46	11	1	072350346
47	12	1	072350347
48	13	1	072350348



CE

S3 SRC

EN ISO
20345
2011



7236BK

Action Nubuck ankle shoe, waterproof, with quick opening system and reinforcement polyurethane toe cap cover

- Steel toe cap
- Composite fibre penetration-proof insole

EU	UK		
35	2,5	1	072360335
36	3,5	1	072360336
37	4,5	1	072360337
38	5	1	072360338
39	6	1	072360339
40	6,5	1	072360340
41	7	1	072360341
42	8	1	072360342
43	9	1	072360343
44	10	1	072360344
45	10,5	1	072360345
46	11	1	072360346
47	12	1	072360347
48	13	1	072360348



CE

S3 RS SRC

EN ISO
20345
2011



7237WR

suede ankle shoe with nylon inserts, durable rubber outsole and quick opening system
WR (water-resistant) footwear: after 1,000 steps in a tank with 3 cm of water, the wet internal surface has to be ≤ 3 cm² (spot)

- Composite toe cap
- Composite fibre penetration-proof insole

EU	UK		
35	2,5	1	072370235
36	3,5	1	072370236
37	4,5	1	072370237
38	5	1	072370238
39	6	1	072370239
40	6,5	1	072370240
41	7	1	072370241
42	8	1	072370242
43	9	1	072370243
44	10	1	072370244
45	10,5	1	072370245
46	11	1	072370246
47	12	1	072370247
48	13	1	072370248



CE

Endurance

S3 RS WR HRO SRC

EN ISO
20345
2011



7238WR

suede ankle shoe with nylon inserts,

durable rubber outsole and quick opening system

WR (water-resistant) footwear: after 1,000 steps in a tank with 3 cm of water, the wet internal surface has to be ≤ 3 cm² (spot)

- Composite toe cap
- Composite fibre penetration-proof insole

EU	UK		
35	2,5	1	072380235
36	3,5	1	072380236
37	4,5	1	072380237
38	5	1	072380238
39	6	1	072380239
40	6,5	1	072380240
41	7	1	072380241
42	8	1	072380242
43	9	1	072380243
44	10	1	072380244
45	10,5	1	072380245
46	11	1	072380246
47	12	1	072380247
48	13	1	072380248

CE



ENDURANCE

S3 RS WR HRO SRC

EN ISO 20345 2011



7248GK

suede shoe with nylon inserts and reinforcement polyurethane toe cap cover

- Steel toe cap
- Composite fibre penetration-proof insole

EU	UK		
35	2,5	1	072480235
36	3,5	1	072480236
37	4,5	1	072480237
38	5	1	072480238
39	6	1	072480239
40	6,5	1	072480240
41	7	1	072480241
42	8	1	072480242
43	9	1	072480243
44	10	1	072480244
45	10,5	1	072480245
46	11	1	072480246
47	12	1	072480247
48	13	1	072480248

CE



S1P SRC

EN ISO 20345 2011



7249GK

suede ankle shoe with nylon inserts, quick opening system and reinforcement polyurethane toe cap cover

- Steel toe cap
- Composite fibre penetration-proof insole

EU	UK		
35	2,5	1	072490235
36	3,5	1	072490236
37	4,5	1	072490237
38	5	1	072490238
39	6	1	072490239
40	6,5	1	072490240
41	7	1	072490241
42	8	1	072490242
43	9	1	072490243
44	10	1	072490244
45	10,5	1	072490245
46	11	1	072490246
47	12	1	072490247
48	13	1	072490248

CE



S1P RS SRC

EN ISO 20345 2011



 **Beta**

SNEAKERS



7252NKK

Nubuck ankle shoe, waterproof, with waterproof microfibre inserts

- Composite toe cap with breathable membrane
- Composite fibre penetration proof insole

EU	UK		
38	5	1	072520138
39	6	1	072520139
40	6,5	1	072520140
41	7	1	072520141
42	8	1	072520142
43	9	1	072520143
44	10	1	072520144
45	10,5	1	072520145
46	11	1	072520146
47	12	1	072520147

CE



Zolder



EN ISO 20345 2011



S3 SRC

7253NKK

Nubuck ankle shoe, waterproof, with waterproof microfibre inserts

- Composite toe cap
- Composite fibre penetration proof insole

EU	UK		
38	5	1	072530138
39	6	1	072530139
40	6,5	1	072530140
41	7	1	072530141
42	8	1	072530142
43	9	1	072530143
44	10	1	072530144
45	10,5	1	072530145
46	11	1	072530146
47	12	1	072530147

CE



Zolder



EN ISO 20345 2011



S3 SRC

7313B

suede shoe with nylon mesh and PU inserts

- Fibreglass toe cap
- Composite fibre penetration proof insole

EU	UK		
35	2,5	1	073130835
36	3,5	1	073130836
37	4,5	1	073130837
38	5	1	073130838
39	6	1	073130839
40	6,5	1	073130840
41	7	1	073130841
42	8	1	073130842
43	9	1	073130843
44	10	1	073130844
45	10,5	1	073130845
46	11	1	073130846
47	12	1	073130847
48	13	1	073130848

CE



Monza



EN ISO 20345 2011



S1P SRC

7313G

suede shoe
with nylon mesh and PU inserts

- Fibreglass toe cap
- Composite fibre penetration proof insole

EU	UK	IT	FR
35	2,5	1	073130635
36	3,5	1	073130636
37	4,5	1	073130637
38	5	1	073130638
39	6	1	073130639
40	6,5	1	073130640
41	7	1	073130641
42	8	1	073130642
43	9	1	073130643
44	10	1	073130644
45	10,5	1	073130645
46	11	1	073130646
47	12	1	073130647
48	13	1	073130648



Monza



CE

S1P SRC



7314AF

suede shoe
with nylon mesh and carbon inserts

- Composite toe cap
- Composite fibre penetration proof insole

EU	UK	IT	FR
35	2,5	1	073140235
36	3,5	1	073140236
37	4,5	1	073140237
38	5	1	073140238
39	6	1	073140239
40	6,5	1	073140240
41	7	1	073140241
42	8	1	073140242
43	9	1	073140243
44	10	1	073140244
45	10,5	1	073140245
46	11	1	073140246
47	12	1	073140247
48	13	1	073140248



Active



CE

S1P SRC



7314AB

suede shoe
with nylon mesh and carbon inserts

- Composite toe cap
- Composite fibre penetration proof insole

EU	UK	IT	FR
35	2,5	1	073140335
36	3,5	1	073140336
37	4,5	1	073140337
38	5	1	073140338
39	6	1	073140339
40	6,5	1	073140340
41	7	1	073140341
42	8	1	073140342
43	9	1	073140343
44	10	1	073140344
45	10,5	1	073140345
46	11	1	073140346
47	12	1	073140347
48	13	1	073140348



Active



CE

S1P SRC



7316N

suede shoe, waterproof,
with microfibre insert

- Fibreglass toe cap
- Composite fibre penetration proof insole

EU	UK	IT	FR
35	2,5	1	073160535
36	3,5	1	073160536
37	4,5	1	073160537
38	5	1	073160538
39	6	1	073160539
40	6,5	1	073160540
41	7	1	073160541
42	8	1	073160542
43	9	1	073160543
44	10	1	073160544
45	10,5	1	073160545
46	11	1	073160546
47	12	1	073160547
48	13	1	073160548



Assen



CE

S3 SRC



7315AN

suede and microfibre shoe,
water-repellent, with carbon inserts

- Composite toe cap
- Composite fibre penetration proof insole

EU	UK		
35	2,5	1	073150535
36	3,5	1	073150536
37	4,5	1	073150537
38	5	1	073150538
39	6	1	073150539
40	6,5	1	073150540
41	7	1	073150541
42	8	1	073150542
43	9	1	073150543
44	10	1	073150544
45	10,5	1	073150545
46	11	1	073150546
47	12	1	073150547
48	13	1	073150548



CE

S3 SRC



7318AN

suede and microfibre ankle shoe,
water-repellent, with carbon inserts

- Composite toe cap
- Composite fibre penetration proof insole

EU	UK		
35	2,5	1	073180535
36	3,5	1	073180536
37	4,5	1	073180537
38	5	1	073180538
39	6	1	073180539
40	6,5	1	073180540
41	7	1	073180541
42	8	1	073180542
43	9	1	073180543
44	10	1	073180544
45	10,5	1	073180545
46	11	1	073180546
47	12	1	073180547
48	13	1	073180548



CE

S3 SRC



O-GRAVITY

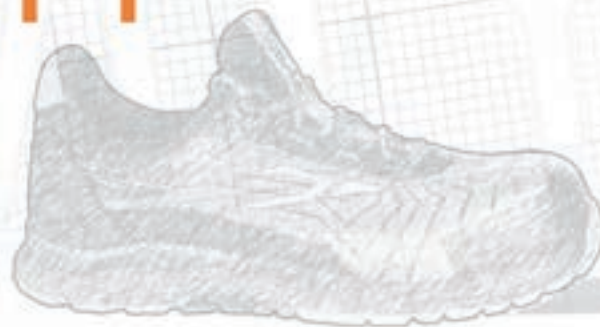

7352A

mesh fabric shoe, highly breathable, with TPU inserts
Heel stability support, stretch slip-on collar
and EVA outsole with durable nitrile rubber tread

- Composite toe cap
- Composite fibre penetration-proof insole
- **REMARKABLY LIGHTWEIGHT:** approximate weight,
size 42: 450 g

EU	UK		
38	5	1	073520038
39	6	1	073520039
40	6,5	1	073520040
41	7	1	073520041
42	8	1	073520042
43	9	1	073520043
44	10	1	073520044
45	10,5	1	073520045
46	11	1	073520046
47	12	1	073520047
48	13	1	073520048



CE

S1P HRO SRC



7352B

mesh fabric shoe, highly breathable, with TPU inserts
Heel stability support, stretch slip-on collar
and EVA outsole with durable nitrile rubber tread

- Composite toe cap
- Composite fibre penetration-proof insole
- **REMARKABLY LIGHTWEIGHT:** approximate weight, size 42: 450 g



S1P HRO SRC



EU	UK		
38	5	1	073520138
39	6	1	073520139
40	6,5	1	073520140
41	7	1	073520141
42	8	1	073520142
43	9	1	073520143
44	10	1	073520144
45	10,5	1	073520145
46	11	1	073520146
47	12	1	073520147
48	13	1	073520148



7353Y

mesh fabric shoe, highly breathable, with TPU inserts
High-visibility reflective mesh upper
Heel stability support, stretch slip-on collar and EVA outsole
with durable nitrile rubber tread

- Carbon fibre toe cap
- Composite fibre penetration-proof insole
- **REMARKABLY LIGHTWEIGHT:** approximate weight, size 42: 420 g



S1P HRO SRC



EU	UK		
38	5	1	073530038
39	6	1	073530039
40	6,5	1	073530040
41	7	1	073530041
42	8	1	073530042
43	9	1	073530043
44	10	1	073530044
45	10,5	1	073530045
46	11	1	073530046
47	12	1	073530047
48	13	1	073530048



7354N

mesh fabric shoe, waterproof, with TPU inserts
Heel stability support, stretch slip-on collar and EVA outsole
with durable nitrile rubber tread

- Composite toe cap
- Composite fibre penetration-proof insole
- **REMARKABLY LIGHTWEIGHT:** approximate weight for size 42: 460 g



S3 HRO SRC



EU	UK		
38	5	1	073540038
39	6	1	073540039
40	6,5	1	073540040
41	7	1	073540041
42	8	1	073540042
43	9	1	073540043
44	10	1	073540044
45	10,5	1	073540045
46	11	1	073540046
47	12	1	073540047
48	13	1	073540048



7355V

mesh fabric ankle shoe, waterproof, with TPU inserts
Heel stability support, stretch slip-on collar and EVA outsole
with durable nitrile rubber tread

- Composite toe cap
- Composite fibre penetration-proof insole
- **REMARKABLY LIGHTWEIGHT:** approximate weight for size 42: 465 g



S3 HRO SRC



EU	UK		
38	5	1	073550038
39	6	1	073550039
40	6,5	1	073550040
41	7	1	073550041
42	8	1	073550042
43	9	1	073550043
44	10	1	073550044
45	10,5	1	073550045
46	11	1	073550046
47	12	1	073550047
48	13	1	073550048



SNEAKERS PRO



7340B

mesh fabric shoe, highly breathable, with high-frequency PU inserts and protective toe cap reinforcement made of crust suede. Extremely lightweight - approximate weight, size 42: 470 g

- Aluminium toe cap
- Composite fibre penetration-proof insole
- FixLock closing makes it easier to put and remove the shoe (traditional laces included)

EU	UK	1	2
36	3,5	1	073400236
37	4,5	1	073400237
38	5	1	073400238
39	6	1	073400239
40	6,5	1	073400240
41	7	1	073400241
42	8	1	073400242
43	9	1	073400243
44	10	1	073400244
45	10,5	1	073400245
46	11	1	073400246
47	12	1	073400247



FIT PRO NET

CE

S1P SRC

EN ISO 20345 2011



7340R

mesh fabric shoe, highly breathable, with high-frequency PU inserts and protective toe cap reinforcement made of crust suede. Extremely lightweight - approximate weight, size 42: 470 g

- Aluminium toe cap
- Composite fibre penetration-proof insole
- FixLock closing makes it easier to put and remove the shoe (traditional laces included)

EU	UK	1	2
36	3,5	1	073400436
37	4,5	1	073400437
38	5	1	073400438
39	6	1	073400439
40	6,5	1	073400440
41	7	1	073400441
42	8	1	073400442
43	9	1	073400443
44	10	1	073400444
45	10,5	1	073400445
46	11	1	073400446
47	12	1	073400447



FIT PRO NET

CE

S1P SRC

EN ISO 20345 2011



7341N

microsuede shoe, waterproof, with high-frequency PU inserts and protective toe cap reinforcement made of crust suede. Extremely lightweight - approximate weight, size 42: 470 g

- Aluminium toe cap
- Composite fibre penetration-proof insole
- FixLock closing makes it easier to put and remove the shoe (traditional laces included)

EU	UK	1	2
36	3,5	1	073410236
37	4,5	1	073410237
38	5	1	073410238
39	6	1	073410239
40	6,5	1	073410240
41	7	1	073410241
42	8	1	073410242
43	9	1	073410243
44	10	1	073410244
45	10,5	1	073410245
46	11	1	073410246
47	12	1	073410247



FIT PRO

CE

S3 SRC

EN ISO 20345 2011



7349RP

shoe made of Nubuck crust leather, waterproof with rubber outsole and soft PU ring

- Composite toe cap
- Composite fibre penetration proof insole

EU	UK		
38	5	1	073490138
39	6	1	073490139
40	6,5	1	073490140
41	7	1	073490141
42	8	1	073490142
43	9	1	073490143
44	10	1	073490144
45	10,5	1	073490145
46	11	1	073490146
47	12	1	073490147

CE



EN ISO 20345 2011



S3 HRO SRC

7350RP

ankle shoe made of Nubuck crust leather, waterproof with rubber outsole and soft PU ring

- Composite toe cap
- Composite fibre penetration proof insole

EU	UK		
38	5	1	073500138
39	6	1	073500139
40	6,5	1	073500140
41	7	1	073500141
42	8	1	073500142
43	9	1	073500143
44	10	1	073500144
45	10,5	1	073500145
46	11	1	073500146
47	12	1	073500147

CE



EN ISO 20345 2011



S3 HRO SRC

MANAGER



7290NA

full-grain leather shoe, waterproof, with reinforcement polyurethane toe cap cover and PU/TPU VIBRAM® outsole. ESD

- Composite toe cap
- Composite fibre penetration-proof insole

EU	UK		
36	3,5	1	072900336
37	4,5	1	072900337
38	5	1	072900338
39	6	1	072900339
40	6,5	1	072900340
41	7	1	072900341
42	8	1	072900342
43	9	1	072900343
44	10	1	072900344
45	10,5	1	072900345
46	11	1	072900346
47	12	1	072900347
48	13	1	072900348

CE



Speed



EN ISO 20345 2011



S3 SRC ESD

7291NA

full-grain leather ankle shoe, waterproof, with reinforcement polyurethane toe cap cover and PU/TPU VIBRAM® outsole.

ESD

EU	UK		
36	3,5	1	072910336
37	4,5	1	072910337
38	5	1	072910338
39	6	1	072910339
40	6,5	1	072910340
41	7	1	072910341
42	8	1	072910342
43	9	1	072910343
44	10	1	072910344
45	10,5	1	072910345
46	11	1	072910346
47	12	1	072910347
48	13	1	072910348

- Composite toe cap
- Composite fibre penetration-proof insole



Speed



EN ISO 20345 2011



CE

S3 SRC ESD

7300MK

full-grain leather shoe

EU	UK		
36	3,5	1	073000636
37	4,5	1	073000637
38	5	1	073000638
39	6	1	073000639
40	6,5	1	073000640
41	7	1	073000641
42	8	1	073000642
43	9	1	073000643
44	10	1	073000644
45	10,5	1	073000645
46	11	1	073000646
47	12	1	073000647
48	13	1	073000648

- Composite toe cap
- Composite fibre penetration-proof insole



Indy



EN ISO 20345 2011



CE

S3 SRC

7300FT

full-grain leather shoe, "free time" style, waterproof, without toe cap and penetration-proof insole

EU	UK		
36	3,5	1	073000736
37	4,5	1	073000737
38	5	1	073000738
39	6	1	073000739
40	6,5	1	073000740
41	7	1	073000741
42	8	1	073000742
43	9	1	073000743
44	10	1	073000744
45	10,5	1	073000745
46	11	1	073000746
47	12	1	073000747
48	13	1	073000748

- Without toe cap
- Without penetration-proof insole

Formula



EN ISO 20347 2012



CE

O2 FO SRC

7319ESD

suede shoe, perforated, ESD

EU	UK		
36	3,5	1	073190236
37	4,5	1	073190237
38	5	1	073190238
39	6	1	073190239
40	6,5	1	073190240
41	7	1	073190241
42	8	1	073190242
43	9	1	073190243
44	10	1	073190244
45	10,5	1	073190245
46	11	1	073190246
47	12	1	073190247
48	13	1	073190248

- Composite toe cap
- Composite fibre penetration-proof insole

Mistral



EN ISO 20345 2011



CE

S1P SRC ESD

HEAVY DUTY



7293HM

greased full-grain leather shoe, water-repellent, with high-performance VIBRAM® rubber tread, anti-abrasion insert on heel area and reinforcement polyurethane toe cap cover

- Fibreglass toe cap
- Composite fibre penetration proof insole

EU	UK		
39	6		1 072930639
40	6,5		1 072930640
41	7		1 072930641
42	8		1 072930642
43	9		1 072930643
44	10		1 072930644
45	10,5		1 072930645
46	11		1 072930646
47	12		1 072930647
48	13		1 072930648

CE

Heritage



S3 HRO HI SRC



EN ISO 20345 2011



7293HN

Nubuck shoe, waterproof, with SUPPORT SYSTEM for lateral ankle support Durable rubber tread and PU toe cap Wide body

- Steel toe cap
- Composite fibre penetration-proof insole

E	U		
39	6		1 072930839
40	6,5		1 072930840
41	7		1 072930841
42	8		1 072930842
43	9		1 072930843
44	10		1 072930844
45	10,5		1 072930845
46	11		1 072930846
47	12		1 072930847

CE



S3 HRO HI SRC



EN ISO 20345 2011



Beta

7294HM

greased full-grain leather ankle shoe, water-repellent, with high-performance VIBRAM® rubber tread, anti-abrasion insert on heel area and reinforcement polyurethane toe cap cover

- Fibreglass toe cap
- Composite fibre penetration proof insole

EU	UK		
39	6	1	072940639
40	6,5	1	072940640
41	7	1	072940641
42	8	1	072940642
43	9	1	072940643
44	10	1	072940644
45	10,5	1	072940645
46	11	1	072940646
47	12	1	072940647
48	13	1	072940648



Heritage



S3 HRO HI SRC



7294HMC

greased full-grain leather ankle shoe, water-repellent, with high-performance VIBRAM® rubber tread, anti-abrasion insert on heel area and reinforcement polyurethane toe cap cover. With Tepor membrane, waterproof, windproof, highly breathable

- Fibreglass toe cap
- Composite fibre penetration proof insole

EU	UK		
39	6	1	072940739
40	6,5	1	072940740
41	7	1	072940741
42	8	1	072940742
43	9	1	072940743
44	10	1	072940744
45	10,5	1	072940745
46	11	1	072940746
47	12	1	072940747
48	13	1	072940748



Heritage



S3 HRO HI CI WR SRC



7294HN

Nubuck ankle shoe, waterproof, with SUPPORT SYSTEM for lateral ankle support and quick opening system Durable rubber tread and PU toe cap Wide body

- Steel toe cap
- Composite fibre penetration-proof insole

EU	UK		
39	6	1	072940839
40	6,5	1	072940840
41	7	1	072940841
42	8	1	072940842
43	9	1	072940843
44	10	1	072940844
45	10,5	1	072940845
46	11	1	072940846
47	12	1	072940847



S3 HRO HI RS SRC



Beta

ACCESSORIES

7398U

anatomically shaped underfoot covers made of TPR GEL with high cushioning effect, plantar arch support and heel pad



EU	UK		
36 - 40	3,5 - 6,5	1	073980058
41 - 46	7 - 11	1	073980063

7398GEL

anatomically shaped underfoot covers with gel insets



EU	UK		
35	2,5	1	073980835
36	3,5	1	073980836
37	4,5	1	073980837
38	5	1	073980838
39	6	1	073980839
40	6,5	1	073980840
41	7	1	073980841
42	8	1	073980842
43	9	1	073980843
44	10	1	073980844
45	10,5	1	073980845
46	11	1	073980846
47	12	1	073980847
48	13	1	073980848

7398EF

anatomically shaped underfoot covers made of polyurethane foam, with cushioning heel lift



EU	UK		
35	2,5	1	073981135
36	3,5	1	073981136
37	4,5	1	073981137
38	5	1	073981138
39	6	1	073981139
40	6,5	1	073981140
41	7	1	073981141
42	8	1	073981142
43	9	1	073981143
44	10	1	073981144
45	10,5	1	073981145
46	11	1	073981146
47	12	1	073981147
48	13	1	073981148

7399 A/N...

pack of 10 pairs of laces



	cm		
7399A/N 100	100	1	073990010
7399A/N 120	120	1	073990012
7399A/N 140	140	1	073990017

7421

knee-length socks made from elastic compression terry, with nylon and cotton reinforcements on toe and heel areas
Soles made from hard-wearing, antimycotic, breathable bamboo fibre



	EU		
M	39-42	1	074210002
L	43-46	1	074210004

7423

elastic compression ankle-length socks with nylon and cotton reinforcements on toe and heel areas
Soles made from hard-wearing, antimycotic, breathable bamboo fibre



	EU		
M	39-42	1	074230002
L	43-46	1	074230004

7425

ankle-length socks with breathable texture inserts and nylon/cotton reinforcements on toe and heel areas
Soles made from nylon woven with hard-wearing, antimycotic, breathable bamboo fibre



	EU		
M	39-42	1	074250002
L	43-46	1	074250004

7427

maxi sneaker socks with protective, breathable inserts on shinbone and instep areas.
Nylon and cotton reinforcements on toe and heel areas and soles made from hard-wearing, antimycotic, breathable fibre



	EU		
M	39-42	1	074270002
L	43-46	1	074270004

7429

maxi sneaker socks with breathable texture inserts and nylon/cotton reinforcements on toe and heel areas
Soles made from nylon woven with hard-wearing, antimycotic, breathable bamboo fibre



	EU		
M	39-42	1	074290002
L	43-46	1	074290004



WORKWEAR

BetaWORK

Over the years the workwear line has gained confidence and popularity among the most demanding professionals.

The success of the product has translated into the ongoing development and expansion of the range.

The items of clothing produced by Beta Utensili S.p.a. comply with the following standard: **EN ISO 13688:2013**

Personal protective equipment protects the user from limited physical hazards, including small abrasions, sunbeams, wind, cold, non-harmful powders and dirt from nontoxic materials. Such protection is related to the first category of Italian Parliamentary Bill n°. 475 of 04/12/1992.

USE AND STORAGE INSTRUCTIONS

The garment should be worn correctly, so that it can protect the user's body parts. It should be stored in a cool, dry place, in its original packaging, away from heat sources, sunlight, dust and adverse weather.



	I	F	D	E	UK	USA
XS	46	38	42	40	30	32
S	48	40	44	42	32	34
M	50	42	46	44	34	36
L	52	44	48	46	36	38
XL	54	46	50	48	38	40
2XL	56	48	52	50	40	42
3XL	58	50	54	52	42	44
4XL	60	52	56	54	44	46

EN ISO 13688:2013

	XS	S	M	L	XL	2XL	3XL	4XL
A	88-92	92-96	96-104	104-108	108-116	116-124	124-132	132-140
B	79-83	83-87	87-91	91-95	95-100	100-107	107-112	112-120
H	158-164	164-170	170-176	176-182	182-188	188-194	194-200	200-206

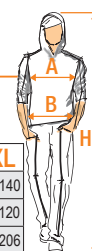

PACKAGING

- WORKWEAR: hanging bag
- FREE TIME WEAR: non-hanging bag

SHRINKAGE

All natural fibres shrink after being washed. The degree of shrinkage may range from 1% to 5%, depending on several parameters, which include the type of fibres and the temperature of water.

7526

work jeans in stretch denim cotton, prewashed 68% denim cotton, 29% polyester, 3% stretch fabric, 10 ounces
Polyester 600D reinforcements in rear pockets and on leg bottoms. Slim fit

CE



XS	1 075260046
S	1 075260048
M	1 075260050
L	1 075260052
XL	1 075260054
XXL	1 075260056
XXXL	1 075260058

7810

"work trekking" trousers, multipocket style, HEAVY 90% nylon, 10% stretch fabric, 265 g/m², anthracite grey
Slim cut, ergonomic fit for ease of movement, bi-stretchable fabric for improved comfort. Reinforced inserts on knees, crotch and leg bottom



S	1 078100101
M	1 078100102
L	1 078100103
XL	1 078100104
XXL	1 078100105

7811

"work trekking" trousers
90% nylon, 10% stretch fabric, 230 g/m², grey
Slim cut, ergonomic fit for ease of movement, bi-stretchable fabric for improved comfort. Reinforced inserts on knees, crotch and leg bottom



S	1 078110001
M	1 078110002
L	1 078110003
XL	1 078110004
XXL	1 078110005

7812

"work trekking" trousers, LIGHT, 95% nylon, 5% stretch fabric, 140 g/m², grey
Slim cut, ergonomic fit for ease of movement, bi-stretchable fabric for improved comfort, reinforced inserts on knees, crotch and leg bottom



S	1 078120001
M	1 078120002
L	1 078120003
XL	1 078120004
XXL	1 078120005

PANTS



7525

prewashed stretch work jeans, 68% denim cotton, 29% polyester, 3% stretch fabric, 10 ounces

CE



XS	1 075250046
S	1 075250048
M	1 075250050
L	1 075250052
XL	1 075250054
XXL	1 075250056
XXXL	1 075250058

7813

"work trekking" Bermuda shorts, LIGHT, 95% nylon, 5% stretch fabric, 140 g/m², grey
Slim cut, ergonomic fit for ease of movement, bi-stretchable fabric for improved comfort



S	1	078130001
M	1	078130002
L	1	078130003
XL	1	078130004
XXL	1	078130005

7816BL

work trousers, multipocket style, T/C canvas, 260 g/m², blue
Knee pad pockets and leg bottoms reinforced in polyester 600D, tearproof crotch and stretch rear insert for easier movements



XS	1	078160100
S	1	078160101
M	1	078160102
L	1	078160103
XL	1	078160104
XXL	1	078160105
XXXL	1	078160106

7816G

work trousers, multipocket style, in T/C canvas 260 g/m², grey
Knee pad pockets and leg bottoms reinforced in polyester 600D, tearproof crotch and elastic rear insert for easier movements



XS	1	078160000
S	1	078160001
M	1	078160002
L	1	078160003
XL	1	078160004
XXL	1	078160005
XXXL	1	078160006

7880SC

stretch work trousers, T/C canvas, 290 g/m², black
Slim fit, tearproof crotch and stretch waistband on sides



XS	1	078800000
S	1	078800001
M	1	078800002
L	1	078800003
XL	1	078800004
XXL	1	078800005
XXXL	1	078800006

SHIRT & T-SHIRT**7546BL**

three-button polo shirt, pique cotton, 220 g/m², blue



XS	2	075460000
S	2	075460001
M	2	075460002
L	2	075460003
XL	2	075460004
XXL	2	075460005
XXXL	2	075460006

7546G

three-button polo shirt, pique cotton, 220 g/m², grey



XS	2	075460100
S	2	075460101
M	2	075460102
L	2	075460103
XL	2	075460104
XXL	2	075460105
XXXL	2	075460106

7546N

three-button polo shirt, pique cotton, 220 g/m², black



XS	2	075460200
S	2	075460201
M	2	075460202
L	2	075460203
XL	2	075460204
XXL	2	075460205
XXXL	2	075460206

7548N

work t-shirt, 100% jersey cotton, 180 g/m², black



XS	5	075480200
S	5	075480201
M	5	075480202
L	5	075480203
XL	5	075480204
XXL	5	075480205
XXXL	5	075480206

7632G

fleece pullover, 280 g/m², with polyester inserts, anthracite grey/black



XS	1	076320000
S	1	076320001
M	1	076320002
L	1	076320003
XL	1	076320004
XXL	1	076320005
XXXL	1	076320006

7548BL

work t-shirt, 100% jersey cotton, 180 g/m², blue



XS	5	075480000
S	5	075480001
M	5	075480002
L	5	075480003
XL	5	075480004
XXL	5	075480005
XXXL	5	075480006

FLEECE



7634G

technical sweatshirt, long-zipped, 325 g/m² 67% polyester, 28% rayon, 5% spandex 3D fabric for improved breathability and freedom of movement



XS	1	076340100
S	1	076340101
M	1	076340102
L	1	076340103
XL	1	076340104
XXL	1	076340105
XXXL	1	076340106

7548G

work t-shirt, 100% jersey cotton, 180 g/m², grey



XS	5	075480100
S	5	075480101
M	5	075480102
L	5	075480103
XL	5	075480104
XXL	5	075480105
XXXL	5	075480106

7622G

fleece jacket, 280 g/m², with polyester inserts, anthracite grey/black



XS	1	076220000
S	1	076220001
M	1	076220002
L	1	076220003
XL	1	076220004
XXL	1	076220005
XXXL	1	076220006

7635N

microfleece sweater, short-zipped, 180 g/m² black



XS	1	076350500
S	1	076350501
M	1	076350502
L	1	076350503
XL	1	076350504
XXL	1	076350505
XXXL	1	076350506

7635G

microfleece sweater, short-zipped, 180 g/m² anthracite grey



XS	1	076350510
S	1	076350511
M	1	076350512
L	1	076350513
XL	1	076350514
XXL	1	076350515
XXXL	1	076350516

7636BL

microfleece sweater, long-zipped, 180 g/m², blue, waist pockets with zip closure



XS	1	076360000
S	1	076360001
M	1	076360002
L	1	076360003
XL	1	076360004
XXL	1	076360005
XXXL	1	076360006

JACKETS

7577N

sleeveless jacket, 100% 50D microfibre polyester, padded, lined, black
Elastic insert at armhole



XS	1	075770000
S	1	075770001
M	1	075770002
L	1	075770003
XL	1	075770004
XXL	1	075770005
XXXL	1	075770006

7579T

sleeveless work jacket, multipocket style, made of waterproof 300D nylon, with stretch inserts for ease of movement, black
Polyester padding, 140 g/m²



S	1	075790001
M	1	075790002
L	1	075790003
XL	1	075790004
XXL	1	075790005
XXXL	1	075790006

7683

softshell jacket, 94% polyester, 6% spandex, 290 g/m² with detachable hood and sleeves, black/orange
Waterproof three layer fabric, with waterproof, windproof, breathable TPU membrane



S	1	076830001
M	1	076830002
L	1	076830003
XL	1	076830004
XXL	1	076830005
XXXL	1	076830006

7684

softshell jacket, 94% polyester, 6% spandex, 290 g/m² black/grey
Waterproof three layer fabric, with waterproof, windproof, breathable TPU membrane



S	1	076840001
M	1	076840002
L	1	076840003
XL	1	076840004
XXL	1	076840005
XXXL	1	076840006

7685

bomber jacket, made of nylon 20D, with down-like polyester padding, 80 g/m², blue
Supplied in a convenient, room-saving bag



S	1	076850001
M	1	076850002
L	1	076850003
XL	1	076850004
XXL	1	076850005

7734

triple use Anorak jacket made of Oxford polyester 300D, waterproof, PU-coated, grey
With foldaway hood and detachable interior jacket, 100% made of polyester, black



S	1	077340001
M	1	077340002
L	1	077340003
XL	1	077340004
XXL	1	077340005
XXXL	1	077340006

7780T

work bomber jacket, multipocket style, made from waterproof nylon 300D, with stretch inserts for ease of movement, black
Polyester padding, 160 g/m², detachable hood



S	1	077800101
M	1	077800102
L	1	077800103
XL	1	077800104
XXL	1	077800105
XXXL	1	077800106

BASIC

7840BL

work trousers, T/C twill, 245 g/m², blue
Stretch waistband on sides

CE



XS	1	078400100
S	1	078400101
M	1	078400102
L	1	078400103
XL	1	078400104
XXL	1	078400105
XXXL	1	078400106
XXXXL	1	078400107

7849BL

work jacket, T/C twill, 245 g/m², blue
Stretch waistband

CE



XS	1	078490100
S	1	078490101
M	1	078490102
L	1	078490103
XL	1	078490104
XXL	1	078490105
XXXL	1	078490106
XXXXL	1	078490107

EASY LIGHT

7860E

work trousers, lightweight,
T/C twill, 180 g/m², with Oxford inserts, grey

CE



XS	1	078600900
S	1	078600901
M	1	078600902
L	1	078600903
XL	1	078600904
XXL	1	078600905
XXXL	1	078600906
XXXXL	1	078600907

7861E

work Bermuda shorts, lightweight,
T/C twill, 180 g/m², grey

CE



XS	1	078610900
S	1	078610901
M	1	078610902
L	1	078610903
XL	1	078610904
XXL	1	078610905
XXXL	1	078610906
XXXXL	1	078610907

7863E

work overalls, lightweight
T/C twill, 180 g/m², with Oxford inserts, grey

CE



XS	1	078630900
S	1	078630901
M	1	078630902
L	1	078630903
XL	1	078630904
XXL	1	078630905
XXXL	1	078630906
XXXXL	1	078630907

7865E

work overalls, lightweight
T/C twill, 180 g/m², with Oxford inserts, grey

CE



XS	1	078650900
S	1	078650901
M	1	078650902
L	1	078650903
XL	1	078650904
XXL	1	078650905
XXXL	1	078650906
XXXXL	1	078650907

7867E

sleeveless work jacket, multipocket style, lightweight, T/C twill, 180 g/m², with Oxford inserts, grey

CE



XS	1	078670900
S	1	078670901
M	1	078670902
L	1	078670903
XL	1	078670904
XXL	1	078670905
XXXL	1	078670906
XXXXL	1	078670907

7869E

work jacket, lightweight, T/C twill, 180 g/m² with Oxford inserts, grey

CE



XS	1	078690900
S	1	078690901
M	1	078690902
L	1	078690903
XL	1	078690904
XXL	1	078690905
XXXL	1	078690906
XXXXL	1	078690907

7870E

work trousers, lightweight, T/C twill 180 g/m², with Oxford inserts, blue

CE



XS	1	078700900
S	1	078700901
M	1	078700902
L	1	078700903
XL	1	078700904
XXL	1	078700905
XXXL	1	078700906
XXXXL	1	078700907

7871E

work Bermuda shorts, lightweight T/C twill 180 g/m², blue

CE



XS	1	078710900
S	1	078710901
M	1	078710902
L	1	078710903
XL	1	078710904
XXL	1	078710905
XXXL	1	078710906
XXXXL	1	078710907

7873E

work overalls, lightweight T/C twill 180 g/m², with Oxford inserts, blue

CE



XS	1	078730900
S	1	078730901
M	1	078730902
L	1	078730903
XL	1	078730904
XXL	1	078730905
XXXL	1	078730906
XXXXL	1	078730907

7875E

work overall, lightweight T/C twill 180 g/m², with Oxford inserts, blue

CE



XS	1	078750900
S	1	078750901
M	1	078750902
L	1	078750903
XL	1	078750904
XXL	1	078750905
XXXL	1	078750906
XXXXL	1	078750907

EASY
LIGHT BLUE

Beta

7877E

sleeveless work jacket, multipocket style, lightweight T/C twill 180 g/m², with Oxford inserts, blue

CE



XS	1	078770900
S	1	078770901
M	1	078770902
L	1	078770903
XL	1	078770904
XXL	1	078770905
XXXL	1	078770906
XXXXL	1	078770907

7879E

work jacket, lightweight, T/C twill 180 g/m², with Oxford inserts, blue

CE



XS	1	078790900
S	1	078790901
M	1	078790902
L	1	078790903
XL	1	078790904
XXL	1	078790905
XXXL	1	078790906
XXXXL	1	078790907

7900E

work trousers, multipocket style, in T/C canvas, 260 g/m², Oxford insets, grey

CE



XS	1	079000900
S	1	079000901
M	1	079000902
L	1	079000903
XL	1	079000904
XXL	1	079000905
XXXL	1	079000906
XXXXL	1	079000907

7901E

work Bermuda shorts in T/C canvas, 260 g/m², grey

CE



XS	1	079010900
S	1	079010901
M	1	079010902
L	1	079010903
XL	1	079010904
XXL	1	079010905
XXXL	1	079010906
XXXXL	1	079010907

7903E

work overalls in T/C canvas, 260 g/m², Oxford insets, grey

CE



XS	1	079030900
S	1	079030901
M	1	079030902
L	1	079030903
XL	1	079030904
XXL	1	079030905
XXXL	1	079030906
XXXXL	1	079030907

7905E

work overalls in T/C canvas, 260 g/m², Oxford insets, grey

CE



XS	1	079050900
S	1	079050901
M	1	079050902
L	1	079050903
XL	1	079050904
XXL	1	079050905
XXXL	1	079050906
XXXXL	1	079050907

EASY

Beta

7904E

work bomber jacket, T/C canvas, 260 g/m², padded, lined, "Oxford" insets, grey

CE

Beta EASY



SIZE	QTY	SKU
XS	1	079040900
S	1	079040901
M	1	079040902
L	1	079040903
XL	1	079040904
XXL	1	079040905
XXXL	1	079040906
XXXXL	1	079040907

7907E

sleeveless work jacket, multipocket style, in T/C canvas, 260 g/m², Oxford insets, grey

CE

Beta EASY



SIZE	QTY	SKU
XS	1	079070900
S	1	079070901
M	1	079070902
L	1	079070903
XL	1	079070904
XXL	1	079070905
XXXL	1	079070906
XXXXL	1	079070907

7909E

work jacket in T/C canvas, 260 g/m², Oxford insets, grey

CE

Beta EASY



SIZE	QTY	SKU
XS	1	079090900
S	1	079090901
M	1	079090902
L	1	079090903
XL	1	079090904
XXL	1	079090905
XXXL	1	079090906
XXXXL	1	079090907

STRETCH

7830ST

stretch work trousers, T/C twill, 250 g/m², grey
Slim fit, tearproof crotch and stretch waistband on sides

CE



SIZE	QTY	SKU
XS	1	078300000
S	1	078300001
M	1	078300002
L	1	078300003
XL	1	078300004
XXL	1	078300005
XXXL	1	078300006

7831ST

stretch work Bermuda shorts, T/C twill, 250 g/m², grey
Slim fit, tearproof crotch and stretch waistband on sides

CE



SIZE	QTY	SKU
XS	1	078310000
S	1	078310001
M	1	078310002
L	1	078310003
XL	1	078310004
XXL	1	078310005
XXXL	1	078310006

7833ST

stretch work overalls, T/C twill, 250 g/m², grey
Slim fit, tearproof crotch and stretch waistband

CE



SIZE	QTY	SKU
XS	1	078330000
S	1	078330001
M	1	078330002
L	1	078330003
XL	1	078330004
XXL	1	078330005
XXXL	1	078330006

7835ST

stretch work overalls, T/C twill, 250 g/m², grey
Slim fit, tearproof crotch and stretch waistband

CE



SIZE	QTY	SKU
XS	1	078350000
S	1	078350001
M	1	078350002
L	1	078350003
XL	1	078350004
XXL	1	078350005
XXXL	1	078350006

TOP LINE

7820

work trousers, twisted T/C canvas, 280 g/m², Cordura® and Reflex 3M Scotchlite™ insets, black/grey

CE



Size	Quantity	Code
XS	1	078200000
S	1	078200001
M	1	078200002
L	1	078200003
XL	1	078200004
XXL	1	078200005
XXXL	1	078200006
XXXXL	1	078200007

7821

work Bermuda shorts, twisted T/C canvas, 280 g/m², black/grey

CE



Size	Quantity	Code
XS	1	078210000
S	1	078210001
M	1	078210002
L	1	078210003
XL	1	078210004
XXL	1	078210005
XXXL	1	078210006
XXXXL	1	078210007

7823

work overalls, twisted T/C canvas, 280 g/m², Cordura® and Reflex 3M Scotchlite™ insets, black/grey

CE



Size	Quantity	Code
XS	1	078230000
S	1	078230001
M	1	078230002
L	1	078230003
XL	1	078230004
XXL	1	078230005
XXXL	1	078230006
XXXXL	1	078230007

7825

work overalls, twisted T/C canvas, 280 g/m², Cordura® and Reflex 3M Scotchlite™ insets, black/grey

CE



Size	Quantity	Code
XS	1	078250000
S	1	078250001
M	1	078250002
L	1	078250003
XL	1	078250004
XXL	1	078250005
XXXL	1	078250006
XXXXL	1	078250007

7829

work jacket, twisted T/C canvas, 280 g/m², Cordura® and Reflex 3M Scotchlite™ insets, black/grey

CE



Size	Quantity	Code
XS	1	078290000
S	1	078290001
M	1	078290002
L	1	078290003
XL	1	078290004
XXL	1	078290005
XXXL	1	078290006
XXXXL	1	078290007

COTTON

7930G

work trousers, 100% stretch cotton, 220 g/m² Slim fit

CE



Size	Quantity	Code
XS	1	079300300
S	1	079300301
M	1	079300302
L	1	079300303
XL	1	079300304
XXL	1	079300305
XXXL	1	079300306

7931G

work Bermuda shorts,
100% stretch cotton, 220 g/m²
Slim fit

CE



SIZE	QTY	SKU
XS	1	079310300
S	1	079310301
M	1	079310302
L	1	079310303
XL	1	079310304
XXL	1	079310305
XXXL	1	079310306

7933G

work overalls,
100% stretch cotton, 220 g/m²
Slim fit

CE



SIZE	QTY	SKU
XS	1	079330300
S	1	079330301
M	1	079330302
L	1	079330303
XL	1	079330304
XXL	1	079330305
XXXL	1	079330306

Beta

7935G

work overalls,
100% stretch cotton, 220 g/m²
Slim fit

CE



SIZE	QTY	SKU
XS	1	079350300
S	1	079350301
M	1	079350302
L	1	079350303
XL	1	079350304
XXL	1	079350305
XXXL	1	079350306

7939G

work jacket,
100% stretch cotton, 220 g/m²
Slim fit

CE



SIZE	QTY	SKU
XS	1	079390300
S	1	079390301
M	1	079390302
L	1	079390303
XL	1	079390304
XXL	1	079390305
XXXL	1	079390306

RAIN

7970

waterproof trousers in PVC Tricot, blue

CE



EN 343

SIZE	QTY	SKU
XS	1	079700000
S	1	079700001
M	1	079700002
L	1	079700003
XL	1	079700004
XXL	1	079700005
XXXL	1	079700006

7971L

waterproof trousers, made of PVC-coated polyester, with thermo-taped seams, blue
With elastic waistband and adjustable press-stud leg bottom

CE



EN 343

SIZE	QTY	SKU
XS	1	079710100
S	1	079710101
M	1	079710102
L	1	079710103
XL	1	079710104
XXL	1	079710105
XXXL	1	079710106

Beta

7978L

waterproof full-length jacket, made of PVC-coated polyester, with fixed hood and thermo-taped seams, blue
Fitted with press studs for use as a 3/4 length jacket

CE



EN 343

XS	1	079780100
S	1	079780101
M	1	079780102
L	1	079780103
XL	1	079780104
XXL	1	079780105
XXXL	1	079780106

7979

waterproof jacket in PVC Tricot, blue

CE



S	1	079790001
M	1	079790002
L	1	079790003
XL	1	079790004
XXL	1	079790005
XXXL	1	079790006

UNDERWEAR

7991N

technical underpants,
100% polyester, 130 g/m², black



S	1	079910001
M	1	079910002
L	1	079910003
XL	1	079910004
XXL	1	079910005

7992N

technical undershirt, long-sleeved,
100% polyester, 130 g/m², black



S	1	079920001
M	1	079920002
L	1	079920003
XL	1	079920004
XXL	1	079920005

ACCESSORIES

7800G

work knee pads pair



7800G	1	078000500
-------	---	-----------

7980N

rainproof cap
100% PU-coated polyester
with water-repellent treatment



L = Ø 58 cm	1	079800058
XL = Ø 60 cm	1	079800060

7980R

cuffed winter cap, 100% acrylic,
3M Thinsulate™ padding, black



7980R	10	079800111
-------	----	-----------

7984G

work belt, 100% TPE, with chrome-plated zinc metal buckle
one size fits all; length: 125 cm, can be shortened; width: 35 mm, black



7984G	1	079840525
-------	---	-----------

7985

neck warmer made of microfleece, with adjuster, black
can also be used as a cap

CE



7985	10	079850111
------	----	-----------

 **Beta**

7104 90

plastic posts with fillable bases



H mm	90	4	071040004
---------	----	---	-----------

7105 6

plastic barrier chain



Ø mm	L m	1	071050006
6	25		

7109A

aluminium warning signs



	H mm		
7109A1	140	1	071090001
7109A2	140	1	071090002
7109A3	140	1	071090003
7109A4	140	1	071090004

7109D

prohibition signs



	H mm		
7109D1	115	1	071090051
7109D2	115	1	071090052
7109D3	115	1	071090053

7195A

dust mask

CE



7195A	10	071950004
-------	----	-----------

7051MP

eye protector
with polycarbonate visor

CE



EN166		
7051MP	5	070510001

7061TC

safety glasses with clear polycarbonate lenses

CE

EASY



7061TC	1	070610001
--------	---	-----------

7076BC

safety glasses with clear polycarbonate lenses

CE

SPORT



EN166F-1F
EN172
UV 5-3.1

7076BC	1	070760009
--------	---	-----------

7076BD

safety glasses with polycarbonate lenses

CE

SPORT



EN166F-1F
EN170
UV 5-2.5

7076BD	1	070760019
--------	---	-----------

7076BP

safety glasses with polarized polycarbonate lenses

CE

SPORT



EN12311

7076BP	1	070760029
--------	---	-----------

7076BU

leak detection glasses with UV lights

CE



EN12312-1

7076BU	1	070760039
--------	---	-----------

7093BC

safety glasses with clear polycarbonate lenses

CE

IMPACT



EN166F-1F
EN170
UV400

7093BC	1	070930009
--------	---	-----------

7093BD

safety glasses with dark polycarbonate lenses

CE

IMPACT



EN166F-1F
EN172
UV5-2.5

7093BD	1	070930019
--------	---	-----------



C62M/W

mannequin



185
cm

65 cm

C62M/W

1 062000360

C63 E/W

clothing and footwear display stand



2250 mm

515 mm

1010 mm

C63E/W

1 063000010

C63 G/C

footwear "gondola" display

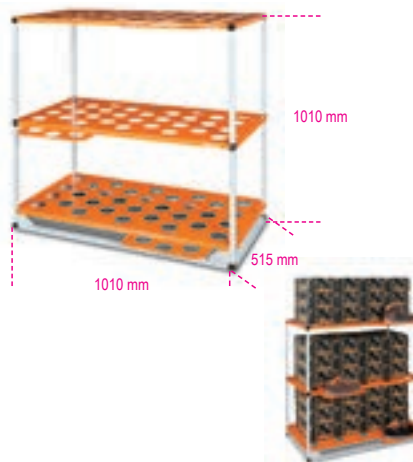

1010 mm

1010 mm

515 mm

C63G/C

1 063000020

6200AP/S10

set of 10 hangers



6200AP/S10

1 062000331

9562TB

mat for trying on shoes, with anti-skid, rubber-coated bottom



600
mm

800 mm

9562TB

1 095620500



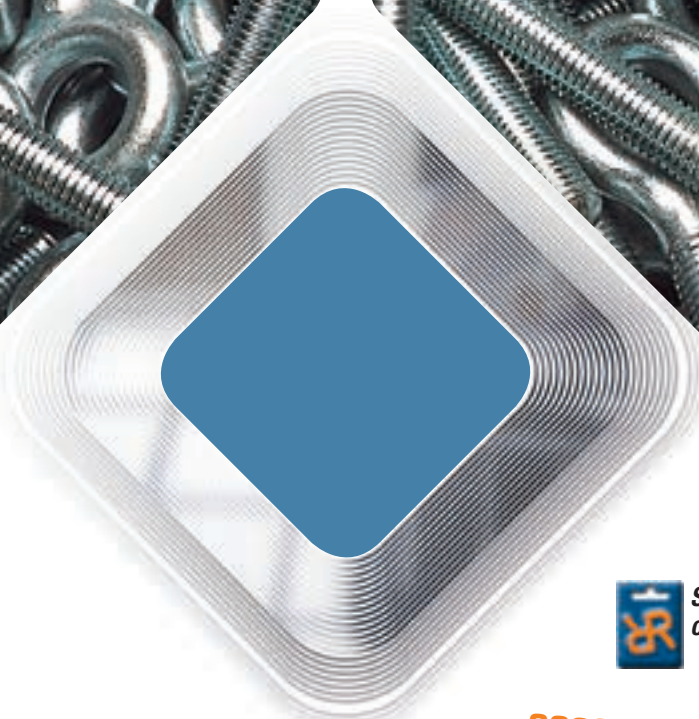

Special free service boxes on page 582

Robur

Since 1930 Robur has been manufacturing accessory lines for cables according to the acknowledged quality standards of Beta Utensili, whose products are complementary to those of Robur. Expertise, organization and technology are the key ingredients of ongoing growth resulting from awareness of market requirements. Since 1984 Robur has been headquartered in a state-of-the-art production facility in Sulmona.

MAXIMUM WORKING LOAD
WLL: working load limit (for lifting accessories)
WFL: workforce limit (for accessories other than lifting accessories)
BF: maximum force achieved by the item during the static traction test
LC: lashing capacity

8029R
 bow shackles with screw collar pins,
 high-tensile alloy steel, GRADE 6,
 hot-dipped galvanized body

CE



EN 13889
 GRADO 6

size	ØA mm	ØD mm	WLL kg	n.° of tools per box	code number
8029R	6	8	500	20	080290106
8029R	8	10	750	15	080290108
8029R	10	11	1000	15	080290110
8029R	11	13	1500	10	080290111
8029R	13	16	2000	8	080290112
8029R	16	19	3250	5	080290116
8029R	19	22	4750	2	080290120
8029R	22	25	6500	2	080290122
8029R	26	28	8500	1	080290124
8029R	29	32	9500	1	080290128
8029R	32	35	12000	1	080290132
8029R	35	38	13500	1	080290135
8029R	38	42	17000	1	080290138
8029R	45	50	25000	1	080290145
8029R	50	50	35000	1	080290150
8029R	57	57	42500	1	080290157
8029R	65	65	55000	1	080290165

new item 2020

■ 4 DIFFERENT TYPES OF CERTIFICATES

■ 161 UPDATED PRODUCT SPECIFICATIONS

Item	Test Report 2.2 (UNI EN 10204)	Test Certificate 3.1(UNI EN 10204)	Manufacturer's Certificate	CE Declaration of Conformity
8001Z	✓	✓		✓
8001TZ	✓	✓		✓
8002ZD	✓			
8003ZD	✓			
8004ND	✓			
8005Z	✓			✓
8005TZ	✓			✓
8006Z	✓			✓
8007Z	✓			✓
8008N	✓			✓
8008TZN	✓			✓
8009FD	✓			
8009Z	✓			✓
8009TZ	✓			✓
8010Z	✓			✓
8010TZ	✓			
8016	✓			✓
8016DA	✓			✓
8016FR	✓			
8016U2	✓		✓	✓
8018E	✓			
8018T	✓			
8020	✓			
8021	✓			
8025	✓	✓		✓
8026A	✓	✓		✓
8026R	✓	✓		✓
8028	✓	✓		✓
8029R	✓	✓		✓
8031R	✓	✓		✓
8032	✓	✓		✓
8040EN	✓	✓		✓
8040EZ	✓	✓		✓
8042EN	✓	✓		✓
8042EZ	✓	✓		✓
8044	✓	✓		✓
8048	✓			
8049	✓	✓		✓
8051S	✓	✓		✓
8052	✓	✓		✓
8055S	✓	✓		✓
8057R	✓	✓		✓
8058R	✓	✓		✓
8060R	✓	✓		✓
8061F	✓	✓		✓
8062	✓	✓		✓
8063	✓	✓		✓
8064S	✓	✓		✓
8065SC	✓	✓		✓
8074	✓			
8074A	✓			
8074G	✓			
8080	✓			
8085	✓	✓		✓
8086	✓	✓		✓
8090	✓	✓		✓
8090F	✓	✓		✓

Item	Test Report 2.2 (UNI EN 10204)	Test Certificate 3.1(UNI EN 10204)	Manufacturer's Certificate	CE Declaration of Conformity
8090R	✓	✓		✓
8091			✓	✓
8091SL			✓	✓
8092			✓	✓
8092SL			✓	✓
8094			✓	✓
8094SL			✓	✓
8096			✓	✓
8096SL			✓	✓
8097			✓	✓
8097SL			✓	✓
8098			✓	✓
8098SL			✓	✓
8100	✓	✓		✓
8105	✓			
8109	✓			
8110	✓			
8114	✓			
8116	✓			
8120	✓			
8120B	✓			
8130A	✓			
8139DL	✓			
8150	✓		✓	✓
8153	✓		✓	✓
8156	✓		✓	✓
8157	✓		✓	✓
8158	✓		✓	✓
8159	✓		✓	✓
8160	✓		✓	✓
8161	✓		✓	✓
8166	✓			
8170	✓		✓	✓
8173	✓		✓	✓
8176	✓		✓	✓
8177	✓		✓	✓
8178	✓		✓	✓
8179M-B-A	✓		✓	✓
8180	✓			
8181	✓			
8181S	✓			
8182	✓			
8182A	✓			
8182E	✓			
8182H	✓			
8182M	✓			
8182S	✓			
8182T	✓			
8182T-TS	✓			
8182TS	✓			
8185	✓			
8186	✓			
8187	✓			
8188C	✓			
8188CG/25	✓			
8188CU	✓			
8188F	✓			

Item	Test Report 2.2 (UNI EN 10204)	Test Certificate 3.1(UNI EN 10204)	Manufacturer's Certificate	CE Declaration of Conformity
8188VF/35	✓			
8188FG2	✓			
8302Z	✓			
8303Z	✓			
8317DZ	✓			
8317SZ	✓			
8381SL	✓			
8381SP	✓			
8383C	✓			
8383P	✓			
8515V	✓			
8515Z	✓			
8531	✓			
8532	✓			
8535	✓			
8201T	✓			
8205	✓			
8206	✓			
8207	✓			
8209	✓			
8210	✓			
8216	✓			✓
8220	✓			
8225	✓			
8227	✓			
8228	✓			
8240	✓			
8240F	✓	✓		✓
8242	✓			
8242F	✓	✓		✓
8248	✓			
8249	✓			
8249G	✓			
8250	✓			
8264	✓			
8267	✓			
8272	✓			
8273	✓			
8274	✓			
8274A	✓			
8274G	✓			
8276	✓			
8276G	✓			
8278	✓			
8280	✓			
8282	✓			
8282S	✓			
8284	✓			
8285	✓			
8286	✓			
8287	✓			
8290	✓			
8293	✓			
8297C	✓			
8297F	✓			
8381SX	✓			

8001Z

turnbuckle bodies,
galvanized



TECHNICAL DATA

- safety factor: 4
- traceability code
- LABORATORY TESTS**
- chemical analysis
- tensile test

AVAILABLE CERTIFICATES

- Technical product specifications
- Test report UNI EN10204 type 2.2
- CE Declaration of Conformity

Ø mm	≈ "	L mm	WFL kg		
M5	3/16	80	115	100	080010105
M6	1/4	80	160	100	080010106
M8	5/16	105	300	25	080010108
M10	3/8	125	470	20	080010110
M11	7/16	135	580	15	080010111
M12	1/2	140	690	20	080010112
M14	9/16	170	940	15	080010114
M16	5/8	190	1290	15	080010116
M18	11/16	205	1660	10	080010118
M20	3/4	220	2130	10	080010120
M22	7/8	240	2630	8	080010122
M24	1"	260	3060	5	080010124
M27	1 1/8	270	4000	1	080010127
M30	1 3/16	280	4860	1	080010130
M33	1 1/4	290	6040	1	080010133
M36	1 3/8	300	6500	1	080010198
M39	1 1/2	300	7900	1	080010199

Whitworth thread subject to availability
New batches with metric thread

8001TZ

pipe turnbuckle bodies,
galvanized



DIN 1478

TECHNICAL DATA

- safety factor: 4
- traceability code
- LABORATORY TESTS**
- chemical analysis
- tensile test

AVAILABLE CERTIFICATES

- Technical product specifications
- Test report UNI EN10204 type 2.2
- CE Declaration of Conformity

Ø mm	≈ "	L mm	WFL kg		
M12	1/2	125	690	10	080010512
M16	5/8	170	1290	5	080010516
M20	3/4	200	2130	5	080010520
M24	1	255	3060	3	080010524
* M27	1.1/8	255	4000	1	080010527
M30	1.3/16	255	4860	1	080010530
M36	1.3/8	295	6500	1	080010536
M42	1.5/8	330	9700	1	080010542

* Sizes not contemplated by the standard

8002ZD

turnbuckle eyes
right thread, galvanized



TECHNICAL DATA

- safety factor: 4
- LABORATORY TESTS**
- chemical analysis
- tensile test

AVAILABLE CERTIFICATES

- Technical product specifications
- Test report UNI EN10204 type 2.2

Ø mm	≈ "	E mm	WFL kg		
M5	3/16	37	115	200	080020105
M6	1/4	40	160	150	080020106
M8	5/16	52	300	100	080020108
M10	3/8	60	470	100	080020110
M11	7/16	65	580	1	080020111
M12	1/2	72	690	50	080020112
M14	9/16	85	940	1	080020114
M16	5/8	95	1290	1	080020116
M18	11/16	103	1660	1	080020118
M20	3/4	110	2130	1	080020120
M22	7/8	120	2630	1	080020122
M24	1"	130	3060	1	080020124
M27	1 1/8	135	4000	1	080020127
M30	1 3/16	140	4860	1	080020130
M33	1 1/4	148	6040	1	080020133
M36	1 3/8	150	6500	1	080020198
M39	1 1/2	150	7900	1	080020199

Whitworth thread subject to availability
New batches with metric thread

left-handed thread

Ø mm	≈ "	E mm	WFL kg		
M5	3/16	37	115	1	080020305
M6	1/4	40	160	1	080020306
M8	5/16	52	300	1	080020308
M10	3/8	60	470	1	080020310
M11	7/16	65	580	1	080020311
M12	1/2	72	690	1	080020312
M14	9/16	85	940	1	080020314
M16	5/8	95	1290	1	080020316
M18	11/16	103	1660	1	080020318
M20	3/4	110	2130	1	080020320
M22	7/8	120	2630	1	080020322
M24	1"	130	3060	1	080020324
M27	1 1/8	135	4000	1	080020327
M30	1 3/16	140	4860	1	080020330
M33	1 1/4	148	6040	1	080020333
M36	1 3/8	150	6500	1	080020398
M39	1 1/2	150	7900	1	080020399

left-handed thread

Ø mm	≈ "	E mm	WFL kg		
M5	3/16	40	115	1	080040105
M6	1/4	44	160	1	080040106
M8	5/16	53	300	1	080040108
M10	3/8	63	470	1	080040110
M12	1/2	70	690	1	080040112
M14	9/16	85	940	1	080040114
M16	5/8	95	1290	1	080040116
M18	11/16	103	1660	1	080040118
M20	3/4	110	2130	1	080040120
M22	7/8	120	2630	1	080040122
M24	1"	130	3060	1	080040124
M27	1 1/8	135	4000	1	080040127
M30	1 3/16	140	4860	1	080040130
M33	1 1/4	150	6040	1	080040133
M36	1 3/8	150	6500	1	080040198
M39	1 1/2	150	7900	1	080040199



8004ND

turnbuckle stubs
right-handed thread, self-coloured

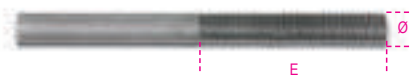

TECHNICAL DATA

- safety factor: 4
- LABORATORY TESTS**
- chemical analysis
- tensile test

AVAILABLE CERTIFICATES

- Technical product specifications
- Test report UNI EN10204 type 2.2

Ø mm	≈ "	E mm	WFL kg		
M5	3/16	40	115	1	080040005
M6	1/4	44	160	1	080040006
M8	5/16	53	300	1	080040008
M10	3/8	63	470	1	080040010
M12	1/2	70	690	1	080040012
M14	9/16	85	940	1	080040014
M16	5/8	95	1290	1	080040016
M18	11/16	103	1660	1	080040018
M20	3/4	110	2130	1	080040020
M22	7/8	120	2630	1	080040022
M24	1"	130	3060	1	080040024
M27	1 1/8	135	4000	1	080040027
M30	1 3/16	140	4860	1	080040030
M33	1 1/4	150	6040	1	080040033
M36	1 3/8	150	6500	1	080040098
M39	1 1/2	150	7900	1	080040099

Whitworth thread subject to availability
New batches with metric thread

8003ZD

turnbuckle hooks
right thread, galvanized



TECHNICAL DATA

• safety factor: 4

LABORATORY TESTS

• chemical analysis

• tensile test

AVAILABLE CERTIFICATES

• Technical product specifications

• Test report UNI EN10204 type 2.2

Ø mm	≈ "	E mm	WFL kg		
M5	3/16	40	25	150	080030105
M6	1/4	40	45	120	080030106
M8	5/16	52	95	100	080030108
M10	3/8	60	140	70	080030110
M11	7/16	65	165	1	080030111
M12	1/2	70	300	30	080030112
M14	9/16	85	420	1	080030114
M16	5/8	95	570	1	080030116
M18	11/16	103	700	1	080030118
M20	3/4	110	900	1	080030120
M22	7/8	120	1100	1	080030122
M24	1"	130	1300	1	080030124
M27	1 1/8	135	2300	1	080030127

left-handed thread

Ø mm	≈ "	WFL kg	E mm		
M5	3/16	40	25	1	080030305
M6	1/4	40	45	1	080030306
M8	5/16	52	95	1	080030308
M10	3/8	60	140	1	080030310
M11	7/16	65	165	1	080030311
M12	1/2	70	300	1	080030312
M14	9/16	85	420	1	080030314
M16	5/8	95	570	1	080030316
M18	11/16	103	700	1	080030318
M20	3/4	110	900	1	080030320
M22	7/8	120	1100	1	080030322
M24	1"	130	1300	1	080030324
M27	1 1/8	135	2300	1	080030327

8009FD

turnbuckle jaws
right-handed thread, galvanized

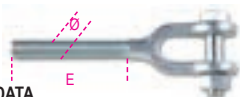

TECHNICAL DATA

• safety factor: 4

LABORATORY TESTS

• chemical analysis

• tensile test

AVAILABLE CERTIFICATES

• Technical product specifications

• Test report UNI EN10204 type 2.2

Ø mm	≈ "	E mm	WFL kg		
M8	5/16	53	300	1	080090208
M10	3/8	63	470	1	080090210
M12	1/2	70	690	1	080090212
M14	9/16	85	940	1	080090214
M16	5/8	95	1290	1	080090216
M18	11/16	103	1660	1	080090218
M20	3/4	110	2130	1	080090220
M22	7/8	120	2630	1	080090222
M24	1"	130	3060	1	080090224
M27	1 1/8	135	4000	1	080090227
M30	1 3/16	140	4860	1	080090230

left-handed thread

Ø mm	≈ "	E mm	WFL kg		
M8	5/16	53	300	1	080090408
M10	3/8	63	470	1	080090410
M12	1/2	70	690	1	080090412
M14	9/16	85	940	1	080090414
M16	5/8	95	1290	1	080090416
M18	11/16	103	1660	1	080090418
M20	3/4	110	2130	1	080090420
M22	7/8	120	2630	1	080090422
M24	1"	130	3060	1	080090424
M27	1 1/8	135	4000	1	080090427
M30	1 3/16	140	4860	1	080090430

8005Z

eye and eye turnbuckles,
galvanized

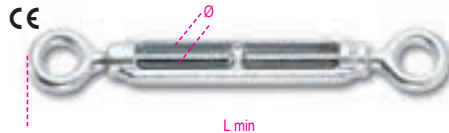

TECHNICAL DATA

• safety factor: 4

LABORATORY TESTS

• chemical analysis

• tensile test

AVAILABLE CERTIFICATES

• Technical product specifications

• Test report UNI EN10204 type 2.2

• CE Declaration of Conformity

Ø mm	≈ "	L min mm	WFL kg		
M5	3/16	118	115	400	080050105
M6	1/4	130	160	300	080050106
M8	5/16	158	300	200	080050108
M10	3/8	192	470	100	080050110
M11	7/16	206	580	80	080050111
M12	1/2	226	690	60	080050112
M14	9/16	256	940	15	080050114
M16	5/8	290	1290	10	080050116
M18	11/16	358	1660	1	080050118
M20	3/4	358	2130	1	080050120
M22	7/8	400	2630	1	080050122
M24	1"	436	3060	1	080050124
M27	1 1/8	474	4000	1	080050125
M30	1 3/16	498	4860	1	080050130
M33	1 1/4	516	6040	1	080050126
M36	1 3/8	532	6500	1	080050136
M39	1 1/2	544	7900	1	080050139

Whitworth thread subject to availability

New batches with metric thread

special packaging

Ø mm	≈ "	WFL kg		
M5	3/16	30	1	080050705
M6	1/4	30	1	080050706
M8	5/16	20	1	080050708
M10	3/8	15	1	080050710
M11	7/16	15	1	080050711
M12	1/2	15	1	080050712



Robur

8005TZ

hot-forged eye and eye turnbuckles
pipe bodies, galvanized



TECHNICAL DATA

• safety factor: 4

LABORATORY TESTS

• chemical analysis

• tensile test

AVAILABLE CERTIFICATES

• Technical product specifications

• Test report UNI EN10204 type 2.2

• CE Declaration of Conformity

Ø mm	≈ "	WFL kg		
M12	1/2	690	15	080050512
M16	5/8	1290	1	080050516
M20	3/4	2130	1	080050520
M24	1"	3060	1	080050524
M27	1.1/8	4000	1	080050527
M30	1.3/16	4860	1	080050530
M36	1.3/8	6500	1	080050536

8006Z

hook and eye turnbuckles,
galvanized



TECHNICAL DATA

• safety factor: 4

LABORATORY TESTS

• chemical analysis

• tensile test

AVAILABLE CERTIFICATES

• Technical product specifications

• Test report UNI EN10204 type 2.2

• CE Declaration of Conformity

Ø mm	≈ "	L min mm	WFL kg		
M5	3/16	121	25	400	080060105
M6	1/4	132	45	250	080060106
M8	5/16	170	95	180	080060108
M10	3/8	204	140	100	080060110
M11	7/16	221	165	15	080060111
M12	1/2	244	300	15	080060112
M14	9/16	284	420	10	080060114
M16	5/8	322	570	1	080060116
M18	11/16	373	700	1	080060118
M20	3/4	391	900	1	080060120
M22	7/8	433	1100	1	080060122
M24	1"	470	1300	1	080060124
M27	1 1/8	503	2300	1	080060127

special packaging

Ø mm	≈ "	WFL kg		
M5	3/16	30	1	080060705
M6	1/4	30	1	080060706
M8	5/16	20	1	080060708
M10	3/8	15	1	080060710

8007Z

hook and hook turnbuckles,
galvanized

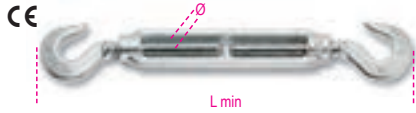

TECHNICAL DATA

- safety factor: 4
- LABORATORY TESTS**
- chemical analysis
- tensile test
- AVAILABLE CERTIFICATES**
- Technical product specifications
- Test report UNI EN10204 type 2.2
- CE Declaration of Conformity

Ø mm	≈ "	L min mm	WFL kg		
M5	3/16	124	25	30	080070105
M6	1/4	134	45	30	080070106
M8	5/16	181	95	20	080070108
M10	3/8	211	140	15	080070110
M11	7/16	231	165	15	080070111
M12	1/2	262	300	15	080070112
M14	9/16	312	420	1	080070114
M16	5/8	354	570	1	080070116
M18	11/16	388	700	1	080070118
M20	3/4	424	900	1	080070120
M22	7/8	466	1100	1	080070122
M24	1"	504	1300	1	080070124
M27	1 1/8	532	2300	1	080070127

8008N

stub and stub turnbuckles
self-coloured

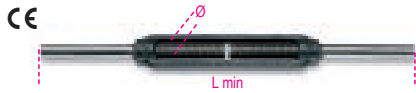

TECHNICAL DATA

- safety coefficient: 4
- LABORATORY TESTS**
- chemical analysis
- tensile test
- AVAILABLE CERTIFICATES**
- Technical product specifications
- Test report UNI EN10204 type 2.2
- CE Declaration of Conformity

Ø mm	≈ "	L min mm	WFL kg		
M5	3/16	160	115	30	080080205
M6	1/4	180	160	30	080080206
M8	5/16	210	300	20	080080208
M10	3/8	250	470	15	080080210
M12	1/2	280	690	15	080080212
M14	9/16	340	940	5	080080214
M16	5/8	380	1290	5	080080216
M18	11/16	410	1660	3	080080218
M20	3/4	440	2130	3	080080220
M22	7/8	480	2630	2	080080222
M24	1"	520	3060	2	080080224
M27	1 1/8	560	4000	1	080080227
M30	1 3/16	560	4860	1	080080230
M33	1 1/4	600	6040	1	080080233
M36*	1 3/8	600	6500	1	080080236
M39*	1 1/2	600	7900	1	080080239

Whitworth thread subject to availability
New batches with metric thread

8008TZN

stub and stub turnbuckles,
pipe bodies DIN 1478,
self-coloured terminals, galvanised bodies



TECHNICAL DATA

- safety factor: 4
- LABORATORY TESTS**
- chemical analysis
- tensile test
- AVAILABLE CERTIFICATES**
- Product specifications
- Test report type 2.2 UNI EN10204
- CE Declaration of Conformity

Ø mm	≈ "	WFL kg		
M12	1/2	690	10	080080512
M16	5/8	1290	1	080080516
M20	3/4	2130	1	080080520
M24	1	3060	1	080080524
M27	1.1/8	4000	1	080080527
M30	1.3/16	4860	1	080080530
M36	1.3/8	6500	1	080080536

8009Z

jaw and jaw turnbuckles,
galvanized

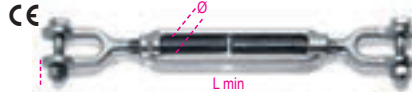

TECHNICAL DATA

- safety coefficient: 4
- LABORATORY TESTS**
- chemical analysis
- tensile test
- AVAILABLE CERTIFICATES**
- Technical product specifications
- Test report UNI EN10204 type 2.2
- CE Declaration of Conformity

Ø mm	≈ "	L min mm	WFL kg		
M8	5/16	192	300	15	080090008
M10	3/8	234	470	15	080090010
M12	1/2	274	690	15	080090012
M14	9/16	342	940	1	080090014
M16	5/8	372	1290	1	080090016
M18	11/16	406	1660	1	080090018
M20	3/4	406	2130	1	080090020
M22	7/8	466	2630	1	080090022
M24	1"	486	3060	1	080090024
M27	1 1/8	510	4000	1	080090027
M30	1 3/16	566	4860	1	080090030

8009TZ

jaw and jaw turnbuckles,
pipe bodies, DIN 1478
galvanized



TECHNICAL DATA

- safety coefficient: 4
- LABORATORY TESTS**
- chemical analysis
- tensile test
- AVAILABLE CERTIFICATES**
- Technical Product Specifications
- Test Report UNI EN10204 type 2.2
- CE Declaration of Conformity

Ø mm	≈ "	WFL kg		
M12	1/2	690	10	080090512
M16	5/8	1290	1	080090516
M20	3/4	2130	1	080090520
M24	1	3060	1	080090524
M27	1.1/8	4000	1	080090527
M30	1.3/16	4860	1	080090530

8010Z

eye and jaw turnbuckles,
galvanized

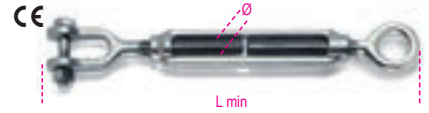

TECHNICAL DATA

- safety coefficient: 4
- LABORATORY TESTS**
- chemical analysis
- tensile test
- AVAILABLE CERTIFICATES**
- Technical product specifications
- Test report UNI EN10204 type 2.2
- CE Declaration of Conformity

Ø mm	≈ "	L min mm	WFL kg		
M8	5/16	175	300	20	080100008
M10	3/8	215	470	15	080100010
M12	1/2	250	690	10	080100012
M14	9/16	299	940	10	080100014
M16	5/8	331	1290	1	080100016
M18	11/16	382	1660	1	080100018
M20	3/4	382	2130	1	080100020
M22	7/8	433	2630	1	080100022
M24	1"	461	3060	1	080100024
M27	1 1/8	492	4000	1	080100027
M30	1 3/16	529	4860	1	080100030

8010TZ

eye and jaw turnbuckles,
pipe bodies DIN 1478,
galvanized



TECHNICAL DATA

- safety factor: 4
- LABORATORY TESTS** • chemical analysis
- tensile test
- AVAILABLE CERTIFICATES**
- Production specifications
- Test report type 2.2 UNI EN10204
- CE Declaration of Conformity

Ø mm	≈ "	WFL kg		
M12	1/2	690	10	080100612
M16	5/8	1290	1	080100616
M20	3/4	2130	1	080100620
M24	1	3060	1	080100624
M27	1.1/8	4000	1	080100627
M30	1.3/16	4860	1	080100630

Robur

8105

eye and eye turnbuckles
high tensile steel, hot dip galvanized

CE



TECHNICAL DATA

- safety factor: 5
- heat treatment, body: normalizing
- heat treatment, eyes: hardening and tempering

LABORATORY TESTS

- chemical analysis
 - tensile test
 - proof load test 2 x WFL
- AVAILABLE CERTIFICATES
- Technical product specifications
 - Test report UNI EN10204 type 2.2

ØxE	≈	WFL		
"	mm	kg		
3/8x6	M10x150	540	5	081050010
1/2x6	M12x150	1000	5	081050011
1/2x9	M12x230	1000	5	081050012
5/8x9	M16x230	1590	2	081050016
3/4x6	M20x150	2360	2	081050017
3/4x12	M20x300	2360	2	081050018
3/4x9	M20x230	2360	2	081050020
3/4x18	M20x460	2360	2	081050021
7/8x12	M22x300	3270	1	081050022
1x6	M24x150	4540	1	081050024
1x12	M24x300	4540	1	081050025
1.1/4x12	M33x300	6900	1	081050031
1.1/4x18	M33x460	6900	1	081050032
1.1/2x12	M39x300	9710	1	081050034
1.1/2x18	M39x460	9710	1	081050035
1.3/4x18	M45x460	12700	1	081050036

Other sizes available upon request

8109

jaw and jaw turnbuckles
high tensile steel, hot dip galvanized

CE

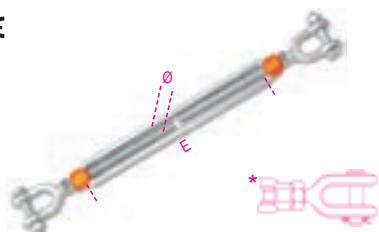

TECHNICAL DATA

- safety factor: 5
- heat treatment, body: normalizing
- heat treatment, jaws: hardening and tempering

LABORATORY TESTS

- chemical analysis
 - tensile test
- AVAILABLE CERTIFICATES
- Technical product specifications
 - Test report UNI EN10204 type 2.2

ØxE	≈	WFL		
"	mm	kg		
3/8x6	M10x150	540	5	081090010
1/2x6	M12x150	1000	5	081090011
1/2x9	M12x230	1000	5	081090012
1/2x12	M12x300	1000	5	081090013
5/8x6	M16x150	1590	2	081090015
5/8x9	M16x230	1590	2	081090016
3/4x6	M20x150	2360	2	081090018
3/4x12	M20x300	2360	2	081090019
3/4x9	M20x230	2360	2	081090020
3/4x18	M20x460	2360	2	081090021
7/8x12	M22x300	3270	1	081090022
7/8x18	M22x460	3270	1	081090023
1x6	M24x150	4540	1	081090024
1x12	M24x300	4540	1	081090025
1x18	M24x460	4540	1	081090026
* 1.1/4x12	M33x300	6900	1	081090031

ØxE	≈	WFL		
"	mm	kg		
* 1.1/4x18	M33x460	6900	1	081090032
* 1.1/4x24	M33x610	6900	1	081090033
* 1.1/2x12	M39x300	9710	1	081090034
* 1.1/2x18	M39x460	9710	1	081090038
* 1.1/2x24	M39x610	9710	1	081090039
* 1.3/4x18	M45x460	12700	1	081090036

* Round pin Jaw

Other sizes available upon request

8110

eye and jaw turnbuckles, high-tensile steel,
hot dip galvanized

CE

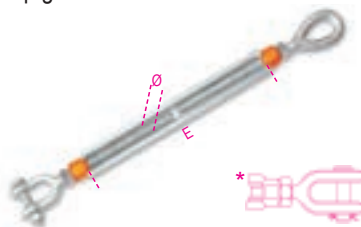

TECHNICAL DATA

- safety factor: 5
- turnbuckle body heat treatment: normalizing
- turnbuckle eye treatment: hardening and tempering

LABORATORY TESTS

- chemical analysis
 - tensile test
- AVAILABLE CERTIFICATES
- Technical product specifications
 - Test report UNI EN10204 type 2.2
 - Inspection certificate UNI EN10204 type 3.1
 - CE Declaration of Conformity

ØxE	≈	WFL		
"	mm	kg		
1/2x9	M12x230	1000	5	081100010
5/8x12	M16x300	1590	2	081100016
3/4x6	M20x150	2360	2	081100019
3/4x9	M20x230	2360	2	081100020
3/4x12	M20x300	2360	2	081100021
1x6	M24x150	4540	1	081100027
1x12	M24x300	4540	1	081100029
* 1.1/4x12	M33x300	6900	1	081100034
* 1.1/2x12	M39x300	9710	1	081100038
* 1.1/2x18	M39x460	9710	1	081100039
* 1.3/4x18	M45x460	12700	1	081100044

* Jaw with through pin and split pin

Other sizes available on request

8016U2

wire rope clips
malleable cast iron body
galvanized

CE

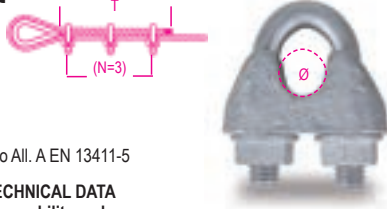

tipo All. A EN 13411-5

TECHNICAL DATA

- traceability code
- LABORATORY TESTS
- chemical analysis
 - torque test
- AVAILABLE CERTIFICATES
- Technical product specifications
 - Test report UNI EN10204 type 2.2
 - Manufacturer's Certificate UNI EN13411-5
 - CE Certificate of Conformity

Ø	Ø	N x T	Nm		
mm	"				
5	3/16	3x156	2,0	300	080160855
6,5	1/4	3x192	3,5	150	080160856
8	5/16	4x320	6	70	080160858
10	3/8	4x320	9	60	080160860
12	1/2	4x384	20	25	080160862
14	9/16	4x448	33	15	080160864
16	5/8	4x512	49	10	080160866

Ø	Ø	N x T	Nm		
mm	"				
19	3/4	4x512	68	10	080160869
22	7/8	5x680	107	10	080160872
26	1	5x760	147	5	080160876
30	1.1/8	6x984	212	5	080160880
34	1.1/4	6x1080	296	5	080160884
40	1.1/2	6x1176	363	5	080160890

8016

wire rope clips,
hot forged steel body,
galvanized

CE

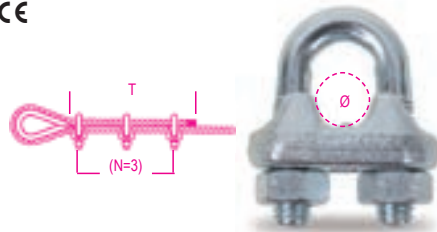

TECHNICAL DATA

- chemical analysis
 - torque test
- AVAILABLE CERTIFICATES
- Technical product specifications
 - Test report UNI EN10204 type 2.2
 - CE Certificate of Conformity

Ø	Ø	N x T	Nm		
mm	"				
3	1/8	3x80	1,53	500	080160003
5	3/16	3x110	3,02	300	080160005
6	1/4	3x120	5,19	200	080160006
8	5/16	5x210	5,19	150	080160008
10	3/8	5x240	12,54	70	080160010
11	7/16	5x240	12,54	70	080160011
12-13	1/2	5x300	24,76	40	080160013
14	9/16	5x295	24,76	35	080160014
16	5/8	5x335	24,76	30	080160016
18	11/16	5x380	42,42	30	080160018
20	3/4	5x540	42,42	30	080160020
22	7/8	7x595	42,42	25	080160022
24-26	1"	7x700	67,56	15	080160026
28	1"1/16	8x840	67,56	5	080160028
30-32	1"1/8	8x990	67,56	5	080160030
34-36	1"1/4	8x1155	105,80	4	080160034
38-40	1"1/2	8x1320	105,80	2	080160040
45-50	2"	8x1500	206	1	080160050

special packaging

Ø					
mm	"				
3	1/8	100		1	080160703
5	3/16	50		1	080160705
6	1/4	50		1	080160706
8	5/16	30		1	080160708
10	3/8	30		1	080160710
11	7/16	25		1	080160711
12-13	1/2	15		1	080160713



8016DA

wire rope clips with high nuts,
hot forged steel body,
galvanized

CE

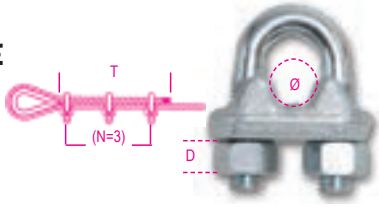

LABORATORY TESTS

- chemical analysis
- torque test

AVAILABLE CERTIFICATES

- Technical product specifications
- Test report UNI EN10204 type 2.2
- CE Certificate of Conformity

Ø mm	N x T mm	Nm	D mm		
5	3x110	3,02	5	300	080160093
6	3x120	5,19	6	200	080160092
8	5x210	5,19	6	150	080160098
10	5x240	12,54	8	70	080160096

8016FR

wire rope clips,
cold pressed steel body,
galvanized

CE

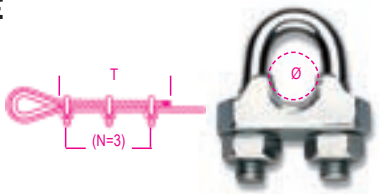

LABORATORY TESTS

- chemical analysis

AVAILABLE CERTIFICATES

- Technical product specifications
- Test report UNI EN10204 type 2.2
- CE Certificate of Conformity

Ø mm	Ø mm	N x T mm	Nm		
3	1/8	3x80	1,25	500	080160253
5	3/16	3x110	2,46	300	080160255
6	1/4	3x120	4,24	200	080160256
8	5/16	5x210	4,24	150	080160258

8018E

wire rope clips, ENEL type,
hot forged steel body, hot-dip galvanized
U-bolts and nuts with chemical galv. protection



LABORATORY TESTS

- chemical analysis

AVAILABLE CERTIFICATES

- Technical product specifications
- Test report UNI EN10204 type 2.2

Ø mm	A mm	L mm	Nm		
4÷6	M6	34	4,24	100	080180001

8018T

wire rope clips, TELECOM type
malleable cast iron body
galvanized



RUM-MU-21:1980

LABORATORY TESTS

- chemical analysis

AVAILABLE CERTIFICATES

- Technical product specifications
- Test report UNI EN10204 type 2.2

Ø mm	A mm	L mm	Nm		
8÷10	M8	42	10,20	200	080180003

8317DZ

duplex wire rope clips
galvanized

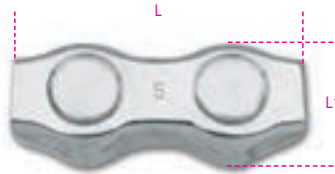

AVAILABLE CERTIFICATES

- Test report UNI EN10204 type 2.2

Ø mm	L mm	L1 mm		
2	30	14	50	083170002
3	35	15	50	083170003
4	40	18	50	083170004
5	50	21	25	083170005
6	60	25	20	083170006
8	76	33	10	083170008
10	95	37	10	083170010

8317SZ

simplex wire rope clips
galvanized

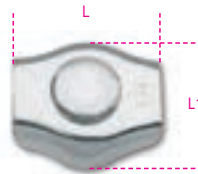

AVAILABLE CERTIFICATES

- Test report UNI EN10204 type 2.2

Ø mm	L mm	L1 mm		
2	15	14	100	083170102
3	18	16	100	083170103
4	20	19	100	083170104
5	24	23	50	083170105
6	30	27	30	083170106
8	36	34	20	083170108
10	42	37	10	083170110

8020

thimbles, italian light type,
galvanized

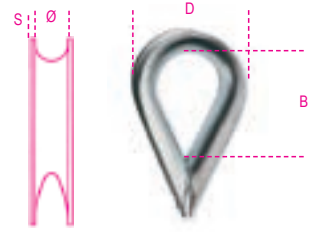

AVAILABLE CERTIFICATES

- Technical product specifications
- Test report UNI EN10204 type 2.2

Ø mm	S mm	B mm	D mm		
2-3	0,8	20	20	350	080200003
4	1,0	22	21	300	080200004
5	1,0	23	24	300	080200005
6	1,0	27	29	200	080200006
8	1,2	33	33	180	080200008
10	1,5	40	39	100	080200010
12	1,8	44	46	120	080200012
14	2,0	49	50	100	080200014
16	2,0	57	59	150	080200016
18	2,5	68	69	100	080200018
20	3,0	78	77	70	080200020
22	3,0	88	84	60	080200022
24	3,5	92	91	40	080200025

special packaging

Ø mm	S mm			
2-3	0,8	150	1	080200703
4	1,0	150	1	080200704
5	1,0	100	1	080200705
6	1,0	100	1	080200706
8	1,2	50	1	080200708
10	1,5	30	1	080200710

8021

thimbles, heavy type,
galvanized

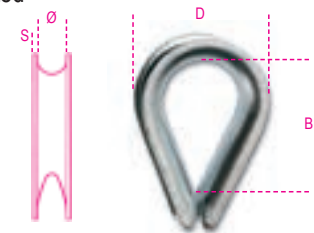

AVAILABLE CERTIFICATES

- Technical product specifications
- Test report UNI EN10204 type 2.2

Ø mm	S mm	B mm	D mm		
2-3	0,6	15	16	150	080210003
5	1,7	29	28	120	080210005
6	1,8	33	30	100	080210006
8	2,5	36	37	100	080210008
10	2,5	42	43	80	080210010
12	2,5	48	50	100	080210012
14	2,7	58	57	70	080210014
16	3,0	61	62	50	080210016
18	3,5	71	71	70	080210018
20	4,0	79	79	60	080210020
22	4,0	87	84	50	080210022
24	4,0	93	92	40	080210024
26	4,0	103	103	35	080210026
28	5,0	107	116	1	080210028
30	5,0	118	121	1	080210030
32	5,5	138	135	1	080210032
35	6,0	140	147	1	080210035
40	6,0	173	170	1	080210040

8025

lifting LARGE DEE shackles,
hot forged carbon steel,
galvanized

CE



GRADO 4

TECHNICAL DATA

- safety factor: 5
 - heat treatment: normalizing
 - traceability code
- ### LABORATORY TESTS
- chemical analysis
 - metallographic analysis
 - tensile test

AVAILABLE CERTIFICATES

- Technical product specifications
- Test report UNI EN10204 type 2.2
- Inspection certificate UNI EN10204 type 3.1
- CE Declaration of Conformity

Ø mm	≈ "	B x C mm	WLL kg		
5	3/16	21x10	70	250	080250005
6	1/4	25x12	100	250	080250006
8	5/16	33x16	250	150	080250008
10	3/8	42x20	400	180	080250010
11	7/16	46x22	500	130	080250011
12	1/2	50x24	600	100	080250012
14	9/16	57x28	800	70	080250014
16	5/8	61x32	1000	10	080250016
18	11/16	65x36	1300	10	080250018
20	3/4	70x40	1600	10	080250020
22	7/8	74x44	2000	10	080250022
25	1"	80x48	2800	2	080250025



special packaging

Ø mm	≈ "			
5	3/16	25	1	080250705
6	1/4	25	1	080250706
8	5/16	25	1	080250708
10	3/8	15	1	080250710
11	7/16	12	1	080250711
12	1/2	12	1	080250712
14	9/16	10	1	080250714

8026A

lifting DEE shackles,
hot forged carbon steel,
UNI 1947 type A, galvanized

CE

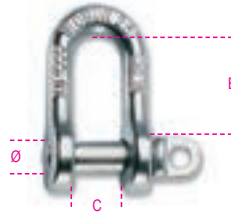

GRADO 4

TECHNICAL DATA

- safety factor: 5
 - heat treatment: normalizing
 - traceability code
- ### LABORATORY TESTS
- chemical analysis
 - metallographic analysis
 - tensile test

AVAILABLE CERTIFICATES

- Technical product specifications
- Test report UNI EN10204 type 2.2
- Inspection certificate UNI EN10204 type 3.1
- CE Declaration of Conformity

Ø mm	≈ "	B x C mm	WLL kg		
12	1/2	42x20	630	35	080260012
14	9/16	46x22	800	30	080260014
16	5/8	50x24	1000	20	080260016
18	11/16	54x26	1300	15	080260018
20	3/4	58x28	1600	10	080260020
22	7/8	69x32	2000	10	080260022
25	1"	79x36	2500	5	080260025
28	1.1/8	90x40	3150	2	080260028
32	1.1/4	100x45	4000	1	080260032
36	1.3/8	110x50	5000	1	080260036
40	1.9/16	120x55	6300	1	080260040
42	1.5/8	131x60	8000	1	080260042
45	1.3/4	143x65	10000	1	080260045
50	2"	155x70	12500	1	080260050

8026R

straight shackles with screw collar pin,
high-tensile alloy steel, GRADE 6,
hot-dipped galvanized body

CE

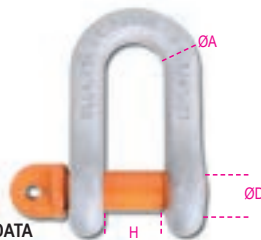

EN 13889
GRADE 6

TECHNICAL DATA

- minimum safety factor: 6
 - heat treatment: hardening and tempering
 - traceability code on both pin and body
- ### LABORATORY TESTS

- chemical analysis • metallographic analysis
- tensile test • fatigue test (min. 20,000 cycles)
- proof load test (2 x WLL)

AVAILABLE CERTIFICATES

- Technical Product Specifications
- Test Report UNI EN10204 type 2.2
- Inspection Certificate UNI EN10204 type 3.1
- CE Declaration of Conformity

ØA mm	ØD mm	H mm	WLL kg		
13	16	21	2000	5	080260212
16	19	27	3250	3	080260216
19	22	32	4750	2	080260219
22	25	37	6500	2	080260222

8531

dee FISHING shackles,
hot-dip galvanized

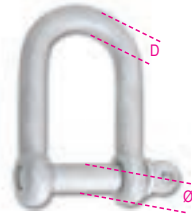

AVAILABLE CERTIFICATES

- Test report UNI EN10204 type 2.2

Ø mm	D mm	WFL kg		
20	18	1600	1	085310018
22	20	2500	1	085310020

8532

dee FISHING shackles
with square head screw pin,
black painted



AVAILABLE CERTIFICATES

- Test report UNI EN10204 type 2.2

Ø mm	D mm	WFL kg		
20	20	1600	1	085320020
22	22	2500	1	085320022

8028

lifting BOW shackles,
hot forged carbon steel,
galvanized

CE



GRADO 4

TECHNICAL DATA

- safety factor: 5
 - heat treatment: normalizing
 - traceability code
- ### LABORATORY TESTS
- chemical analysis
 - metallographic analysis
 - tensile test

AVAILABLE CERTIFICATES

- Technical product specifications
- Test report UNI EN10204 type 2.2
- Inspection certificate UNI EN10204 type 3.1
- CE Declaration of Conformity

Ø mm	≈ "	B x C mm	WLL kg		
5	3/16	20x16	80	100	080280105
6	1/4	24x20	100	70	080280106
8	5/16	32x24	200	35	080280108
10	3/8	40x33	300	25	080280110
12	1/2	48x39	500	15	080280112
14	9/16	56x46	600	7	080280114
16	5/8	64x46	800	10	080280116

Robur

Ø mm	B x C mm	WLL kg		
18	11/16	71x59	950	5 080280118
20	3/4	80x65	1100	5 080280120
22	7/8	88x72	1500	5 080280122
25	1"	100x81	2000	2 080280125
28	1 1/8	112x91	2600	1 080280128
32	1 1/4	128x104	3200	1 080280132
38	1 1/2	152x124	4500	1 080280138

8029R

bow shackles with screw collar pins,
high-tensile alloy steel, GRADE 6,
hot-dipped galvanized body

CE

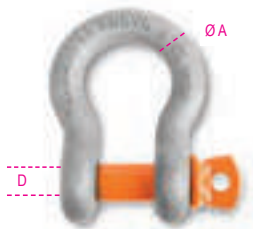

EN 13889
GRADO 6

TECHNICAL DATA

- minimum safety factor: 6
- heat treatment: hardening and tempering
- traceability code on pin and body

LABORATORY TESTS

- chemical analysis
- metallographic analysis
- tensile test
- fatigue test (min. 20,000 cycles)
- proof load test (2 x WLL)

AVAILABLE CERTIFICATES

- Technical Product Specifications
- Test Report UNI EN10204 type 2.2
- Inspection Certificate UNI EN10204 type 3.1
- CE Declaration of Conformity

	ØA mm	ØD mm	WLL kg		
8029R	6	8	500	20	080290106
8029R	8	10	750	15	080290108
8029R	10	11	1000	15	080290110
8029R	11	13	1500	10	080290111
8029R	13	16	2000	8	080290112
8029R	16	19	3250	5	080290116
8029R	19	22	4750	2	080290120
8029R	22	25	6500	2	080290122
8029R	26	28	8500	1	080290124
8029R	29	32	9500	1	080290128
8029R	32	35	12000	1	080290132
8029R	35	38	13500	1	080290135
8029R	38	42	17000	1	080290138
8029R	45	50	25000	1	080290145
8029R	50	50	35000	1	080290150
8029R	57	57	42500	1	080290157
8029R	65	65	55000	1	080290165

8032

bow shackles with square sunken hole screw
pin,
high-tensile alloy steel, GRADE 6,
hot-dip galvanized body

CE

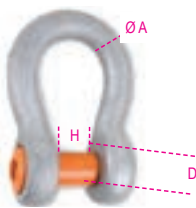

GRADE 6

TECHNICAL DATA

- minimum safety factor: 6
- heat treatment: hardening and tempering
- traceability code on pin and body

LABORATORY TESTS

- chemical analysis
- metallographic analysis
- tensile test
- fatigue test (min. 20,000 cycles)
- proof load test (2 x WLL)

AVAILABLE CERTIFICATES

- Technical Product Specifications
- Test Report UNI EN10204 type 2.2
- Inspection Certificate UNI EN10204 type 3.1
- CE Declaration of Conformity

ØA mm	ØD mm	H mm	WLL kg		
13	16	21	2000	5	080320012
16	19	27	3250	3	080320016
19	22	32	4750	2	080320020
22	25	37	6500	2	080320022

8031R

bow shackles with safety bolt, EN13889
high-tensile alloy steel, GRADE 6,
hot-dip galvanized body

CE



EN 13889
GRADO 6

TECHNICAL DATA

- minimum safety factor: 6
- heat treatment: hardening and tempering
- traceability code on pin and body

LABORATORY TESTS

- chemical analysis
- metallographic analysis
- tensile test
- fatigue test (min. 20,000 cycles)
- proof load test (2 x WLL)

AVAILABLE CERTIFICATES

- Technical Product Specifications
- Test Report UNI EN10204 type 2.2
- Inspection Certificate UNI EN10204 type 3.1
- CE Declaration of Conformity

	ØD mm	ØA mm	H mm	WLL kg		
8031R	13	11	18	1500	5	080310111
8031R	16	13	21	2000	5	080310112
8031R	19	16	27	3250	3	080310116
8031R	22	19	32	4750	2	080310120
8031R	25	22	37	6500	2	080310122
8031R	28	26	43	8500	1	080310124
8031R	32	29	48	9500	1	080310128
8031R	35	32	53	12000	1	080310132
8031R	38	35	59	13500	1	080310135
8031R	42	38	62	17000	1	080310138
8031R	50	45	75	25000	1	080310145
8031R	57	50	83	35000	1	080310150
8031R	70	65	105	55000	1	080310165
8031R	83	75	127	85000	1	080310183

DIN 580 / 582 : 2010				
	WLL I kg	WLL II kg	WLL III kg	WLL IV kg
*M6	30	30	30	30
M8	140	140	140	95
M10	230	230	230	150
M12	340	340	340	230
*M14	480	480	480	335
M16	720	720	720	495
*M18	920	920	920	635
M20	1200	1200	1200	845
*M22	1450	1450	1450	1025
M24	1820	1820	1820	1270
*M27	2400	2400	2400	1665
M30	3200	3200	3200	2280
*M33	3800	3800	3800	2755
M36	4600	4600	4600	3250
M42	6300	6300	6300	4455
M48	8600	8600	8600	6090
M56	11500	11500	11500	8130
M64	16000	15500	16000	11310

8040EZ

lifting eye bolts, DIN 580
galvanized

CE

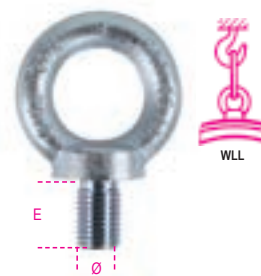

DIN 580:2010-09

TECHNICAL DATA

- safety factor: 6
- heat treatment: normalizing
- traceability code

LABORATORY TESTS

- chemical analysis
- metallographic analysis
- tensile test

AVAILABLE CERTIFICATES

- Technical product specifications
- Test report UNI EN10204 type 2.2
- Inspection certificate UNI EN10204 type 3.1
- CE Declaration of Conformity

	Ø mm	E mm	WLL kg		
* M6	1	11	90	60	080400406
M8	1,25	13	140	60	080400408
M10	1,5	17	230	40	080400410
M12	1,75	20,5	340	20	080400412
* M14	2	20,5	480	20	080400414
M16	2	27	700	10	080400416
* M18	2,5	27	930	10	080400418
M20	2,5	30	1200	10	080400420
* M22	2,5	30	1450	10	080400422
M24	3	36	1800	5	080400424
* M27	3	41	2400	5	080400427
M30	3,5	45	3200	2	080400430
* M33	3,5	54	3900	2	080400433
* M33F	2	54	3900	2	080400434
M36	4	54	4600	2	080400436
* M36F	3	54	4600	2	080400437
M42	4,5	63	6300	1	080400442
* M42F	3	63	6300	1	080400443
M48	5	68	8600	1	080400448
* M48F	3	68	8600	1	080400449
M56	5,5	78	11500	1	080400456
* M56F	4	78	11500	1	080400457
M64	6	90	16000	1	080400464
* M64F	4	90	16000	1	080400465

*Sizes not included in DIN standard

Robur

8040EN

lifting eye bolts, DIN 580
self-coloured

CE



DIN 580:2010-09

TECHNICAL DATA

- safety factor: 6
- heat treatment: normalizing
- traceability code

LABORATORY TESTS

- chemical analysis
- metallographic analysis

AVAILABLE CERTIFICATES

- Technical product specifications
- Test report UNI EN10204 type 2.2
- Inspection certificate UNI EN10204 type 3.1
- CE Declaration of Conformity

Ø mm	⌀ mm	E mm	WLL kg		
* M6	1	11	90	60	080400306
M8	1,25	13	140	60	080400308
M10	1,5	17	230	40	080400310
M12	1,75	20,5	340	20	080400312
* M14	2	20,5	480	20	080400314
M16	2	27	700	10	080400316
* M18	2,5	27	930	10	080400318
M20	2,5	30	1200	10	080400320
* M22	2,5	30	1450	10	080400322
M24	3	36	1800	5	080400324
* M27	3	41	2400	5	080400327
M30	3,5	45	3200	2	080400330
* M33	3,5	54	3900	2	080400333
* M33F	2	54	3900	2	080400334
M36	4	54	4600	2	080400336
* M36F	3	54	4600	2	080400337
M42	4,5	63	6300	1	080400342
* M42F	3	63	6300	1	080400343
M48	5	68	8600	1	080400348
* M48F	3	68	8600	1	080400349
M56	5,5	78	11500	1	080400356
* M56F	4	78	11500	1	080400357
M64	6	90	16000	1	080400364
* M64F	4	90	16000	1	080400365

*Sizes not included in DIN standard

DIN 580 / 582 : 2010				
	WLL I	WLL II	WLL III	WLL IV
	kg	kg	kg	kg
* M6	90	90	90	90
M8	140	140	140	95
M10	230	230	230	160
M12	340	340	340	240
* M14	480	480	480	320
M16	700	700	700	490
* M18	930	930	930	605
M20	1200	1200	1200	840
* M22	1450	1450	1450	1025
M24	1800	1800	1800	1270
* M27	2400	2400	2400	1665
M30	3200	3200	3200	2260
* M33	3900	3900	3900	2755
M36	4600	4600	4600	3250
M42	6300	6300	6300	4455
M48	8600	8600	8600	6000
M56	11500	11500	11500	8130
M64	16000	15500	16000	11310

8042EZ

lifting eye nuts, DIN 582
galvanized

CE

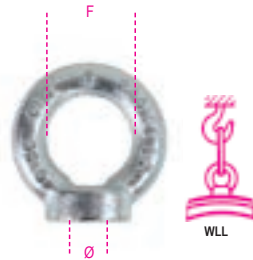

DIN 582:2010-09

TECHNICAL DATA

- safety factor: 6
- heat treatment: normalizing
- traceability code

LABORATORY TESTS

- chemical analysis
- metallographic analysis

AVAILABLE CERTIFICATES

- Technical product specifications
- Test report UNI EN10204 type 2.2
- Inspection certificate UNI EN10204 type 3.1
- CE Declaration of Conformity

Ø mm	⌀ mm	F mm	WLL kg		
* M6	1	14	90	60	080420406
M8	1,25	20	140	60	080420408
M10	1,5	25	230	40	080420410
M12	1,75	30	340	30	080420412
* M14	2	30	480	30	080420414
M16	2	35	700	20	080420416
* M18	2,5	35	930	20	080420418
M20	2,5	40	1200	10	080420420
* M22	2,5	40	1450	10	080420422
M24	3	50	1800	5	080420424
* M27	3	55	2400	5	080420427
M30	3,5	60	3200	3	080420430
M36	4	70	4600	2	080420436
* M36F	3	70	4600	2	080420437
M42	4,5	80	6300	1	080420442
* M42F	3	80	6300	1	080420443
M48	5	90	8600	1	080420448
* M48F	3	90	8600	1	080420449

*Sizes not included in DIN standard

8042EN

lifting eye nuts, DIN 582
self-coloured

CE



DIN 582:2010-09

TECHNICAL DATA

- safety factor: 6
- heat treatment: normalizing
- traceability code

LABORATORY TESTS

- chemical analysis
- metallographic analysis

AVAILABLE CERTIFICATES

- Technical product specifications
- Test report UNI EN10204 type 2.2
- Inspection certificate UNI EN10204 type 3.1
- CE Declaration of Conformity

Ø mm	⌀ mm	F mm	WLL kg		
* M6	1	14	90	60	080420306
M8	1,25	20	140	60	080420308
M10	1,5	25	230	40	080420310
M12	1,75	30	340	30	080420312
* M14	2	30	480	30	080420314
M16	2	35	700	20	080420316
* M18	2,5	35	930	20	080420318
M20	2,5	40	1200	10	080420320
* M22	2,5	40	1450	10	080420322
M24	3	50	1800	5	080420324
* M27	3	55	2400	5	080420327
M30	3,5	60	3200	3	080420330
M36	4	70	4600	2	080420336
* M36F	3	70	4600	2	080420337
M42	4,5	80	6300	1	080420342
* M42F	3	80	6300	1	080420343
M48	5	90	8600	1	080420348
* M48F	3	90	8600	1	080420349

*Sizes not included in DIN standard

Robur

Robur
INOX
STAINLESS STEEL

576

8044

lifting eye nuts, UNI 2948
self-coloured

CE



UNI 2948

TECHNICAL DATA

- safety factor: 4
- heat treatment: normalizing
- traceability code

LABORATORY TESTS

- chemical analysis
- metallographic analysis
- tensile test

AVAILABLE CERTIFICATES

- Technical product specifications
- Test report UNI EN10204 type 2.2
- Inspection certificate UNI EN10204 type 3.1
- CE Declaration of Conformity

Ø	WLL		
mm	kg		
M8	1,25	80	4 080440008
M10	1,5	160	4 080440010
M12	1,75	250	4 080440012
M14	2	250	2 080440014
M16	2	400	2 080440016
M20	2,5	630	2 080440020
M24	3	1000	2 080440024

8041

lifting eyebolts,
high-tensile alloy steel

CE



TECHNICAL DATA

- safety factor: 4
- heat treatment: hardening and tempering
- traceability code

LABORATORY TESTS

- chemical analysis
- metallographic analysis
- tensile test
- fatigue test (20,000 cycles)
- proof load test (100% of batch)

AVAILABLE CERTIFICATES

- Technical product specifications
- Test report UNI EN10204 type 2.2
- Inspection certificate UNI EN10204 type 3.1
- CE Declaration of Conformity

Ø	E	WLL		
mm	mm	kg		
* M8	1,25	13	600	10 080410208
* M10	1,5	17	800	6 080410210
* M12	1,75	20,5	1300	4 080410212
* M16	2	27	3200	2 080410216
* M20	2,5	30	4800	2 080410220
* M24	3	36	6500	2 080410224
* M30	3,5	45	9500	1 080410230

(*) Dimensional specifications DIN 580:2010
WLL increased according to Robur Technical Product Specifications

8043

lifting eye nuts,
high-tensile alloy steel

CE



TECHNICAL DATA

- safety factor: 4
- heat treatment: hardening and tempering
- traceability code

LABORATORY TESTS

- chemical analysis
- metallographic analysis
- tensile test
- fatigue test (20,000 cycles)
- proof load test (100% of batch)

AVAILABLE CERTIFICATES

- Technical product specifications
- Test report UNI EN10204 type 2.2
- Inspection certificate UNI EN10204 type 3.1
- CE Declaration of Conformity

Ø	F	WLL		
mm	mm	kg		
* M8	1,25	20	600	10 080430208
* M10	1,50	25	800	6 080430210
* M12	1,75	30	1300	4 080430212
* M16	2	35	3200	2 080430216
* M20	2,5	40	4800	2 080430220
* M24	3	50	6500	2 080430224
* M30	3,5	60	9500	1 080430230

(*) Dimensional specifications DIN 582:2010
WLL increased according to Robur Technical Product Specifications

8049

adjustable lifting eyebolts,
double swivel ring,
high-tensile alloy steel

CE

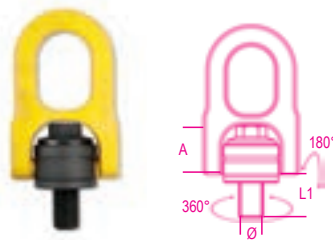

TECHNICAL DATA

- safety factor: 5
- heat treatment: hardening and tempering
- traceability code

LABORATORY TESTS

- chemical analysis
- metallographic analysis
- tensile test
- fatigue test (20,000 cycles)

AVAILABLE CERTIFICATES

- Technical product specifications
- Test report UNI EN10204 type 2.2
- Inspection certificate UNI EN10204 type 3.1
- CE Declaration of Conformity

Ø	A	L1	WLL		
mm	mm	mm	kg		
M8	31,5	14	300	1 080490008	
M10	31,5	17	600	1 080490010	
M12	31,5	21	1000	1 080490012	
M16	45	27	1600	1 080490016	
M20	45	30	2500	1 080490020	
M24	60,5	36	4000	1 080490024	
M30	60,5	45	6300	1 080490030	

8049 WLL (t)

	A°	M8	M10	M12	M16	M20	M24	M30
	0°	0,3	0,6	1	1,6	2,5	4	6,3
	0°	0,6	1,2	2	3,2	5	8	12,6
	90°	0,3	0,6	1	1,6	2,5	4	6,3
	90°	0,6	1,2	2	3,2	5	8	12,6
	0°/45°	0,4	0,8	1,4	2,2	3,5	5,6	8,8
	46°/60°	0,3	0,6	1	1,6	2,5	4	6,3
	0°/45°	0,6	1,3	2,1	3,4	5,3	8,4	13,2
	46°/60°	0,3	0,6	1	1,6	2,3	4	6,3

8048

eye tie rods right thread
self-coloured



UNI 6058

ØxL	WFL	F		
mm	kg	mm		
M8x50	430	6	1	080480108
M8x65	430	6	1	080480109
M10x80	690	8	1	080480110
M10x100	690	8	1	080480210
M10x130	690	8	1	080480111
M12x70	1020	10	1	080480212
M12x95	1020	10	1	080480112
M12x125	1020	10	1	080480113
M14x110	1420	12	1	080480114
M16x100	1980	14	1	080480115
M16x130	1980	14	1	080480116
M18x150	2390	16	1	080480118
M20x160	3100	18	1	080480120
M22x180	3890	18	1	080480122
M24x200	4460	20	1	080480124
M24x220	4460	20	1	080480125
M27x220	5900	22	1	080480127

8074

carabine hooks,
galvanized

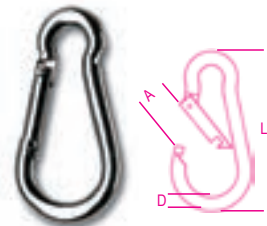

DIN 5299

TECHNICAL DATA

- safety factor: 4
- ### AVAILABLE CERTIFICATES
- Technical product specifications
 - Test report UNI EN10204 type 2.2

DxL	A	WFL		
mm	mm	kg		
* 4x40	6	20	100	080740040
5x50	7	30	100	080740050
6x60	8	40	100	080740060
7x70	9	60	50	080740070
8x80	11	75	50	080740080
9x90	12	100	25	080740090
10x100	13	120	25	080740100
11x120	16	140	20	080740101
12x140	22	140	15	080740102
13x160	24	200	10	080740103
* 14x180	32	250	5	080740104

8074A

ring carabine hooks,
galvanized

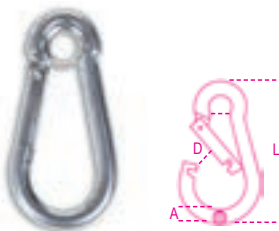

DIN 5299

TECHNICAL DATA

• safety factor: 4

AVAILABLE CERTIFICATES

- Technical product specifications
- Test report UNI EN10204 type 2.2

øAxL mm	D mm	WFL kg		
5x50	7,4	30	50	080740405
6x60	8,7	40	50	080740406
8x80	10,5	75	25	080740408
10x100	13,3	120	10	080740410

8074G

carabine hooks with screw nut,
galvanized

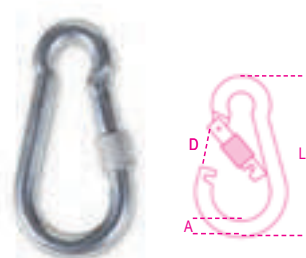

TECHNICAL DATA

• safety factor: 4

AVAILABLE CERTIFICATES

- Technical product specifications
- Test report UNI EN10204 type 2.2

øAxL mm	D mm	WFL kg		
5x50	7,5	30	50	080740305
6x60	8,5	40	50	080740306
8x80	10,3	75	25	080740308
10x100	10,6	120	10	080740310

8080

quick links,
galvanized

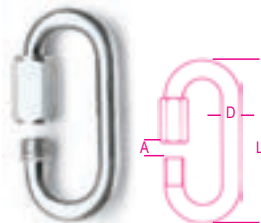

TECHNICAL DATA

• safety factor: 4

AVAILABLE CERTIFICATES

- Technical product specifications
- Test report UNI EN10204 type 2.2

DxL mm	A mm	WFL kg		
3,5x36	5	20	100	080800003
4x40	6	30	100	080800004
5x49	6	50	100	080800005
6x57	8	60	100	080800006
7x66	8	100	50	080800007

DxL mm	A mm	WFL kg		
8x74	11	140	50	080800008
9x80	11	160	25	080800009
10x89	11	220	25	080800010
12x105	15	300	20	080800012
14x125	16,5	400	3	080800014

8082

rings
galvanised steel

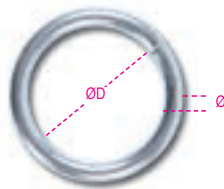

Ø mm	ØD mm		
4	20	50	080820004
5	30	20	080820005
6	40	10	080820006
7	50	5	080820007
8	60	5	080820008

8083

S-hooks
galvanised steel



Ø mm	L mm		
3	33	40	080830003
4	40	30	080830004
5	47	20	080830005
6	59	15	080830006
8	79	5	080830008

8114

eye and eye swivels,
italian "Marche" type,
carbon steel, galvanized

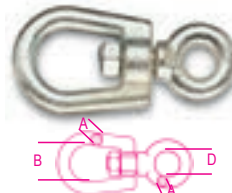

TECHNICAL DATA

• safety factor: 4

• traceability code

LABORATORY TESTS

• tensile test

AVAILABLE CERTIFICATES

- Technical product specifications
- Test report UNI EN10204 type 2.2

A mm	B mm	D mm	WFL kg		
8	30	16	250	1	081140008
10	38	18	300	1	081140010
12	42	20	650	1	081140012
14	48	22	820	1	081140014
16	57	24	1000	1	081140016
18	64	26	1600	1	081140018
20	72	30	2000	1	081140020
22	80	34	2500	1	081140022

8116

eye and eye swivels,
carbon steel, galvanized

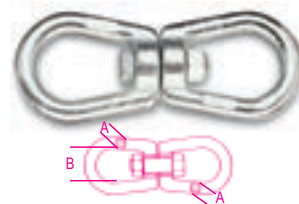

TECHNICAL DATA

• safety factor: 4

• traceability code

LABORATORY TESTS

• tensile test

AVAILABLE CERTIFICATES

- Technical product specifications
- Test report UNI EN10204 type 2.2

A mm	B mm	WFL kg		
6	23	140	1	081160006
8	30	250	1	081160008
10	38	300	1	081160010
12	42	650	1	081160012
14	48	820	1	081160014
16	57	1000	1	081160016
18	64	1600	1	081160018
20	72	2000	1	081160020
22	80	2500	1	081160022

8120

Genovese chains
for static connections,
galvanised



TECHNICAL DATA

• safety factor: 4

AVAILABLE CERTIFICATES

- Technical product specifications
- Test report UNI EN10204 type 2.2

Ø mm	nr	WFL kg	m		
1,5	10	8	150	1	081200015
1,6	12	15	150	1	081200016
2,2	14	25	75	1	081200022
2,7	16	40	75	1	081200027
3,0	17	55	75	1	081200030
3,4	18	100	60	1	081200034
3,8	19	110	50	1	081200038
4,4	20	200	40	1	081200044
4,8	21	250	30	1	081200048
5,5	22	300	25	1	081200055
5,8	23	310	25	1	081200058
6,5	24	400	25	1	081200065
7,5	26	550	20	1	081200075
* 8,0	27	600	25	1	081200080
* 9,0	28	800	25	1	081200090
* 10,0	30	1000	20	1	081200100
* 12,0	32	1400	15	1	081200120

Caution: product NOT designed for lifting purposes

(*) available in COILS

8120B

Genovese chains for static connections, galvanised



TECHNICAL DATA

- safety factor: 4
- AVAILABLE CERTIFICATES
- Technical product specifications
- Test report type 2.2 UNI EN10204

Ø mm	nr	WFL	m	kg	1	1
1,5	10	8	200		1	081200315
1,6	12	15	200		1	081200316
2,2	14	25	100		1	081200322
2,7	16	40	100		1	081200327
3,0	17	55	75		1	081200330
3,4	18	100	100		1	081200334
3,8	19	110	75		1	081200338
4,4	20	200	50		1	081200344
4,8	21	250	50		1	081200348
5,5	22	300	40		1	081200355
5,8	23	310	30		1	081200358
6,5	24	400	30		1	081200365
7,5	26	550	25		1	081200375
8,0	27	600	15		1	081200380
9,0	28	800	15		1	081200390
10,0	30	1000	10		1	081200400
12,0	32	1400	8		1	081200420

Caution: NOT for lifting

8129

barrier chain, made of galvanized metal painted in red and white

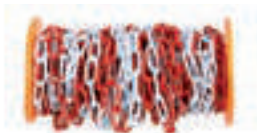

Ø mm	m	1	1
5	30	1	081290050

Caution: NOT for lifting or anchoring

8130

antitheft chains, made of alloy steel, case-hardened, tempered, galvanised



Ø mm	L mm	1	1
6	800	1	081300068
8	1000	1	081300081
8	1200	1	081300082
10	1500	1	081300105

8130A

anti-theft chains with rings, made of alloy steel, case-hardened, tempered, galvanised



Ø mm	L mm	1	1
10	900	1	081300209

8131Z

antitheft chains with padlocks



Ø mm	L mm	8139Z Ø mm	1	1
6	800	8	1	081310060
6	800	10	1	081310068
8	1000	10	1	081310081
8	1200	10	1	081310082
10	1500	10	1	081310105

8131DL

disc lock with anti-theft chain 8130A



Ø mm	L mm	1	1
10	900	1	081310209

8139DL

motorcycle disc locks, made of hardened steel, shockproof PVC, blister-packed

- supplied with 3 keys, signalling cable, case
- suitable for 10mm chains



Ø mm	L mm	H mm	1	1
14	108	56	1	081390214

8139Z

padlocks for antitheft chains, zinc alloy bodies

- supplied with 3 mapped keys
- suitable for chains 6, 8, 10 mm



Ø mm	L mm	H mm	1	1
8	45	90	1	081390008
10	55	98	1	081390009

8139ZCH

3 neutral spare keys for locks 8139Z



1	1
1	081390090

suitable for locks ø8 and ø10

8302Z

fastening eye bolts, right thread, galvanized



TECHNICAL DATA

- safety factor: 4
- AVAILABLE CERTIFICATES
- Technical product specifications
- Test report UNI EN10204 type 2.2

Ø mm	E mm	F mm	WFL kg	1	1
M5	48	8	115	200	083020005
M6	55	10	160	150	083020006
M8	60	12	300	100	083020008
M10	73	14	470	100	083020010
M12	90	17	690	50	083020012

8303Z

fastening hooks right thread, galvanized



TECHNICAL DATA

- safety factor: 4
- AVAILABLE CERTIFICATES
- Technical product specifications
- Test report UNI EN10204 type 2.2

Ø mm	C mm	E mm	WFL kg	1	1
M5	6,0	48	25	120	083030005
M6	8,0	55	45	100	083030006
M8	10,0	60	95	75	083030008
M10	12,5	73	140	50	083030010
M12	16,0	90	220	20	083030012

8381SL

U bolts for pipes, light type, galvanized

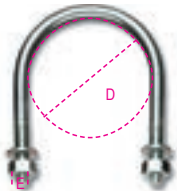

AVAILABLE CERTIFICATES

- Technical product specifications
- Test report UNI EN10204 type 2.2

D mm	D gas	E mm		
11	1/8"	M6	100	083810201
14	1/4"	M6	100	083810202
18	3/8"	M6	100	083810203
22	1/2"	M6	100	083810204
27	3/4"	M6	100	083810205
34	1"	M6	100	083810206
43	1 1/4"	M6	100	083810207
49	1 1/2"	M8	50	083810208
61	2"	M8	50	083810209
77	2 1/2"	M8	25	083810210
89	3"	M8	25	083810211
102	3 1/2"	M8	25	083810212
115	4"	M8	25	083810213
168	6"	M10	25	083810218
220	8"	M10	10	083810220

8381SP

U bolts for pipes, heavy type, galvanized

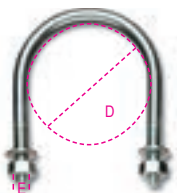

AVAILABLE CERTIFICATES

- Technical product specifications
- Test report UNI EN10204 type 2.2

D mm	D gas	E mm		
22	1/2"	M8	100	083810301
27	3/4"	M8	100	083810302
34	1"	M8	100	083810303
43	1 1/4"	M8	100	083810304
49	1 1/2"	M10	25	083810305
61	2"	M10	25	083810306
77	2 1/2"	M10	25	083810307
89	3"	M10	25	083810308
102	3 1/2"	M12	25	083810309
115	4"	M12	15	083810310
168	6"	M16	15	083810315
220	8"	M16	10	083810320
274	10"	M16	1	083810374
324	12"	M20	1	083810386
408	16"	M24	1	083810508

8383C

square U bolts, hot galvanized
Flanged nuts

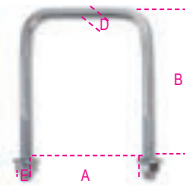

AVAILABLE CERTIFICATES

- Technical Product Specifications
- Test Report UNI EN10204 type 2.2

A mm	E mm	B mm	D mm		
70	M10	110	8,55	130	083830070
80	M10	120	8,55	110	083830080
90	M10	130	8,55	100	083830090
100	M10	155	8,55	90	083830100
120	M10	175	8,55	70	083830120

8383P

plates for square U bolts hot galvanized

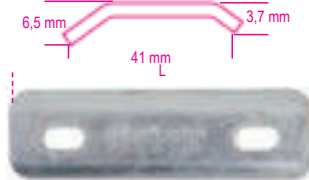

AVAILABLE CERTIFICATES

- Technical product specifications
- Test report UNI EN10204 type 2.2

	L mm		
8383P 150	150	150	083830214
8383C/70-80 /90-100			
8383P 170	170	120	083830217
8383C/100-120			

8515Z

wire tenders, galvanized



Available Certificates

- Test Report UNI EN10204 type 2.2

D mm	H mm	L mm		
20	25	93	50	085150002
24,5	30	100	50	085150003

8515V

wire tenders, galvanized and painted



Available Certificates

- Test Report UNI EN10204 type 2.2

D mm	H mm	L mm		
20	25	93	50	085150102
24,5	30	100	50	085150103

8515CH

wire tender keys, galvanized



L mm	OA mm	OB mm		
90	8	7,5	20	085150901

8535

fishing hooks, galvanized

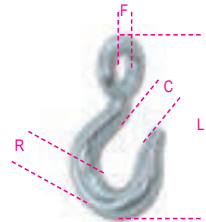

AVAILABLE CERTIFICATES

- Test report UNI EN10204 type 2.2

R mm	C mm	F mm	L mm		
26	27,5	34	156	1	085350006
30	36,5	40	185	1	085350007

8051S

lifting eye hooks, carbon steel, galvanized



GRADO 4

TECHNICAL DATA

- safety factor: 4
 - heat treatment: normalizing
 - traceability code
- LABORATORY TESTS
- chemical analysis
 - metallographic analysis
 - tensile test

AVAILABLE CERTIFICATES

- Technical product specifications
- Test report UNI EN10204 type 2.2
- Inspection certificate UNI EN10204 type 3.1
- CE Declaration of Conformity

WLL kg	C mm	F mm		
250	14	12	10	080510202
500	18	16,5	5	080510205

8052 - 8055S

wire rope eye hooks,
high-tensile alloy steel

CE



EN 1677-2

TECHNICAL DATA

- safety factor: 4
- heat treatment: hardening and tempering
- traceability code

LABORATORY TESTS

- chemical analysis, metallographic analysis
- tensile test
- fatigue test (min. 20,000 cycles)
- proof load test (2 x WLL)

AVAILABLE CERTIFICATES

- Technical Product Specifications
- Test Report UNI EN10204 type 2.2
- Inspection Certificate UNI EN10204 type 3.1
- CE Declaration of Conformity

	WLL kg	C mm		
8052	800	18	1	080520008
8052	1120	22,5	1	080520011
8052	2000	30	1	080520020
8052	3150	36	1	080520031
8052	4000	39,5	1	080520040

	WLL kg	C mm		
8055S	5400	32	1	080550145
8055S	8000	43	1	080550170
8055S	11500	53	1	080550215
8055S	16000	58	1	080550260
8055S	22000	78	1	080550320

8057R - 8057

self-locking lifting hooks,
eye type,
high-tensile alloy steel

CE



EN 1677-3

TECHNICAL DATA

- safety factor: 4
- heat treatment: hardening and tempering
- traceability code

LABORATORY TESTS

- chemical analysis, metallographic analysis
- tensile test
- fatigue test (min. 20,000 cycles)
- proof load test (100% of batch)

AVAILABLE CERTIFICATES

- Technical product specifications
- Test report UNI EN10204 type 2.2
- Inspection certificate UNI EN10204 type 3.1
- CE Declaration of Conformity

	WLL kg	C mm	J min mm		
8057R	2000	7-8	34	1	080570120
8057R	3150	10	44	1	080570132

	WLL kg	C mm	J mm		
8057	5300	13	54	1	080570053

8058R - 8058

self-locking lifting hooks,
Clevis type,
high-tensile alloy steel

CE



EN 1677-3

TECHNICAL DATA

- safety factor: 4
- heat treatment: hardening and tempering
- traceability code

LABORATORY TESTS

- chemical analysis, metallographic analysis
- tensile test
- fatigue test (min. 20,000 cycles)
- proof load test (100% of batch)

AVAILABLE CERTIFICATES

- Technical product specifications
- Test report UNI EN10204 type 2.2
- Inspection certificate UNI EN10204 type 3.1
- CE Declaration of Conformity

	WLL kg	Ø mm	J min mm		
8058R	1120	6	28	1	080580112
8058R	2000	7-8	34	1	080580120
8058R	3150	10	44	1	080580132
8058R	5300	13	52	1	080580153

	WLL kg	Ø mm	J min mm		
8058	8000	16	67	1	080580080

8060R - 8060

Clevis chain hooks,
high-tensile alloy steel

CE



EN 1677-2

TECHNICAL DATA

- safety coefficient: 4
- heat treatment: hardening and tempering
- Traceability code on pin, safety latch, body

LABORATORY TESTS

- chemical analysis, metallographic analysis
- proof load test (WLL x 2.5)
- tensile test
- fatigue test (min. 20,000 cycles)

AVAILABLE CERTIFICATES

- Technical Product Specifications
- Test Report UNI EN10204 type 2.2
- Inspection Certificate UNI EN10204 type 3.1
- CE Declaration of Conformity

	WLL kg	Ø mm	C mm		
8060R	1120	6	19	1	080600111
8060R	1500	7	19	1	080600115
8060R	2000	8	21	1	080600120
8060R	3150	10	27	1	080600132
8060R	5300	13	35	1	080600153

	WLL kg	Ø mm	C mm		
8060	8000	16	48	1	080600080

8061R - 8061F

Clevis grab hooks
with safety latch,
high-tensile alloy steel

CE



EN 1677-1

TECHNICAL DATA

- safety factor: 4
- heat treatment: hardening and tempering
- traceability code

LABORATORY TESTS

- chemical analysis, metallographic analysis
- tensile test
- fatigue test (min. 20,000 cycles)
- proof load test (100% of batch)

AVAILABLE CERTIFICATES

- Technical product specifications
- Test report UNI EN10204 type 2.2
- Inspection certificate UNI EN10204 type 3.1
- CE Declaration of Conformity

	WLL kg	Ø mm	E mm		
8061R	1120	6	8	1	080610211
8061R	2000	7-8	11	1	080610220
8061R	3150	10	13	1	080610231

	WLL kg	Ø mm	E mm		
8061F	5300	13	16,5	1	080610153
8061F	8000	16	20,5	1	080610180

8062

slip hooks
alloy steel, painted

CE

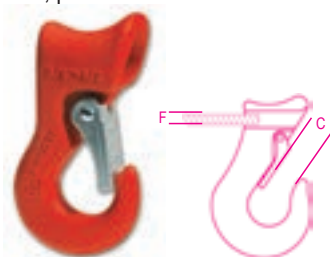

TECHNICAL DATA

- safety factor: 5
- heat treatment: hardening and tempering
- traceability code

LABORATORY TESTS

- chemical analysis, metallographic analysis
- proof load test (WLL x 2.5)
- tensile test

AVAILABLE CERTIFICATES

- Technical product specifications
- Test report UNI EN10204 type 2.2
- Inspection certificate UNI EN10204 type 3.1
- CE Declaration of Conformity

	WLL kg	C mm	F mm		
1500	19	10-13		1	080620013
2000	21	16		1	080620016
3000	26	18		1	080620018
5000	34	22-25		1	080620025

Robur

8063

lifting swivel hooks
(in unloaded condition)
high-tensile alloy steel

CE

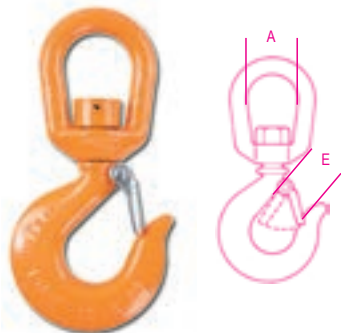

EN 1677-1

TECHNICAL DATA

- safety factor: 4
 - heat treatment: hardening and tempering
 - traceability code
- ### LABORATORY TESTS
- chemical analysis, metallographic analysis
 - tensile test
 - fatigue test (min. 20,000 cycles)
 - proof load test (100% of batch)

AVAILABLE CERTIFICATES

- Technical Product Specifications
- Test report UNI EN10204 type 2.2
- Inspection certificate UNI EN10204 type 3.1
- CE Declaration of Conformity

WLL	A	E		
kg	mm	mm		
800	32	20,5	1	080630008
1120	38	20,5	1	080630011
2000	44,5	22	1	080630020
3150	44,5	27	1	080630031

8064S

swivel lifting hooks
(not under load)
carbon steel, painted

CE

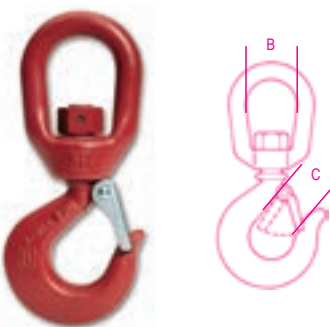

EN 1677-5

TECHNICAL DATA

- safety factor: 5
 - heat treatment: hardening and tempering
 - traceability code
- ### LABORATORY TESTS
- chemical analysis, metallographic analysis
 - proof load test (WLL x 2.5)
 - tensile test
 - fatigue test (min. 20,000 cycles)

AVAILABLE CERTIFICATES

- Technical product specifications
- Test report UNI EN10204 type 2.2
- Inspection certificate UNI EN10204 type 3.1
- CE Declaration of Conformity

WLL	B	C		
kg	mm	mm		
800	31	20	1	080640107
1000	40	22	1	080640110
1600	47	23	1	080640115
2000	47	27	1	080640120
3200	64	35	1	080640130
5000	77	43	1	080640150
7500	90	53	1	080640175
10000	96	58	1	080640199

8065SC

swivel load lifting hooks
carbon steel, painted

CE

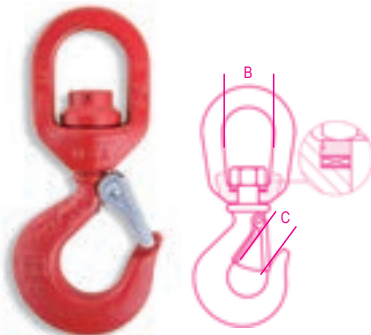

EN 1677-5

TECHNICAL DATA

- safety factor: 5
 - heat treatment: hardening and tempering
 - traceability code
- ### LABORATORY TESTS
- chemical analysis, metallographic analysis
 - proof load test (WLL x 2.5)
 - tensile test
 - fatigue test (min. 20,000 cycles)

AVAILABLE CERTIFICATES

- Technical product specifications
- Test report UNI EN10204 type 2.2
- Inspection certificate UNI EN10204 type 3.1
- CE Declaration of Conformity

WLL	B	C		
kg	mm	mm		
800	38	20	1	080650107
1000	38	22	1	080650110
1600	47	23	1	080650115
2000	47	27	1	080650120
3200	54	35	1	080650130
5000	72	43	1	080650150
7500	82	53	1	080650175

8050D

safety locks and spare parts kit for eye hooks



8050D1	1	080500945
8064S-8065SC/800		
8050D2	1	080500946
8064S-8065SC/1000		
8050D3	1	080500947
8064S-8065SC/1600-2000		
8050D4	1	080500948
8055S/5400 - 8064S-8065SC/3200		
8050D5	1	080500949
8055S/8000		
8064S-8065SC/5000		
8050D6	1	080500950
8055S/11500		
8064S/7500		
8050D10	1	080500954
8062/1500		
8050D11	1	080500955
8062/2000		
8050D12	1	080500956
8062/3000		
8050D13	1	080500957
8062/5000		
8050D22	1	080500966
8055S/16000		
8064S/10000		
8050D23	1	080500967
8055S/22000		
8050D24	1	080500969
8051S/250		
8050D25	1	080500970
8051S/500		
8050D29	1	080500974
8061F/5300		
8050D30	1	080500975
8061F/8000		

8050D32	1	080500977
8060/8000		
8050D33	1	080500978
8052/800		
8050D34	1	080500979
8052/1120		
8050D35	1	080500980
8052/2000		
8050D36	1	080500981
8052/3150		
8050D37	1	080500982
8052/4000		
8050D38	1	080500983
8060R/1120		
8050D39	1	080500984
8060R/2000		
8050D40	1	080500985
8060R/3150		
8050D41	1	080500986
8060R/5300		
8050D42	1	080500987
8063/800		
8050D43	1	080500988
8063/1120		
8050D44	1	080500989
8063/2000		
8050D45	1	080500990
8063/3150		



8050D46	1	080500991
8061R/1120		
8050D47	1	080500992
8061R/2000		
8050D48	1	080500993
8061R/3150		



8050 D53	1	080500849
8057R/1120 - 8058R/1120		
8050 D50	1	080500850
8057R/2000 - 8058R/2000		
8050 D51	1	080500851
8057R/3150 - 8058R/3150		
8050 D52	1	080500852
8057R/5300 - 8058R/5300		

8058R/PS

pin kit for hooks item 8058R-861R



Ø mm		
8058R/PS 6	1	080580512
8058R/PS 7-8	1	080580520
8058R/PS 10	1	080580532
8058R/PS 13	1	080580553

8060R/PS

pin kit for hooks item 8060R



Ø mm		
8060R/PS 6	1	080600511
8060R/PS 7	1	080600515
8060R/PS 8	1	080600520
8060R/PS 10	1	080600532
8060R/PS 13	1	080600553

Robur

8085

lifting master links
alloy steel, painted

WLL means the use with 1 chain sling.

CE



EN 1677-4

TECHNICAL DATA

- safety factor: 4
- heat treatment: hardening and tempering
- traceability code

LABORATORY TESTS

- chemical analysis, metallographic analysis
- proof load test (WLL x 2.5)
- tensile test

- fatigue test (min. 20,000 cycles)

AVAILABLE CERTIFICATES

- Technical product specifications
- Test report UNI EN10204 type 2.2
- Inspection certificate UNI EN10204 type 3.1
- CE Declaration of Conformity

WLL kg	Ø mm	B mm	C mm	1	2
* 1500	7	110	60	1	080850016
2000	8	110	60	1	080850020
3150	10	135	75	1	080850032
5300	13	160	90	1	080850054
8000	16	180	100	1	080850080
11200	19	200	110	1	080850190

* If you match it with a chain 6mm in Ø, WLL= 1120 kg

8086

lifting master link assemblies
alloy steel, painted

* WLL means the use with 3 or 4 chain slings
and β angle < 45°.

CE



EN 1677-4

TECHNICAL DATA

- safety factor: 4
- heat treatment: hardening and tempering
- traceability code

LABORATORY TESTS

- chemical analysis, metallographic analysis
- proof load test (WLL x 2.5)
- tensile test

- fatigue test (min. 20,000 cycles)

AVAILABLE CERTIFICATES

- Technical product specifications
- Test report UNI EN10204 type 2.2
- Inspection certificate UNI EN10204 type 3.1
- CE Declaration of Conformity

WLL kg	Ø mm	B mm	C mm	1	2
* 3150	7	135	75	1	080860021
4250	8	160	90	1	080860042
6700	10	180	100	1	080860067
11200	13	200	110	1	080860100
17000	16	260	140	1	080860117

*If you match it with a chain 6 mm in Ø, WLL=2360 Kg.

8090R - 8090

lifting connecting links
alloy steel, painted

CE

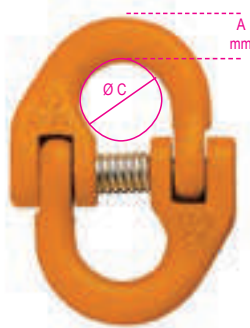

EN 1677-1

TECHNICAL DATA

- safety factor: 4
- heat treatment: hardening and tempering
- traceability code

LABORATORY TESTS

- chemical analysis, metallographic analysis
- proof load test (WLL x 2.5)
- tensile test

- fatigue test (min. 20,000 cycles)

AVAILABLE CERTIFICATES

- Technical product specifications
- Test report UNI EN10204 type 2.2
- Inspection certificate UNI EN10204 type 3.1
- CE Declaration of Conformity

WLL kg	Ø mm	Ø C max mm	A mm	1	2	
8090R	6	1120	13	7,5	1	080900111
8090R	7	1500	18	9	1	080900115
8090R	8	2000	18	11	1	080900120
8090R	10	3150	22	13,0	1	080900131
8090R	13	5300	30	16	1	080900153

WLL kg	Ø mm	Ø C max mm	A mm	1	2	
8090	8000	16	32	22	1	080900080

8090F

lifting connecting links for polyester slings,
alloy steel, painted

CE

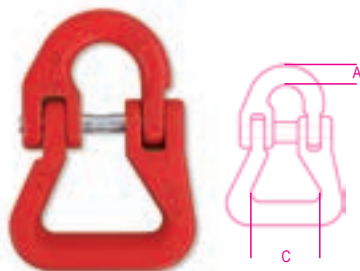

EN 1677-1

TECHNICAL DATA

- safety factor: 4
- heat treatment: hardening and tempering
- traceability code

LABORATORY TESTS

- chemical analysis, metallographic analysis
- proof load test (WLL x 2.5)
- tensile test

- fatigue test (min. 20,000 cycles)

AVAILABLE CERTIFICATES

- Technical product specifications
- Test report UNI EN10204 type 2.2
- Inspection certificate UNI EN10204 type 3.1
- CE Declaration of Conformity

WLL kg	Ø mm	A mm	C mm	1	2
2000	7-8	10,5	40	1	080900220
3150	10	12	50	1	080900232
5300	13	17	60	1	080900253
8000	16	21	75	1	080900280

8100

lifting chains,
high-tensile alloy steel

CE

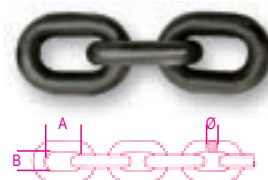

EN 818-2

TECHNICAL DATA

- safety factor: 4
- heat treatment: hardening and tempering
- traceability code

LABORATORY TESTS

- chemical analysis
- metallographic analysis
- tensile test

AVAILABLE CERTIFICATES

- Technical Product Specifications
- Test Report UNI EN10204 type 2.2
- Manufacturer's Certificate EN818-2
- CE Declaration of Conformity

WLL kg	Ø mm	A mm	B min mm	1	2
1120	6	18	7,8	1	081000011
1500	7	21	9,1	1	081000016
2000	8	24	10,4	1	081000020
3150	10	30	13	1	081000032
5300	13	39	16,9	1	081000053
8000	16	48	20,8	1	081000080

CHAIN SLINGS Grade 8

WLL Ton

UNI EN 818

Ø D mm	WLL 1	WLL 2	
		0° < β ≤ 45°	45° < β ≤ 60°
6	1,12	1,6	1,12
7	1,5	2,12	1,5
8	2	2,8	2
10	3,15	4,25	3,15
13	5,3	7,5	5,3
16	8	11,2	8

Ø D mm	WLL 1	WLL 3	
		0° < β ≤ 45°	45° < β ≤ 60°
6	2,36	1,7	
7	3,15	2,34	
8	4,25	3	
10	6,7	4,75	
13	11,2	8	
16	17	11,2	

8091

lifting chain slings, 1 leg
grade 8

CE

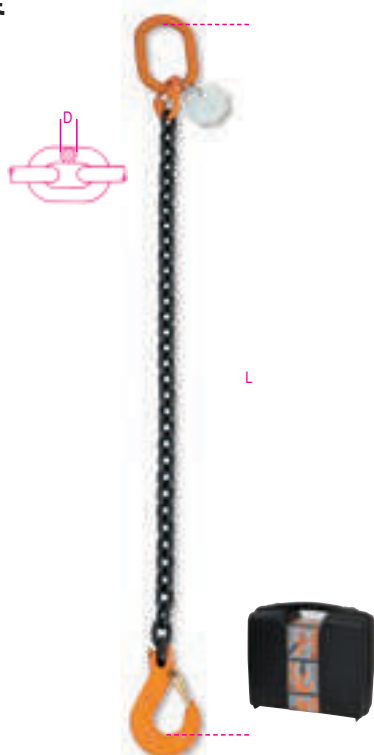

UNI EN 818-4

TECHNICAL DATA

- safety factor: 4
 - chain-sling identification tag
- ATTACHED CERTIFICATES**
- Manufacturer's Certificate UNI EN818-4
 - CE Declaration of Conformity
- AVAILABLE CERTIFICATES**
- Technical product specifications

D mm	L m	WLL ton		
6*	1	1,12	1	080910001
6*	2	1,12	1	080910002
6*	3	1,12	1	080910003
6*	4	1,12	1	080910004
7*	1	1,5	1	080910021
7*	2	1,5	1	080910022
7*	3	1,5	1	080910023
7*	4	1,5	1	080910024
8*	1	2	1	080910041
8*	2	2	1	080910042
8*	3	2	1	080910043
8*	4	2	1	080910044
10*	1	3,15	1	080910051
10*	2	3,15	1	080910052
10*	3	3,15	1	080910053
10*	4	3,15	1	080910054
13*	1	5,3	1	080910131
13*	2	5,3	1	080910132
13*	3	5,3	1	080910133
13*	4	5,3	1	080910134
16*	1	8	1	080910161
16*	2	8	1	080910162
16*	3	8	1	080910163
16*	4	8	1	080910164

* packed in plastic case

Robur

8091SL

lifting chain slings,
1 leg, self-locking hook,
grade 8

CE



UNI EN 818-4

TECHNICAL DATA

- safety factor: 4
 - chain-sling identification tag
- ATTACHED CERTIFICATES**
- Manufacturer's Certificate UNI EN818-4
 - CE Declaration of Conformity
- AVAILABLE CERTIFICATES**
- Technical product specifications

D mm	L m	WLL ton		
6*	1	1,12	1	080910201
6*	2	1,12	1	080910202
6*	3	1,12	1	080910203
6*	4	1,12	1	080910204
7*	1	1,5	1	080910221
7*	2	1,5	1	080910222
7*	3	1,5	1	080910223
7*	4	1,5	1	080910224
8*	1	2	1	080910241
8*	2	2	1	080910242
8*	3	2	1	080910243
8*	4	2	1	080910244
10*	1	3,15	1	080910251
10*	2	3,15	1	080910252
10*	3	3,15	1	080910253
10*	4	3,15	1	080910254
13*	1	5,3	1	080910331
13*	2	5,3	1	080910332
13*	3	5,3	1	080910333
13*	4	5,3	1	080910334
16*	1	8	1	080910361
16*	2	8	1	080910362
16*	3	8	1	080910363
16*	4	8	1	080910364

* Packed in plastic case

8092

lifting chains sling, 2 legs
grade 8

CE



UNI EN 818-4

TECHNICAL DATA

- safety factor: 4
 - chain-sling identification tag
- ATTACHED CERTIFICATES**
- Manufacturer's Certificate UNI EN818-4
 - CE Declaration of Conformity
- AVAILABLE CERTIFICATES**
- Technical product specifications

D mm	L m	WLL ton		
6*	1	1,6	1	080920001
6*	2	1,6	1	080920002
6*	3	1,6	1	080920003
6*	4	1,6	1	080920004
7*	1	2,12	1	080920021
7*	2	2,12	1	080920022
7*	3	2,12	1	080920023
7*	4	2,12	1	080920024
8*	1	2,8	1	080920041
8*	2	2,8	1	080920042
8*	3	2,8	1	080920043
8*	4	2,8	1	080920044
10*	1	4,25	1	080920051
10*	2	4,25	1	080920052
10*	3	4,25	1	080920053
10*	4	4,25	1	080920054
13*	1	7,5	1	080920131
13*	2	7,5	1	080920132
13	3	7,5	1	080920133
13	4	7,5	1	080920134
16*	1	11,2	1	080920161
16	2	11,2	1	080920162
16	3	11,2	1	080920163
16	4	11,2	1	080920164

* packed in plastic case

Robur

8092SL

lifting chain slings,
2 legs, self-locking hook,
grade 8

CE



UNI EN 818-4

TECHNICAL DATA

- safety factor: 4
 - chain-sling identification tag
- ATTACHED CERTIFICATES**
- Manufacturer's Certificate UNI EN818-4
 - CE Declaration of Conformity
- AVAILABLE CERTIFICATES**
- Technical product specifications

D mm	L m	WLL ton		
6*	1	1,6	1	080920201
6*	2	1,6	1	080920202
6*	3	1,6	1	080920203
6*	4	1,6	1	080920204
7*	1	2,12	1	080920221
7*	2	2,12	1	080920222
7*	3	2,12	1	080920223
7*	4	2,12	1	080920224
8*	1	2,8	1	080920241
8*	2	2,8	1	080920242
8*	3	2,8	1	080920243
8*	4	2,8	1	080920244
10*	1	4,25	1	080920251
10*	2	4,25	1	080920252
10*	3	4,25	1	080920253
10*	4	4,25	1	080920254
13*	1	7,5	1	080920331
13*	2	7,5	1	080920332
13*	3	7,5	1	080920333
13*	4	7,5	1	080920334
16*	1	11,2	1	080920361
16*	2	11,2	1	080920362
16*	3	11,2	1	080920363
16*	4	11,2	1	080920364

* Packed in plastic case



8094

lifting chain sling, 4 legs
grade 8

CE



UNI EN 818-4

TECHNICAL DATA

- safety factor: 4
 - chain-sling identification tag
- ATTACHED CERTIFICATES**
- Manufacturer's Certificate UNI EN818-4
 - CE Declaration of Conformity
- AVAILABLE CERTIFICATES**
- Technical product specifications

D mm	L m	WLL ton		
6*	1	2,36	1	080940001
6*	2	2,36	1	080940002
6*	3	2,36	1	080940003
6*	4	2,36	1	080940004
7*	1	3,15	1	080940021
7*	2	3,15	1	080940022
7*	3	3,15	1	080940023
7*	4	3,15	1	080940024
8*	1	4,25	1	080940041
8*	2	4,25	1	080940042
8*	3	4,25	1	080940043
8	4	4,25	1	080940044
10*	1	6,7	1	080940051
10	2	6,7	1	080940052
10	3	6,7	1	080940053
10	4	6,7	1	080940054
13	1	11,2	1	080940131
13	2	11,2	1	080940132
13	3	11,2	1	080940133
13	4	11,2	1	080940134
16	1	17	1	080940161
16	2	17	1	080940162
16	3	17	1	080940163
16	4	17	1	080940164

* packed in plastic case

8094SL

lifting chain slings,
4 legs, self-locking hook,
grade 8

CE



UNI EN 818-4

TECHNICAL DATA

- safety factor: 4
 - chain-sling identification tag
- ATTACHED CERTIFICATES**
- Manufacturer's Certificate UNI EN818-4
 - CE Declaration of Conformity
- AVAILABLE CERTIFICATES**
- Technical product specifications

D mm	L m	WLL ton		
6*	1	2,36	1	080940201
6*	2	2,36	1	080940202
6*	3	2,36	1	080940203
6*	4	2,36	1	080940204
7*	1	3,15	1	080940221
7*	2	3,15	1	080940222
7*	3	3,15	1	080940223
7*	4	3,15	1	080940224
8*	1	4,25	1	080940241
8*	2	4,25	1	080940242
8*	3	4,25	1	080940243
8	4	4,25	1	080940244
10*	1	6,7	1	080940251
10	2	6,7	1	080940252
10	3	6,7	1	080940253
10	4	6,7	1	080940254
13	1	11,2	1	080940331
13	2	11,2	1	080940332
13	3	11,2	1	080940333
13	4	11,2	1	080940334
16	1	17	1	080940361
16	2	17	1	080940362
16	3	17	1	080940363
16	4	17	1	080940364

* Packed in plastic case



8096

lifting chain sling, 1 leg
with clevis grab hook,
grade 8

CE



UNI EN 818-4

TECHNICAL DATA

- safety factor: 4
 - chain-sling identification tag
- ATTACHED CERTIFICATES**
- Manufacturer's Certificate UNI EN818-4
 - CE Declaration of Conformity
- AVAILABLE CERTIFICATES**
- Technical product specifications

D mm	L m	WLL ton		
6*	1	1,12	1	080960001
6*	2	1,12	1	080960002
6*	3	1,12	1	080960003
6*	4	1,12	1	080960004
7*	1	1,5	1	080960021
7*	2	1,5	1	080960022
7*	3	1,5	1	080960023
7*	4	1,5	1	080960024
8*	1	2	1	080960041
8*	2	2	1	080960042
8*	3	2	1	080960043
8*	4	2	1	080960044
10*	1	3,15	1	080960051
10*	2	3,15	1	080960052
10*	3	3,15	1	080960053
10*	4	3,15	1	080960054
13*	1	5,3	1	080960131
13*	2	5,3	1	080960132
13*	3	5,3	1	080960133
13*	4	5,3	1	080960134
16*	1	8	1	080960161
16*	2	8	1	080960162
16*	3	8	1	080960163
16	4	8	1	080960164

* packed in plastic case

Robur

Robur

8096SL

lifting chain slings,
1 leg, with self-locking and clevis grab hooks,
grade 8

CE



UNI EN 818-4

TECHNICAL DATA

- safety factor: 4
 - chain-sling identification tag
- ATTACHED CERTIFICATES**
- Manufacturer's Certificate UNI EN818-4
 - CE Declaration of Conformity
- AVAILABLE CERTIFICATES**
- Technical product specifications

D mm	L m	WLL ton		
6*	1	1,12	1	080960201
6*	2	1,12	1	080960202
6*	3	1,12	1	080960203
6*	4	1,12	1	080960204
7*	1	1,5	1	080960221
7*	2	1,5	1	080960222
7*	3	1,5	1	080960223
7*	4	1,5	1	080960224
8*	1	2	1	080960241
8*	2	2	1	080960242
8*	3	2	1	080960243
8*	4	2	1	080960244
10*	1	3,15	1	080960251
10*	2	3,15	1	080960252
10*	3	3,15	1	080960253
10*	4	3,15	1	080960254
13*	1	5,3	1	080960331
13*	2	5,3	1	080960332
13*	3	5,3	1	080960333
13*	4	5,3	1	080960334
16*	1	8	1	080960361
16*	2	8	1	080960362
16*	3	8	1	080960363
16	4	8	1	080960364

* Packed in plastic case

8097

lifting chain sling, 2 legs
with clevis grab hooks,
grade 8

CE



UNI EN 818-4

TECHNICAL DATA

- safety factor: 4
 - chain-sling identification tag
- ATTACHED CERTIFICATES**
- Manufacturer's Certificate UNI EN818-4
 - CE Declaration of Conformity
- AVAILABLE CERTIFICATES**

- Technical product specifications

D mm	L m	WLL ton		
6*	1	1,6	1	080970001
6*	2	1,6	1	080970002
6*	3	1,6	1	080970003
6*	4	1,6	1	080970004
7*	1	2,12	1	080970021
7*	2	2,12	1	080970022
7*	3	2,12	1	080970023
7*	4	2,12	1	080970024
8*	1	2,8	1	080970041
8*	2	2,8	1	080970042
8*	3	2,8	1	080970043
8*	4	2,8	1	080970044
10*	1	4,25	1	080970051
10*	2	4,25	1	080970052
10*	3	4,25	1	080970053
10*	4	4,25	1	080970054
13*	1	7,5	1	080970131
13*	2	7,5	1	080970132
13	3	7,5	1	080970133
13	4	7,5	1	080970134
16	1	11,2	1	080970161
16	2	11,2	1	080970162
16	3	11,2	1	080970163
16	4	11,2	1	080970164

* packed in plastic case

Robur

8097SL

lifting chain slings,
2 legs, with self-locking and clevis grab hooks,
grade 8

CE



UNI EN 818-4

TECHNICAL DATA

- safety factor: 4
- chain-sling identification tag
- ATTACHED CERTIFICATES
- Manufacturer's Certificate UNI EN818-4
- CE Declaration of Conformity
- AVAILABLE CERTIFICATES
- Technical product specifications

D mm	L m	WLL ton		
6*	1	1,6	1	080970201
6*	2	1,6	1	080970202
6*	3	1,6	1	080970203
6*	4	1,6	1	080970204
7*	1	2,12	1	080970221
7*	2	2,12	1	080970222
7*	3	2,12	1	080970223
7*	4	2,12	1	080970224
8*	1	2,8	1	080970241
8*	2	2,8	1	080970242
8*	3	2,8	1	080970243
8*	4	2,8	1	080970244
10*	1	4,25	1	080970251
10*	2	4,25	1	080970252
10*	3	4,25	1	080970253
10*	4	4,25	1	080970254
13*	1	7,5	1	080970331
13*	2	7,5	1	080970332
13	3	7,5	1	080970333
13	4	7,5	1	080970334
16	1	11,2	1	080970361
16	2	11,2	1	080970362
16	3	11,2	1	080970363
16	4	11,2	1	080970364

* Packed in plastic case

Robur

8098

lifting chain sling, 4 legs
with clevis grab hooks,
grade 8

CE



UNI EN 818-4

TECHNICAL DATA

- safety factor: 4
- chain-sling identification tag
- ATTACHED CERTIFICATES
- Manufacturer's Certificate UNI EN818-4
- CE Declaration of Conformity
- AVAILABLE CERTIFICATES
- Technical product specifications

D mm	L m	WLL ton		
6*	1	2,36	1	080980001
6*	2	2,36	1	080980002
6*	3	2,36	1	080980003
6*	4	2,36	1	080980004
7*	1	3,15	1	080980021
7*	2	3,15	1	080980022
7*	3	3,15	1	080980023
7*	4	3,15	1	080980024
8*	1	4,25	1	080980041
8*	2	4,25	1	080980042
8*	3	4,25	1	080980043
8	4	4,25	1	080980044
10*	1	6,7	1	080980051
10	2	6,7	1	080980052
10	3	6,7	1	080980053
10	4	6,7	1	080980054
13	1	11,2	1	080980131
13	2	11,2	1	080980132
13	3	11,2	1	080980133
13	4	11,2	1	080980134
16	1	17	1	080980161
16	2	17	1	080980162
16	3	17	1	080980163
16	4	17	1	080980164

* packed in plastic case

8098SL

lifting chain slings,
4 legs, with self-locking and clevis grab hooks,
grade 8

CE



UNI EN 818-4

TECHNICAL DATA

- safety factor: 4
- chain-sling identification tag
- ATTACHED CERTIFICATES
- Manufacturer's Certificate UNI EN818-4
- CE Declaration of Conformity
- AVAILABLE CERTIFICATES
- Technical product specifications

D mm	L m	WLL ton		
6*	1	2,36	1	080980201
6*	2	2,36	1	080980202
6*	3	2,36	1	080980203
6*	4	2,36	1	080980204
7*	1	3,15	1	080980221
7*	2	3,15	1	080980222
7*	3	3,15	1	080980223
7*	4	3,15	1	080980224
8*	1	4,25	1	080980241
8*	2	4,25	1	080980242
8	3	4,25	1	080980243
8*	4	4,25	1	080980244
10*	1	6,7	1	080980251
10	2	6,7	1	080980252
10	3	6,7	1	080980253
10	4	6,7	1	080980254
13	1	11,2	1	080980331
13	2	11,2	1	080980332
13	3	11,2	1	080980333
13	4	11,2	1	080980334
16	1	17	1	080980361
16	2	17	1	080980362
16	3	17	1	080980363
16	4	17	1	080980364

* Packed in plastic case

Robur

Robur

POLYESTER SLINGS

TECHNICAL DATA

- safety factor: 7
- traceability code

LABORATORY TESTS

- tensile test

AVAILABLE CERTIFICATES

- Technical product specifications
- Test report UNI EN10204 type 2.2
- Manufacturer's Certificate UNI EN1492
- CE Declaration of Conformity

				$\beta = 0^\circ + 45^\circ$	$\beta = 45^\circ + 60^\circ$
	1t	0,8t	2t	1,4t	1t
	2t	1,6t	4t	2,8t	2t
	3t	2,4t	6t	4,2t	3t
	4t	3,2t	8t	5,6t	4t
	5t	4,0t	10t	7,0t	5t
	6t	4,8t	12t	8,4t	6t
	8t	6,4t	16t	11,2t	8t
	10t	8,0t	20t	14,0t	10t

8150

lifting web slings, purple 1t
two layers with reinforced eyes
high-tenacity polyester (PES) belt

CE



UNI EN 1492-1

L m	H mm	WLL ton		
0,5	30	1	1	081500005
1	30	1	1	081500010
1,5	30	1	1	081500015
2	30	1	1	081500020
2,5	30	1	1	081500025
3	30	1	1	081500030
4	30	1	1	081500040
5	30	1	1	081500050
6	30	1	1	081500060
8	30	1	1	081500080



8153

lifting web slings, green 2t
two layers with reinforced eyes
high-tenacity polyester (PES) belt

CE



UNI EN 1492-1

L m	H mm	WLL ton		
1	60	2	1	081530010
1,5	60	2	1	081530015
2	60	2	1	081530020
2,5	60	2	1	081530025
3	60	2	1	081530030
4	60	2	1	081530040
5	60	2	1	081530050
6	60	2	1	081530060
8	60	2	1	081530080
10	60	2	1	081530100

8156

lifting web slings, yellow 3t
two layers with reinforced eyes
high-tenacity polyester (PES) belt

CE

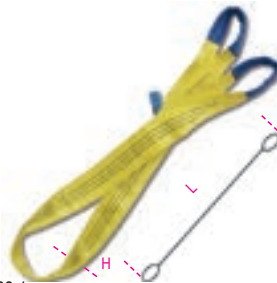

UNI EN 1492-1

L m	H mm	WLL ton		
1	90	3	1	081560010
1,5	90	3	1	081560015
2	90	3	1	081560020
2,5	90	3	1	081560025
3	90	3	1	081560030
4	90	3	1	081560040
5	90	3	1	081560050
6	90	3	1	081560060
8	90	3	1	081560080
10	90	3	1	081560100
12	90	3	1	081560120

8157

lifting web slings, grey 4t
two layers with reinforced eyes
high-tenacity polyester (PES) belt

CE



UNI EN 1492-1

L m	H mm	WLL ton		
2	120	4	1	081570020
3	120	4	1	081570030
4	120	4	1	081570040
5	120	4	1	081570050
6	120	4	1	081570060
8	120	4	1	081570080
10	120	4	1	081570100
12	120	4	1	081570120

8158

lifting web slings, red 5t
two layers with reinforced eyes
high-tenacity polyester (PES) belt

CE



UNI EN 1492-1

L m	H mm	WLL ton		
2	150	5	1	081580020
3	150	5	1	081580030
4	150	5	1	081580040
5	150	5	1	081580050
6	150	5	1	081580060
8	150	5	1	081580080
10	150	5	1	081580100
12	150	5	1	081580120

8159

lifting web slings, brown 6t
two layers with reinforced eyes
high-tenacity polyester (PES)

CE



UNI EN 1492-1

L m	H mm	WLL ton	1	2
2	180	6	1	081590020
3	180	6	1	081590030
4	180	6	1	081590040
5	180	6	1	081590050
6	180	6	1	081590060
8	180	6	1	081590080
10	180	6	1	081590100

8161

lifting web slings, orange 10t
two layers with reinforced eyes
high-tenacity polyester (PES)

CE

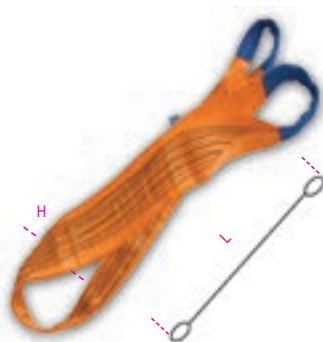

UNI EN 1492-1

L m	H mm	WLL ton	1	2
3	300	10	1	081610030
4	300	10	1	081610040
5	300	10	1	081610050
6	300	10	1	081610060
8	300	10	1	081610080
10	300	10	1	081610100
12	300	10	1	081610120

8170

lifting round slings, purple 1t
high-tenacity polyester (PES) belt

CE



UNI EN 1492-2

L m	WLL ton	H mm	1	2
0,5	1	45	1	081700010
1	1	45	1	081700020
1,5	1	45	1	081700030
2	1	45	1	081700040
3	1	45	1	081700060
4	1	45	1	081700080
5	1	45	1	081700100

8160

lifting web slings, blue 8t
two layers with reinforced eyes
high-tenacity polyester (PES)

CE



UNI EN 1492-1

L m	H mm	WLL ton	1	2
3	240	8	1	081600030
4	240	8	1	081600040
5	240	8	1	081600050
6	240	8	1	081600060
8	240	8	1	081600080
10	240	8	1	081600100

Robur

8173

lifting round slings, green 2t
high-tenacity polyester (PES) belt

CE



UNI EN 1492-2

L m	H mm	WLL ton	1	2
0,5	50	2	1	081730010
1	50	2	1	081730020
1,5	50	2	1	081730030
2	50	2	1	081730040
2,5	50	2	1	081730050
3	50	2	1	081730060
4	50	2	1	081730080
5	50	2	1	081730100
6	50	2	1	081730120
8	50	2	1	081730160

8176

lifting round slings, yellow 3t
high-tenacity polyester (PES) belt

CE



UNI EN 1492-2

L m	H mm	WLL ton	1	2
1	60	3	1	081760020
1,5	60	3	1	081760030
2	60	3	1	081760040
2,5	60	3	1	081760050
3	60	3	1	081760060
4	60	3	1	081760080
5	60	3	1	081760100
6	60	3	1	081760120
8	60	3	1	081760160

Robur

8177

lifting round slings, grey 4t
high-tenacity polyester (PES) belt

CE



UNI EN 1492-2

L m	H mm	WLL ton		
1	65	4	1	081770020
1,5	65	4	1	081770030
2	65	4	1	081770040
2,5	65	4	1	081770050
3	65	4	1	081770060
4	65	4	1	081770080
5	65	4	1	081770100
6	65	4	1	081770120
8	65	4	1	081770160

8178

lifting round slings, red 5t
high-tenacity polyester (PES) belt

CE

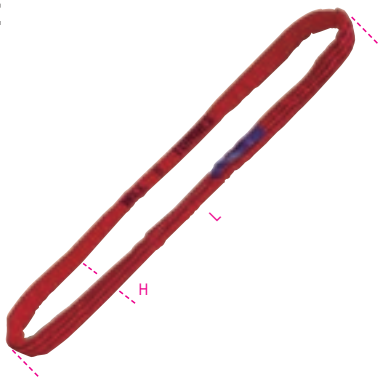

UNI EN 1492-2

L m	H mm	WLL ton		
1	70	5	1	081780020
1,5	70	5	1	081780030
2	70	5	1	081780040
2,5	70	5	1	081780050
3	70	5	1	081780060
4	70	5	1	081780080
5	70	5	1	081780100
6	70	5	1	081780120
8	70	5	1	081780160

Robur

Robur

8179M

lifting round slings, brown 6t
high-tenacity polyester (PES) belt

CE

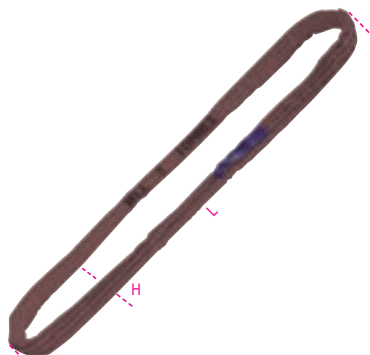

UNI EN 1492-2

L m	H mm	WLL ton		
3	80	6	1	081790060
4	80	6	1	081790080
6	80	6	1	081790120
8	80	6	1	081790160

8179B

lifting round slings, blue, 8 t,
high-tenacity polyester (PES) belt

CE

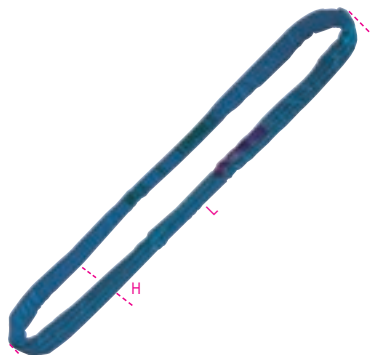

UNI EN 1492-2

L m	H mm	WLL ton		
1	85	8	1	081790220
3	85	8	1	081790260
4	85	8	1	081790280
6	85	8	1	081790320
8	85	8	1	081790360

8179A

lifting round slings, orange, 10 t,
high-tenacity polyester (PES) belt

CE

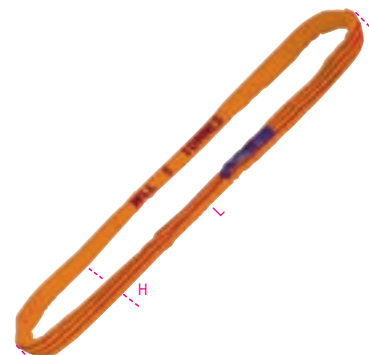

UNI EN 1492-2

L m	H mm	WLL ton		
3	95	10	1	081790506
4	95	10	1	081790508
6	95	10	1	081790512
8	95	10	1	081790516
10	95	10	1	081790520

8166

anti-abrasion sheaths for slings,
high-tenacity polyester (PES),
with elastomer underlayer



H mm	ø mm	L m		
70	45	3	1	081660073
80	52	3	1	081660083
110	70	3	1	081660103
155	100	3	1	081660153
170	110	3	1	081660170
235	150	4	1	081660235

H mm			
70	8150	8170-8173	081660073
80	8153	8176	081660083
110	8153-8156	8177-8178	081660103
155	8157	8178-8179A 8179B-8179M	081660153
170	8158	-	081660170
235	8159	-	081660235

Robur
INOX
STAINLESS STEEL



RATCHET TIE DOWNS

TECHNICAL DATA

- safety factor: 2
- traceability code

LABORATORY TESTS

- ratchet pretensioning test
 - metal parts deformation test
 - complete system tensile test
- AVAILABLE CERTIFICATES
- Technical product specifications
 - Test report UNI EN10204 type 2.2

8180

ratchet tie down with single hook, LC 750kg
high-tenacity polyester (PES) belt

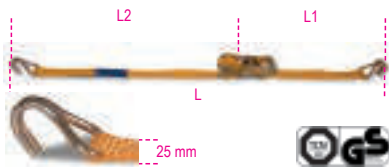

EN 12195-2

L m	L2 mm	L1 mm		
4	3750	250	1	081800004
6	5750	250	1	081800006
8	7750	250	1	081800008

LC = 750 kg

8181

ratchet tie down with single hook, LC 1000kg
high-tenacity polyester (PES) belt

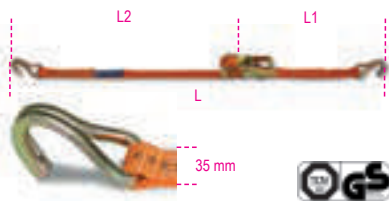

EN 12195-2

L m	L2 mm	L1 mm		
4	3600	400	1	081810004
6	5600	400	1	081810006
8	7600	400	1	081810008

LC = 1000 kg

8181S

ratchet tie down with double hook, LC 1000kg,
high-tenacity polyester (PES) belt

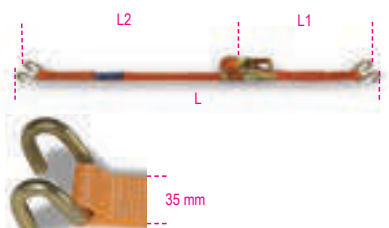

EN 12195-2

L m	L2 mm	L1 mm		
6	5600	400	1	081810206

LC = 1000 kg

8182T

ratchet tie down with double hook, LC 1500kg,
high-tenacity polyester (PES) belt

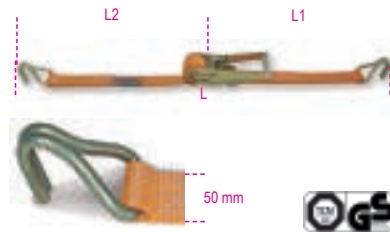

EN 12195-2

L m	L1 mm	L2 mm		
8,5	400	8100	1	081821085
10,5	400	10100	1	081821105

LC = 1500 kg

8182

ratchet tie down with single hook, LC 2000kg
high-tenacity polyester (PES) belt

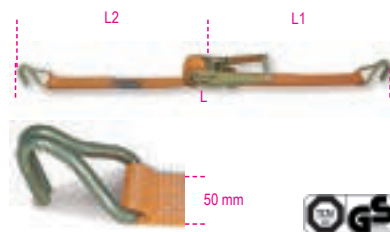

EN 12195-2

L m	L2 mm	L1 mm		
6,5	6100	400	1	081820065
8,5	8100	400	1	081820085
10,5	10100	400	1	081820105
14,5	14100	400	1	081820145
16,5	16100	400	1	081820165

LC = 2000 kg

	L2 mm		
8182LP long part	8100	1	081820902
8182SP short part		1	081820905

8182H

ratchet tie down with single hook, LC 2500kg,
high-tenacity polyester (PES) belt

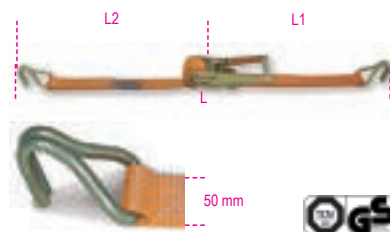

EN 12195-2

L m	L1 mm	L2 mm		
6,5	400	6100	1	081820406
8,5	400	8100	1	081820408
10,5	400	10100	1	081820410
14,5	400	14100	1	081820414

LC = 2500 kg

8182TS

ratchet tie down with single hook, LC 1500kg,
high-tenacity polyester (PES) belt

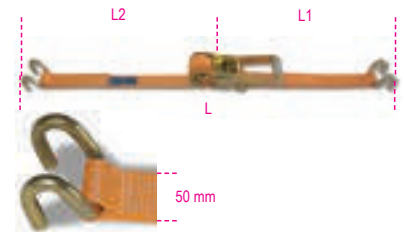

EN 12195-2

L m	L1 mm	L2 mm		
8,5	400	8100	1	081821285
10,5	400	10100	1	081821305

LC = 1500 kg

8182S

ratchet tie down with double hook, LC 2000kg
high-tenacity polyester (PES) belt

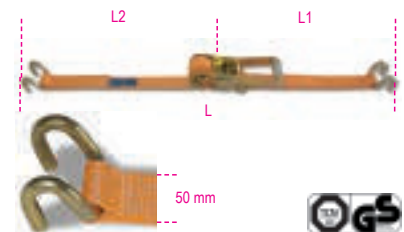

EN 12195-2

L m	L2 mm	L1 mm		
6,5	6100	400	1	081820265
8,5	8100	400	1	081820285
10,5	10100	400	1	081820305

LC = 2000 kg

	L2 mm		
8182SLP long part	8100	1	081820912
8182SSP short part		1	081820915

 **Robur**

Robur

8182A

ratchet tie downs with 2 eyes,
high-tenacity polyester (PES) belt,
LC 2000 kg



EN 12195-2

L m	L2 mm	L1 mm		
8,5	8100	400	1	081820585

LC = 2000 kg

8182E

ratchet tie downs for van and truck interiors,
LC 1000 kg,
high-tenacity polyester (PES) belt

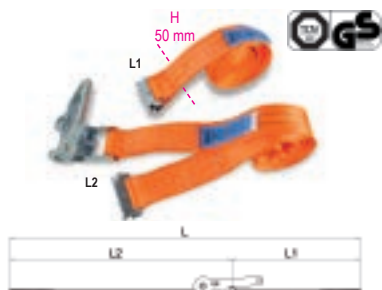

EN 12195-2

L m	L2 mm	L1 mm	H mm	
4	3500	500	50	1 081820440

LC = 1000 kg

	L2 mm		
8182EL	2500	1	081820942
8182EC		1	081820945

8185

ring ratchet tie down, LC 1500kg
high-tenacity polyester (PES) belt

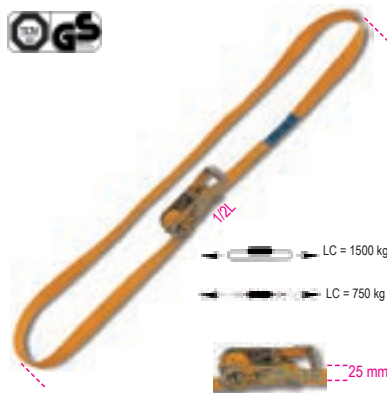

EN 12195-2

L m			
5	1	081850005	
8	1	081850008	

8186

ring ratchet tie down, LC 2000kg
high-tenacity polyester (PES) belt



EN 12195-2

L m			
5	1	081860005	
8	1	081860008	

8187

ring ratchet tie down, LC 4000kg
high-tenacity polyester (PES) belt



EN 12195-2

L m			
5	1	081870005	
8	1	081870008	

8188F

cam buckle straps, LC 200 kg,
high-grade polypropylene (PP) belt

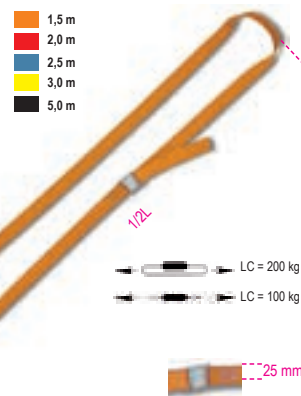

EN 12195-2

L m			
1,5	10	081880215	
2,0	10	081880220	
2,5	10	081880225	
3,0	10	081880230	
5,0	6	081880250	



8188VF/35

cam buckle straps, LC 500 kg,
high-tenacity polypropylene (PP) belt

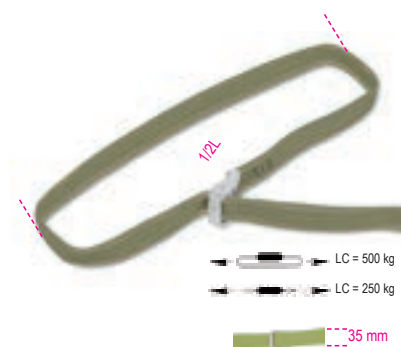

EN 12195-2

L m			
4	3	081881290	

Robur

8188C

ring ratchet tie downs, LC 750 kg,
high-tenacity polyester (PES) belt



EN 12195-2

L m		
5	3	081880350



8188CG/25

ratchet tie downs with S-hooks and Eyes,
LC 375 kg
high-tenacity polyester (PES) strap



EN 12195-2

L m	L1 mm	L2 mm	
3	480	170	1 081880430
5	480	170	1 081880450

8188CU/25

ratchet tie downs with single hooks,
LC 400 kg,
high-tenacity polyester belt (PES)

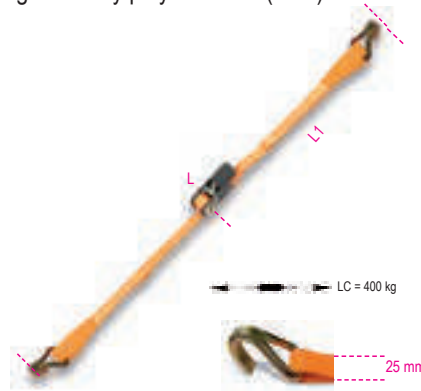

EN 12195-2

L m	L1 mm	L2 mm	
5	300	4700	1 081880750

8188VFG2

cam buckle strap with S-hooks and Eyes,
LC 250 kg
high-grade polypropylene (PP) belt



EN 12195-2

L m	L1 mm	L2 mm	
3	450	110	1 081881530

8189

polyester belt (PES)
for ratchet tie downs



H mm	L m	LC kg	
25	100	750	1 081890902
35	100	1000	1 081890903
50	100	2000	1 081890905

8189PA

2 angular guards
for polyester belts

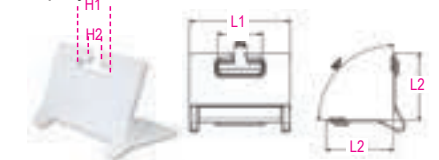

L1xL2 mm	H1 mm	H2 mm	
100x60	60	12	1 081890060
135x90	60	18	1 081890090



Breaking force (BF)
on technical specifications
WWW.ROBURITALY.COM

8201T

pipe bodies
AISI 316



LABORATORY TESTS

- chemical analysis
- tensile test

AVAILABLE CERTIFICATES

- Technical Product Specifications
- Test Report UNI EN10204 type 2.2

Ø mm	Ø "	WFL kg	L mm	
M6	1/4	160	95	5 082010406
M8	5/16	300	105	5 082010408
M10	3/8	470	125	3 082010410
M12	1/2	690	150	3 082010412
M14	9/16	940	165	1 082010414
M16	5/8	1290	190	1 082010416
M20	3/4	2130	210	1 082010420

8205

eye and eye turnbuckle
AISI 316

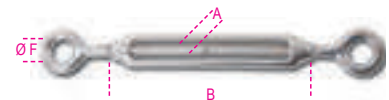

LABORATORY TESTS

- chemical analysis
- tensile test

AVAILABLE CERTIFICATES

- Technical product specifications
- Test report UNI EN10204 type 2.2

A mm	B mm	Ø F mm	WFL kg	
M4	62	8	75	10 082050204
M5	72	11	115	10 082050205
M6	92	12	160	5 082050206
M8	122	14	300	5 082050208
M10	150	16	470	1 082050210
M12	201	18	690	1 082050212
M14	225	22	940	1 082050214
M16	244	26	1290	1 082050216
M20	295	29	2130	1 082050220
M24	350	33	3000	1 082050224

8206

hook and eye turnbuckle
AISI 316

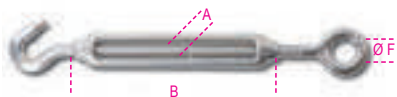

LABORATORY TESTS

- chemical analysis
- tensile test

AVAILABLE CERTIFICATES

- Technical product specifications
- Test report UNI EN10204 type 2.2

A	B	ØF	WFL		
mm	mm	mm	kg		
M5	72	11	25	10	082060205
M6	92	12	45	5	082060206
M8	122	14	95	5	082060208
M10	150	16	140	1	082060210
M12	201	18	300	1	082060212
M14	225	22	420	1	082060214
M16	244	26	570	1	082060216
M20	295	29	875	1	082060220

8207

hook and hook turnbuckle
AISI 316

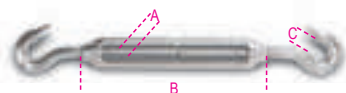

LABORATORY TESTS

- chemical analysis
- tensile test

AVAILABLE CERTIFICATES

- Technical product specifications
- Test report UNI EN10204 type 2.2

A	B	C	WFL		
mm	mm	mm	kg		
M5	72	9	25	10	082070205
M6	92	9	45	5	082070206
M8	122	10	95	5	082070208
M10	150	12	140	1	082070210
M12	201	14	300	1	082070212
M14	225	15	420	1	082070214
M16	244	16	570	1	082070216
M20	295	19	875	1	082070220

8209

jaw and jaw turnbuckle
AISI 316

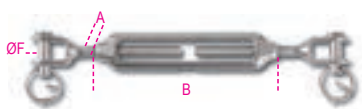

LABORATORY TESTS

- chemical analysis
- tensile test

AVAILABLE CERTIFICATES

- Technical product specifications
- Test report UNI EN10204 type 2.2

A	B	ØF	WFL		
mm	mm	mm	kg		
M5	72	5	115	5	082090205
M6	92	6	160	5	082090206
M8	122	8	300	5	082090208
M10	150	10	470	1	082090210
M12	201	12	690	1	082090212
M14	225	14	940	1	082090214
M16	244	16	1290	1	082090216
M20	295	20	2130	1	082090220
M24	350	24	3060	1	082090224

8210

jaw and jaw pipe turnbuckle
AISI 316

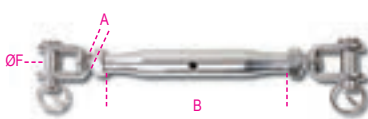

LABORATORY TESTS

- chemical analysis
- tensile test

AVAILABLE CERTIFICATES

- Technical product specifications
- Test report UNI EN10204 type 2.2

A	B	ØF	WFL		
mm	mm	mm	kg		
M5	81	5	115	3	082100205
M6	92	6	160	3	082100206
M8	112	8	300	1	082100208
M10	121	10	470	1	082100210
M12	150	12	690	1	082100212
M14	169	14	940	1	082100214
M16	190	16	1290	1	082100216
M20	220	20	2130	1	082100220

8216

wire rope clips
AISI 316

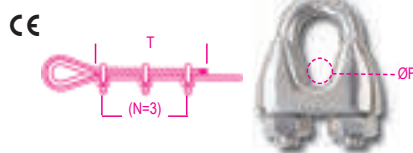

LABORATORY TESTS

- chemical analysis
- torque test

AVAILABLE CERTIFICATES

- Technical product specifications
- Test report UNI EN10204 type 2.2
- CE Certificate of Conformity

ØF	"	T	N		
mm					
2	5/64	80	3	15	082160202
3	1/8	80	3	15	082160203
4	5/32	80	3	10	082160204
5	3/16	110	3	10	082160205
6	1/4	120	5	10	082160206
8	5/16	210	5	5	082160208
10	3/8	240	5	5	082160210
12-13	1/2	300	5	5	082160213
16	5/8	335	5	5	082160216
20	3/4	540	5	5	082160220
22	7/8	595	7	3	082160222

8220

thimbles
AISI 316

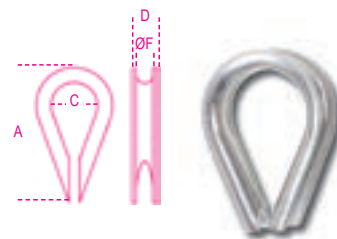

LABORATORY TESTS

- chemical analysis

AVAILABLE CERTIFICATES

- Technical product specifications
- Test report UNI EN10204 type 2.2

ØF	D	A	C		
mm	mm	mm	mm		
2	4,5	21	7,5	15	082200202
3	6	24	10	15	082200203
4	6,6	28	11	10	082200204
5	8,5	30	13	10	082200205
6	10	37	15	10	082200206
8	12,5	51	23	5	082200208
10	14,6	56	27	5	082200210
12	18	68	32	5	082200212
14	19	69	34	5	082200214
16	22	83	37	5	082200216
18	23	81	38	1	082200218
20	27,8	105	45	1	082200220
22	29,6	112	45	1	082200222

8225

dee shackles
AISI 316



LABORATORY TESTS

- chemical analysis
- tensile test

AVAILABLE CERTIFICATES

- Technical product specifications
- Test report UNI EN10204 type 2.2

ØD	"	A	WFL		
mm		mm	kg		
4	5/32	8	50	10	082250204
5	3/16	11	70	10	082250205
6	1/4	13	100	5	082250206
8	5/16	17	250	5	082250208
10	3/8	21	400	3	082250210
12	1/2	25	600	3	082250212
16	5/8	32	1000	1	082250216
19	3/4	38	1600	1	082250219
22	7/8	43	2000	1	082250222
25	1	46	2800	1	082250225

8227

long dee shackles
AISI 316



LABORATORY TESTS

- chemical analysis
- tensile test

AVAILABLE CERTIFICATES

- Technical product specifications
- Test report UNI EN10204 type 2.2

ø D mm	A mm	WFL kg		
4	5/32	8	50	10 082270204
5	3/16	10	70	10 082270205
6	1/4	13,5	100	5 082270206
8	5/16	17	250	5 082270208
10	3/8	21	400	1 082270210
12	1/2	25	600	1 082270212

8228

bow shackles
AISI 316

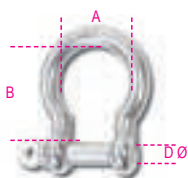

LABORATORY TESTS

- chemical analysis
- tensile test

AVAILABLE CERTIFICATES

- Technical product specifications
- Test report UNI EN10204 type 2.2

ø D mm	A mm	B mm	WFL kg		
4	13	20	60	10	082280204
5	17	23	80	10	082280205
6	20	27	100	10	082280206
8	28	36	200	5	082280208
10	36	44	300	5	082280210
12	41	53	500	5	082280212
16	54	74	800	1	082280216
19	66	86	1100	1	082280219

8240

eye bolts,
stainless steel AISI 316



LABORATORY TESTS

- chemical analysis
- tensile test

AVAILABLE CERTIFICATES

- Technical product specifications
- Test report UNI EN10204 type 2.2

A mm	B mm	ø C mm	WFL kg		
M6	41	15	75	10	082400206
M8	50	20	140	10	082400208
M10	62	25	230	5	082400210
M12	74	30	340	5	082400212

8242

eye nuts
stainless steel AISI 316



A mm	B mm	ø C mm	WFL kg		
M6	27	15	75	10	082420206
M8	36	20	140	10	082420208
M10	45	25	230	5	082420210
M12	55	30	340	5	082420212

8240F

lifting eye bolts, FORGED
stainless steel A4

CE



TECHNICAL DATA

- safety factor: 6

- traceability code

LABORATORY TESTS

- chemical analysis
- metallographic analysis
- tensile test

AVAILABLE CERTIFICATES

- Technical product specifications
- Test report UNI EN10204 type 2.2
- Inspection certificate UNI EN10204 type 3.1
- CE Declaration of Conformity

ø mm	WLL kg		
M6	1,0	120	4 082400406
* M8	1,25	200	4 082400408
* M10	1,5	400	4 082400410
* M12	1,75	600	4 082400412
* M14	2	1000	2 082400414
* M16	2	1200	2 082400416
* M20	2,5	2000	2 082400420
* M24	3	2700	2 082400424
* M30	3,5	4000	1 082400430

(* WLL increased compared to DIN standard according to Technical Specifications R/FT/8240F (guaranteed for stainless steel / stainless steel fits)

8242F

lifting eye nuts, FORGED
stainless steel A4

CE



TECHNICAL DATA

- safety factor: 6

- traceability code

LABORATORY TESTS

- chemical analysis
- metallographic analysis
- tensile test

AVAILABLE CERTIFICATES

- Technical product specifications
- Test report UNI EN10204 type 2.2
- Inspection certificate UNI EN10204 type 3.1
- CE Declaration of conformity

ø mm	WLL kg		
M6	1,0	120	4 082420406
* M8	1,25	200	4 082420408
* M10	1,5	400	4 082420410
* M12	1,75	600	4 082420412
* M14	2	1000	2 082420414
* M16	2	1200	2 082420416
* M20	2,5	2000	2 082420420
* M24	3	2700	2 082420424
* M30	3,5	4000	1 082420430

(* WLL ø M10÷M24

- increased according to Technical File R/FT/8242F
- guaranteed with stainless steel coupling

8248

eye tie rods,
stainless steel 316L,
right thread



UNI 6058

AVAILABLE CERTIFICATES

- Technical Product Specifications
- Test Report UNI EN10204 type 2.2

ØxL mm	F mm		
10x80	8	1	082480010
10x130	8	1	082480012
12x95	10	1	082480016
12x125	10	1	082480018

8249

fastening eyebolts, right thread
AISI 316



LABORATORY TESTS

- chemical analysis
- tensile test

AVAILABLE CERTIFICATES

- Technical product specifications
- Test report UNI EN10204 type 2.2

A	ØB	D	WFL		
mm	mm	mm	kg		
M5	11	50	100	10	082490205
M6	13	55	160	10	082490206
M8	17	60	300	5	082490208
M10	21	80	470	5	082490210
M12	25	120	690	1	082490212

8249G

fastening hooks
AISI 316

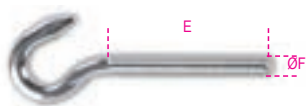

LABORATORY TESTS

- chemical analysis
- tensile test

AVAILABLE CERTIFICATES

- Technical Product Specifications
- Test Report UNI EN10204 type 2.2

A	E	ØF	WFL		
mm	mm	mm	kg		
M5	39	9	25	5	082490305
M6	43	10,5	45	5	082490306
M8	57	14,5	95	3	082490308

8250

spring snap-casting eye end
AISI 316



LABORATORY TESTS

- chemical analysis
- tensile test

AVAILABLE CERTIFICATES

- Technical product specifications
- Test report UNI EN10204 type 2.2

L	A	ØB	WFL		
mm	mm	mm	kg		
50	25	8	40	5	082500205
70	31	12,5	90	5	082500207
100	47	20	190	1	082500210

8264

swivel eye bolt snap
AISI 316



LABORATORY TESTS

- chemical analysis
- tensile test

AVAILABLE CERTIFICATES

- Technical product specifications
- Test report UNI EN10204 type 2.2

B	L	C	WFL		
mm	mm	mm	kg		
12	88	12	60	5	082640212
16	90	12	60	5	082640216
19	93	12	60	1	082640219

8267

swivel eye snap
AISI 316



LABORATORY TESTS

- chemical analysis
- tensile test

AVAILABLE CERTIFICATES

- Technical product specifications
- Test report UNI EN10204 type 2.2

A	L	B	WFL		
mm	mm	mm	kg		
10	87	21	30	5	082670210
12	118	22	70	1	082670213

8272

eye and eye swivels
AISI 316

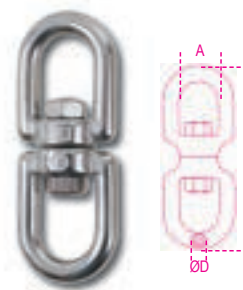

LABORATORY TESTS

- chemical analysis
- tensile test

AVAILABLE CERTIFICATES

- Technical product specifications
- Test report UNI EN10204 type 2.2

ØD	A	L	WFL		
mm	mm	mm	kg		
4	11	50	90	5	082720204
5	13	60	115	5	082720205
6	15	66	140	5	082720206
8	19	90	250	3	082720208
10	23	112	300	1	082720210
13	33	148	650	1	082720213
16	38	184	1000	1	082720216
19	40	223	1600	1	082720219

8273

quick-release hooks
with swivel eyes
AISI 316 stainless steel

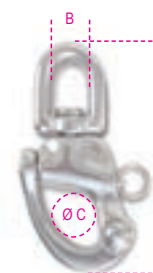

LABORATORY TESTS

- chemical analysis
- tensile test

AVAILABLE CERTIFICATES

- Technical product specifications
- Test report UNI EN10204 type 2.2

ØC x L	B	WFL	BF		
mm	mm	kg	kg		
12x70	12	230	1100	1	082730012
16x85	14,50	440	2000	1	082730016
22x120	20	700	3500	1	082730022

 **Robur**

8274

carabine hooks
AISI 316

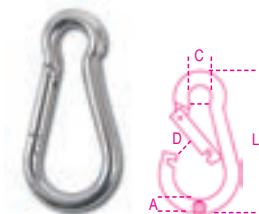

LABORATORY TESTS

- chemical analysis
- tensile test

AVAILABLE CERTIFICATES

- Technical product specifications
- Test report UNI EN10204 type 2.2

ø A x L	ø C	D	WFL		
mm	mm	mm	kg		
4,5x40	6,5	6	20	10	082740204
5x50	7	6,5	30	10	082740205
6x60	8,5	7,5	40	5	082740206
7x70	10	9	60	5	082740207
8x80	12	10	75	5	082740208
9x90	12,5	10,5	100	5	082740209
10x100	15	13	120	1	082740210
11x120	19	18	140	1	082740211
12x140	22	21	140	1	082740212
13x160	22	26	200	1	082740213

8274A

ring carabine hooks
AISI 316

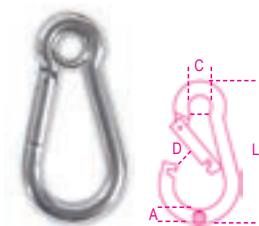

LABORATORY TESTS

- chemical analysis
- tensile test

AVAILABLE CERTIFICATES

- Technical Product Specifications
- Test Report UNI EN10204 type 2.2

ø A x L	ø C	D	WFL		
mm	mm	mm	kg		
5x50	6,5	7	30	10	082740405
6x60	7,5	7,5	40	5	082740406
8x80	9,5	10	75	5	082740408

8274G

carabine hooks with screw nut
AISI 316

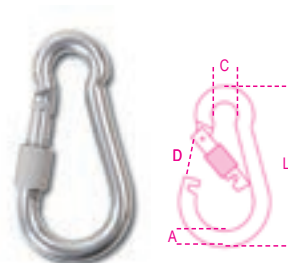

LABORATORY TESTS

- chemical analysis
- tensile test

AVAILABLE CERTIFICATES

- Technical product specifications
- Test report UNI EN10204 type 2.2

ø A x L	ø C	D	WFL		
mm	mm	mm	kg		
6x60	8,5	6,5	40	5	082740306
8x80	12	8,5	75	5	082740308
10x100	15	12	120	3	082740310

8276

asymmetric carabine hooks
AISI 316

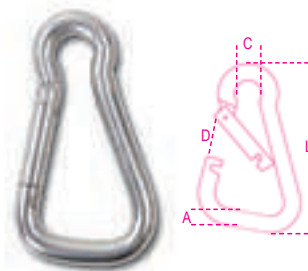

LABORATORY TESTS

- chemical analysis
- tensile test

AVAILABLE CERTIFICATES

- Technical product specifications
- Test report UNI EN10204 type 2.2

ø A x L	ø C	D	WFL		
mm	mm	mm	kg		
6x60	8,5	10	40	5	082760206
8x80	12	14	75	5	082760208
10x100	15	18	120	3	082760210

8276G

asymmetric carabine hooks with screw nut
AISI 316



LABORATORY TESTS

- chemical analysis
- tensile test

AVAILABLE CERTIFICATES

- Technical product specifications
- Test report UNI EN10204 type 2.2

ø A x L	ø C	D	WFL		
mm	mm	mm	kg		
6x60	8,5	9	40	3	082760306
8x80	12	12,5	75	3	082760308
10x100	15	16	120	3	082760310

8278

trapezoidal carabine hooks
AISI 316

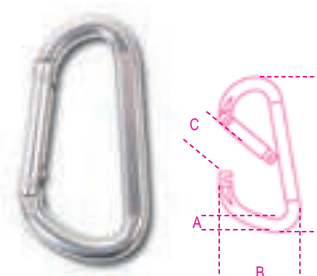

LABORATORY TESTS

- chemical analysis
- tensile test

AVAILABLE CERTIFICATES

- Technical product specifications
- Test report UNI EN10204 type 2.2

ø A x L	B	C	WFL		
mm	mm	mm	kg		
8x80	45	14	75	3	082780208
10x100	55	16	120	3	082780210

8280

quick links
AISI 316

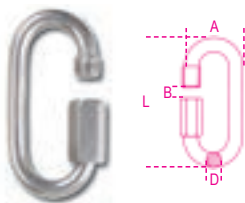

LABORATORY TESTS

- chemical analysis
- tensile test

AVAILABLE CERTIFICATES

- Technical product specifications
- Test report UNI EN10204 type 2.2

∅ D x L	A	B	WFL		
mm	mm	mm	kg		
3,5x35	17	5	20	10	082800203
4x40	19	6	30	10	082800204
5x50	23	7	50	5	082800205
6x60	26	8	60	5	082800206
7x70	30	9	100	5	082800207
8x80	33	10	140	1	082800208
10x90	40	12	220	1	082800210
12x100	47	14	300	1	082800212

8282

S-hooks
AISI 316

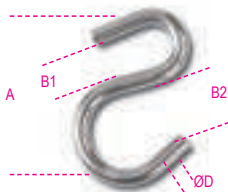

LABORATORY TESTS

- chemical analysis
- tensile test

AVAILABLE CERTIFICATES

- Technical product specifications
- Test report UNI EN10204 type 2.2

∅ D	B1	B2	WFL		
mm	mm	mm	kg		
3	7,5	14	4	10	082820203
4	10,5	14,5	5	10	082820204
5	12,5	16	12	10	082820205
6	12,5	18	18	5	082820206
8	14	23	33	5	082820208

8282S

S-hooks, symmetric
AISI 316 stainless steel

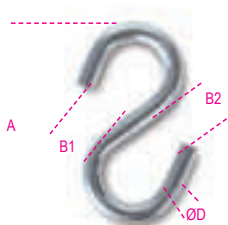

LABORATORY TESTS

- chemical analysis
- tensile test

AVAILABLE CERTIFICATES

- Product specifications
- Test report type 2.2 UNI EN10204

∅ D	A	B1	WFL		
mm	mm	mm	kg		
3	7,4	25	4	40	082820303
4	8,0	33	5	30	082820304
5	9,0	35	12	20	082820305
6	10,5	44	18	15	082820306

8284

pelican hooks terminals
AISI 316 stainless steel



LABORATORY TESTS

- chemical analysis
- tensile test

AVAILABLE CERTIFICATES

- Technical product specifications
- Test report UNI EN10204 type 2.2

∅ C	B	L	WFL		
mm	mm	mm	kg		
6	11	73	200	3	082840006
8	14	98	300	3	082840008
10	23	143	450	1	082840010

8285

jaw terminals
AISI 316

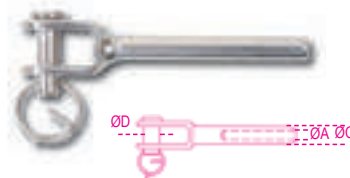

LABORATORY TESTS

- chemical analysis
- tensile test

AVAILABLE CERTIFICATES

- Technical product specifications
- Test report UNI EN10204 type 2.2

∅ A	∅ C	∅ D	WFL		
mm	mm	mm	kg		
3	6,3	6	180	5	082850203
4	7,5	6	200	3	082850204
5	9	10	330	1	082850205
6	12,5	12	720	1	082850206
8	16	13	1120	1	082850208

8286

eye terminals
AISI 316



LABORATORY TESTS

- chemical analysis
- tensile test

AVAILABLE CERTIFICATES

- Technical product specifications
- Test report UNI EN10204 type 2.2

∅ D	∅ A	∅ C	WFL		
mm	mm	mm	kg		
3	6,5	6,3	180	5	082860203
4	8,5	7,5	200	3	082860204
5	10,6	9	330	1	082860205
6	13	12,5	720	1	082860206
8	14,7	16	1120	1	082860208

8287

swage studs
AISI 316



LABORATORY TESTS

- chemical analysis
- tensile test

AVAILABLE CERTIFICATES

- Technical product specifications
- Test report UNI EN10204 type 2.2

∅ D	∅ A	E	WFL		
mm	mm	mm	kg		
3	6,3	M6	180	5	082870203
4	7,5	M8	200	3	082870204
5	9	M10	330	1	082870205
6	12,5	M12	720	1	082870206
8	16	M16	1120	1	082870208

8290

pad eyes
AISI 316



LABORATORY TESTS

- chemical analysis

AVAILABLE CERTIFICATES

- Technical product specifications
- Test report UNI EN10204 type 2.2

∅ A	B	∅ C	L		
mm	mm	mm	mm		
5	18	4,3	40	5	082900205
6	22	5,2	44	5	082900206
8	23	5,2	51	5	082900208

8381SX

U bolts for pipes

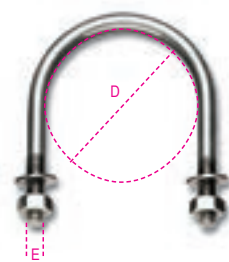

AISI 304

LABORATORY TESTS

- chemical analysis

AVAILABLE CERTIFICATES

- Test report UNIEN10204 type 2.2

D	D	E		
mm	gas	mm		
11	1/8"	M6	20	083810401
14	1/4"	M6	20	083810402
18	3/8"	M6	20	083810403
22	1/2"	M6	20	083810404
27	3/4"	M6	20	083810405
34	1"	M6	20	083810406
43	1 1/4"	M6	20	083810407
49	1 1/2"	M8	10	083810408
61	2"	M8	10	083810409
77	2 1/2"	M8	10	083810410
89	3"	M8	10	083810412
115	4"	M8	10	083810413
168	6"	M10	1	083810416
220	8"	M10	1	083810418

8293

ratchet tie downs AISI 304
high-tenacity polyester belt, LC 300 kg,
with hooks

hangable

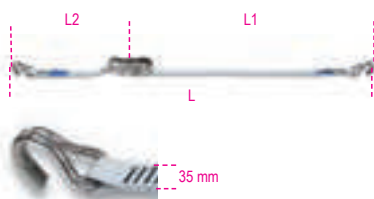

L	L2	L1	
m	mm	mm	
6	5700	300	1 082930106

LC = 300 kg

8297C

ratchet tie downs,
with mini-ratchets, AISI 304
high-tenacity polyester belt, LC 700 kg

hangable

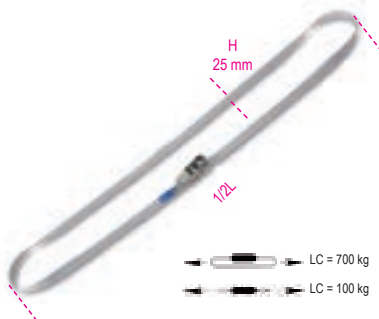

L	H	
m	mm	
5	25	1 082970350

8297F

2 cam buckle straps,
AISI 304,
high-tenacity polyester belt, LC 250 kg

hangable

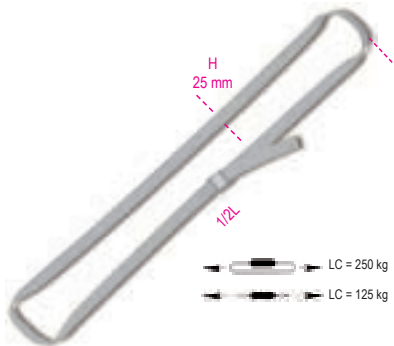

L	H	
m	mm	
3	25	1 082970230

LC = 250 kg

**Special packaging for
your free-service sales
+ CE declaration of
conformity
+ instruction for use**



8001Z-K

CE



Ø			
mm			
M5	2	1	080019305
M6	2	1	080019306
M8	1	1	080019108
M10	1	1	080019110
M11	1	1	080019111
M12	1	1	080019112
M14	1	1	080019114
M16	1	1	080019116
M18	1	1	080019118
M20	1	1	080019120
M22	1	1	080019122
M24	1	1	080019124

8001TZ-K

CE



Ø			
mm			
M12	1	1	080019512
M16	1	1	080019516
M20	1	1	080019520
M24	1	1	080019524

8005Z-K

CE



Ø			
mm			
M5	2	1	080059305
M6	2	1	080059306
M8	1	1	080059108
M10	1	1	080059110
M11	1	1	080059111
M12	1	1	080059112
M14	1	1	080059114
M16	1	1	080059116

8005TZ-K

CE



Ø			
mm			
M12	1	1	080059512

8006Z-K

CE



Ø			
mm			
M5	2	1	080069305
M6	2	1	080069306
M8	1	1	080069108
M10	1	1	080069110
M11	1	1	080069111
M12	1	1	080069112
M14	1	1	080069114

8007Z-K

CE



Ø			
mm			
M5	2	1	080079305
M6	2	1	080079306
M8	1	1	080079108
M10	1	1	080079110
M11	1	1	080079111
M12	1	1	080079112

8008N-K



Ø mm	Hand	Box	Carton	Code
M5	2	1	1	080089305
M6	2	1	1	080089306
M8	1	1	1	080089208
M10	1	1	1	080089210
M12	1	1	1	080089212
M14	1	1	1	080089214

8009Z-K



Ø mm	Hand	Box	Carton	Code
M8	1	1	1	080099008
M10	1	1	1	080099010
M12	1	1	1	080099012

8009TZ-K



Ø mm	Hand	Box	Carton	Code
M12	1	1	1	080099512

8010Z-K



Ø mm	Hand	Box	Carton	Code
M8	1	1	1	080109008
M10	1	1	1	080109010
M12	1	1	1	080109012
M14	1	1	1	080109014

8105-K



ØxE"	Hand	Box	Carton	Code
3/8x6	1	1	1	081059010
1/2x9	1	1	1	081059012

Robur

8109-K



ØxE"	Hand	Box	Carton	Code
3/8x6	1	1	1	081099010
1/2x9	1	1	1	081099012

8016-K



Ø mm	Hand	Box	Carton	Code
3	6	1	1	080169403
5	4	1	1	080169405
6	4	1	1	080169406
8	4	1	1	080169408
10	2	1	1	080169410
11	1	1	1	080169011
12-13	1	1	1	080169013
14	1	1	1	080169014
16	1	1	1	080169016
18	1	1	1	080169018
20	1	1	1	080169020
22	1	1	1	080169022
24-26	1	1	1	080169026

8016FR-K



Ø mm	Hand	Box	Carton	Code
3	6	1	1	080169753
5	6	1	1	080169755
6	4	1	1	080169756
8	4	1	1	080169758

8016U-K



Ø mm	Hand	Box	Carton	Code
5	4	1	1	080169805
6	4	1	1	080169806
8	4	1	1	080169808
10	2	1	1	080169810
12	1	1	1	080169612
14	1	1	1	080169614
16	1	1	1	080169616
19	1	1	1	080169619
22	1	1	1	080169622
26	1	1	1	080169626

8025-K



Ø mm	Hand	Box	Carton	Code
5	4	1	1	080259205
6	4	1	1	080259206
8	2	1	1	080259208
10	2	1	1	080259210
11	1	1	1	080259011
12	1	1	1	080259012
14	1	1	1	080259014
16	1	1	1	080259016
18	1	1	1	080259018
20	1	1	1	080259020
22	1	1	1	080259022
25	1	1	1	080259025

8026A-K



Ø mm	Hand	Box	Carton	Code
12	1	1	1	080269012
14	1	1	1	080269014
16	1	1	1	080269016
18	1	1	1	080269018
20	1	1	1	080269020
22	1	1	1	080269022
25	1	1	1	080269025

8026R-K



ØA mm	Hand	Box	Carton	Code
13	1	1	1	080269212
16	1	1	1	080269216

8028-K



Ø mm	Hand	Box	Carton	Code
5	4	1	1	080289305
6	4	1	1	080289306
8	2	1	1	080289308
10	2	1	1	080289310
12	1	1	1	080289112
14	1	1	1	080289114
16	1	1	1	080289116
18	1	1	1	080289118
20	1	1	1	080289120
22	1	1	1	080289122

Robur

8029R-K

CE



ØA mm			
6	1	1	080299106
8	1	1	080299108
10	1	1	080299110
11	1	1	080299111
13	1	1	080299112
16	1	1	080299116

8031R-K

CE



ØA mm			
13	1	1	080319112
16	1	1	080319116

8032-K

CE



ØA mm			
13	1	1	080329012
16	1	1	080329016

8040EN-K

CE



Ø mm			
M6	4	1	080409506
M8	4	1	080409508
M10	2	1	080409510
M12	1	1	080409312
* M14	1	1	080409314
M16	1	1	080409316
* M18	1	1	080409318
M20	1	1	080409320
* M22	1	1	080409322
M24	1	1	080409324
* M27	1	1	080409327
M30	1	1	080409330

Robur

8040EZ-K

CE



Ø mm			
M6	4	1	080409606
M8	4	1	080409608
M10	2	1	080409610
M12	1	1	080409412
* M14	1	1	080409414
M16	1	1	080409416
* M18	1	1	080409418
M20	1	1	080409420
* M22	1	1	080409422
M24	1	1	080409424
* M27	1	1	080409427
M30	1	1	080409430

8041-K

CE



Ø mm			
* M8	1	1	080419208
* M10	1	1	080419210
* M12	1	1	080419212

8042EN-K

CE



Ø mm			
M6	4	1	080429506
M8	4	1	080429508
M10	2	1	080429510
M12	1	1	080429312
* M14	1	1	080429314
M16	1	1	080429316
* M18	1	1	080429318
M20	1	1	080429320
* M22	1	1	080429322
M24	1	1	080429324
* M27	1	1	080429327
M30	1	1	080429330

8042EZ-K

CE



Ø mm			
M6	4	1	080429606
M8	4	1	080429608
M10	2	1	080429610
M12	1	1	080429412
* M14	1	1	080429414
M16	1	1	080429416
* M18	1	1	080429418
M20	1	1	080429420
* M22	1	1	080429422
M24	1	1	080429424
* M27	1	1	080429427
M30	1	1	080429430

8043-K

CE



Ø mm			
* M8	1	1	080439208
* M10	1	1	080439210
* M12	1	1	080439212

8051S-K

CE



WLL kg			
250	1	1	080519202
500	1	1	080519205

8216-K

CE



Ø F mm			
2	4	1	082169402
3	4	1	082169403
4	4	1	082169404
5	2	1	082169405
6	2	1	082169406
8	2	1	082169408
10	2	1	082169410

Robur

Robur



Beta *Collection*

A range of exclusive products designed and developed to epitomize Beta's character, it comprises over 200 original, first-rate items: sports equipment, technical clothing and a variety of tailored objects. An ideal medium for promotional actions, a must for recreational moments.

9500TL

softshell jacket, made of 100% polyester, 320 g/m2, three-layered, microfibre outer shell, waterproof, breathable intermediate membrane, fleece interior



S	1	095000051
M	1	095000052
L	1	095000053
XL	1	095000054
XXL	1	095000055

9501TL

sweatshirt, made of cotton (80%), and polyester (20%), 320 g/m2



S	1	095010051
M	1	095010052
L	1	095010053
XL	1	095010054
XXL	1	095010055

9502TL

polo shirt, 100% pique cotton, 210 g/m2



S	1	095020051
M	1	095020052
L	1	095020053
XL	1	095020054
XXL	1	095020055

9503TL

t-shirt, 100% jersey cotton, 160 g/m2



S	1	095030051
M	1	095030052
L	1	095030053
XL	1	095030054
XXL	1	095030055

9504TL

jacket with 100% polyester exterior, waterproof treatment



S	1	095040051
M	1	095040052
L	1	095040053
XL	1	095040054
XXL	1	095040055

9505TL

sleeveless jacket with 100% polyester exterior, waterproof treatment, padding 100 g/m2, interior pocket



S	1	095050051
M	1	095050052
L	1	095050053
XL	1	095050054
XXL	1	095050055

9572MB

Beta-March F1 vintage T-shirt, 100% cotton



S	1	095720701
M	1	095720702
L	1	095720703
XL	1	095720704
XXL	1	095720705

9507U

men's sweatshirt, made of CVC fleece fabric, 60% cotton and 40% polyester, with hood and long zip



M	1	095070052
L	1	095070053
XL	1	095070054
XXL	1	095070055

9507D

women's sweatshirt, made of CVC fleece fabric, 60% cotton and 40% polyester, with hood and long zip



S	1	095070061
M	1	095070062
L	1	095070063
XL	1	095070064

9508TL

waterproof jacket, 100% polyester, folds into pocket



S	1	095080051
M	1	095080052
L	1	095080053
XL	1	095080054
XXL	1	095080055

9510

short-sleeved shirt, 100% poplin cotton, 110 g/m², orange fabric inserts and white piping trim, contrasting orange button, reflective heart-side logo and back print



XS	1	095100000
S	1	095100001
M	1	095100002
L	1	095100003
XL	1	095100004
XXL	1	095100005

9533N

polyester shirt, breathable, 175 g/m², black



S	1	095330051
M	1	095330052
L	1	095330053
XL	1	095330054
XXL	1	095330055

9534W

three-button polo shirt, carded pique cotton 220 g/m², white



S	1	095340011
M	1	095340012
L	1	095340013
XL	1	095340014
XXL	1	095340015

9534B

three-button polo shirt, carded pique cotton 200 g/m², blue



S	1	095340051
M	1	095340052
L	1	095340053
XL	1	095340054
XXL	1	095340055

9537N

fleece pullover, black, 100% polyester



M	1	095370102
L	1	095370103
XL	1	095370104
XXL	1	095370105

9580S

sunglasses "Summer" style

CE



EN ISO 12312-1:2013+A1:2015
UV400
FILTER CAT. III

9580S	1	095800100
-------	---	-----------

9593M

automatic watch, steel case, 5 ATM water resistant, steel wristband



9593M	1	095930120
-------	---	-----------

9593A

chronograph, steel case, 5 ATM water resistant, silicone strap



9593A	1	095930050
-------	---	-----------

9593W

analogue watch, soft touch plastic case with metal ring, 3 ATM water resistant, silicone strap



9593W	1	095930150
-------	---	-----------

9544C

cabin-size trolley with 4 double wheels, TSA lock, USB port + 3.5-mm jack



9544C 1 095440101

9557J 2.0

bag made of coated polyester/Oxford 600D polyester fabric, dimensions 47x28x25 cm



9557J 2.0 1 095570020

9557J 3.0

bag made of coated polyester/Oxford 600D, dimensions 58x29x36 cm



9557J 3.0 1 095570030

9557N

"Racing" bag, made from waterproof PVC coated fabric



cm 80x35x35 1 095570001

9541F

rucksack made of coated polyester/Oxford 600D polyester fabric, dimensions 50x33x16 cm



9541F 1 095410011

9541S

Rucksack with casing, made of waterproof 210D polyester, 33x45 cm



9541S 1 095410031

9541BIKE

rucksack made of Oxford polyester, dimensions 41x24x16 cm



9541BIKE 1 095410021

95740

work gloves, with stretch-elastic cuffs, reinforced thumbs and index fingers, made from touchscreen capable synthetic leather



M 1 095740202
L 1 095740203
XL 1 095740204
XXL 1 095740205

9574B

work gloves, with stretch-elastic cuffs, reinforced thumbs and index fingers, made from touchscreen capable synthetic leather



M 1 095740102
L 1 095740103
XL 1 095740104
XXL 1 095740105

9525TL

Top Line cap



9525TL 1 095250010

9525BB

bike cap



9525BB 1 095250020



9525/N

cap, 100% cotton, one-size-fits-all adjustable buckle strap, directly embroidered front, sides and back, black



9525N 5 095251021

9525/B

cap, 100% cotton, one size-fits-all adjustable buckle strap, directly embroidered front, sides and back, white



9525B 5 095251031

9521

umbrella, nylon T210, 3-section aluminium frame, automatic open/close mechanism



9521 1 095210000

95210B

umbrella made of nylon 210T, diameter 120 cm



95210B 1 095210021

9599CB

Atala® city bike, 49 cm aluminium frame, Shimano® 6 speed gear, V-brake®, 28" aluminium rims



9599CB 1 095990011

9599CB-W

Atala® city bike, aluminium frame, Shimano® 6-speed gear, V-Brakes® 28" aluminium rims



9599CB-W 1 095990023

9598W

Whistle® mountain bike, aluminium frame, Suntour XCT fork, Shimano Acera 7 speed gear (14-28), disc brakes and 29" aluminium rims



9598W M 1 095980110
9598W L 1 095980112

9598WHP

Whistle® mountain bike, aluminium frame, Suntour XCM remote lockout fork, Shimano Deore XT 12 speed gear, hydraulic Shimano brakes and 29" aluminium rims



9598WHP M 1 095980120
9598WHP L 1 095980122

9515M

technical jersey, made from quick-dry, breathable fabric; side mesh inserts



S	1 095150051
M	1 095150052
L	1 095150053
XL	1 095150054
XXL	1 095150055
XXXL	1 095150056

9516B

shorts made from quick-dry, breathable Lycra, 180 g/m2, with elastic waistband for improved fit



S	1 095160051
M	1 095160052
L	1 095160053
XL	1 095160054
XXL	1 095160055
XXXL	1 095160056

9539CB

protective road and mountain bike cycling helmet with detachable chin guard - adjustable sizes



S-M	1 095390010
L-XL	1 095390011

Beta

9542M

short-sleeved jersey, breathable microfibre fabric, long, covered zip, three rear pockets, including one with zip, silicone elastic at jersey end



Size	Quantity	SKU
S	1	095420051
M	1	095420052
L	1	095420053
XL	1	095420054
XXL	1	095420055
XXXL	1	095420056

9542C

Lycra bib shorts, silicone elastic at leg end, antibacterial seat padding



Size	Quantity	SKU
S	1	095420061
M	1	095420062
L	1	095420063
XL	1	095420064
XXL	1	095420065
XXXL	1	095420066

Beta

9542GW

winter jacket, made from highly breathable, winder breaker fabric and raised fabric; long zip, silicone-free elastic waistband; close-fitting Lycra cuffs; refractive rear inserts; 3 exterior rear pockets, including 1 with zip



Size	Quantity	SKU
S	1	095420101
M	1	095420102
L	1	095420103
XL	1	095420104
XXL	1	095420105
XXXL	1	095420106

9542G

winter jersey, breathable fabric, raised inside, long zip, three rear pockets, silicone elastic at jersey end



Size	Quantity	SKU
S	1	095420012
M	1	095420013
L	1	095420014
XL	1	095420015
XXL	1	095420016
XXXL	1	095420017

9542S

winter underpants, raised Lycra, antibacterial, high-breathability seat padding



Size	Quantity	SKU
S	1	095420022
M	1	095420023
L	1	095420024
XL	1	095420025
XXL	1	095420026
XXXL	1	095420027

9542AT

sleeveless wind stopper jacket, breathable bound fabric, long zip



Size	Quantity	SKU
S	1	095420072
M	1	095420073
L	1	095420074
XL	1	095420075
XXL	1	095420076
XXXL	1	095420077

Beta

Beta

9542AL

waterproof windbreaker, long-sleeved, made of breathable fabric



S	1	095420042
M	1	095420043
L	1	095420044
XL	1	095420045
XXL	1	095420046
XXXL	1	095420047

9597P

column pump with gauge



9597P	1	095970100
-------	---	-----------

9524SC

miniature Beta garage for collectors



1:18	1	095240018
------	---	-----------

9548KB

balance bike, aluminium frame, 12" wheel with inner tube; recommended for children from 3 years; maximum weight: 30 kg



9548KB	1	095480110
--------	---	-----------

9547WSK

"Kinder Work Station", workbench with tools, for children from 3 years of age



9547WSK	1	095473801
---------	---	-----------

9547T

"Kinder trolley", tool trolley, for children from 3 years of age, complete with tools



9547T	1	095470100
-------	---	-----------

9548G

"Kinder Garage", 6-storey, with car wash, lift and ramps



9548G	1	095480100
-------	---	-----------

9561VV

sail flag banner, 4x0.75 m



9561VV	1	095610101
--------	---	-----------

9561V

sail flag, 4x0.75 m, with chrome-plated metal pole, grit concrete base, 50 cm



9561V	1	095610001
-------	---	-----------

9559

one-sided banner, TNT; modules: 3x0.8 m



9559	1	095591001
------	---	-----------

9559/30MT

nonwoven fabric roll of 10 Beta logos



9559/30MT	1	095591031
-----------	---	-----------

9590B

flag, made of screen-printed nylon



9590B	1	095900000
-------	---	-----------

9582LE

luminous sign, one-sided, for outdoor use



9582LE	1	095820010
--------	---	-----------

9577M

overalls, T/C twill, polyester/cotton (65/35), 240 g/m2



SIZE	QTY	SKU
S	1	095770051
M	1	095770052
L	1	095770053
XL	1	095770054
XXL	1	095770055
XXXL	1	095770056

9579C

work jacket, polyester/cotton



SIZE	QTY	SKU
M	1	095791002
L	1	095791003
XL	1	095791004

9563G

office armchairs, for guests



9563G 1 095630050

9563P

office armchair, black



9563P 1 095630010

9549PB

portable battery, ultrathin, 5400 mA



9549PB 1 095490051

9549USB

USB key, 8 GB



9549USB 1 095490061

9547

desk calculator



9547 1 095470000

9594

clock complete with thermometer and hygrometer, 26 cm in diameter



Ø 26 cm 1 095940051

9526P

capsule espresso coffee machine. (capsules not included) Compatible with Lavazza™ and Espresso Point™ capsules for professional use



9526P 1 095260010

9527 6T

set of 6 coffee cups



9527 6T 1 095270001



9527MUG

cup with cover and silicone sleeve



9527MUG

1 095270020

9526RMN

set of 2 packs of 55 rummy playing cards by Modiano®



9526RMN

1 095260001

9586K

multipurpose steel knife, 10 functions



9586K

1 095860100

9592B/C50

set of 50 pens



9592B/C50

1 095920050

9592B/P

customised pens



9592B/P

500 095920051

9592MB

Parker® ballpoint pen



9592MB

1 095920060

9592M/50

set of 50 pencils



9592M/50

1 095920100

9588M

soft foam tray with 1 pen and 2 notebooks



9588M

1 095880011

9596

badge holder, polyester, with metal clip and mobile phone string



9596

10 095961001

9595C

leather key ring



9595C

1 095950011

9595T

metal chrome-plated key ring, in velvet pouch



9595T

1 095950021

9595 C25

metal chrome-plated key ring with rubber hook



9595 C25

1 095950031

9569P

shopper, made of polyethylene, folded sides



9569P

44x34

50 095691001

9569S

TNT shopper with folded sides, 38x42 cm



9569S

50 095690051

9569MS

shopper, made of hard-wearing polypropylene



9569MS

5 095690052

9587 9x14

notebook, 9x14 cm



9587 9X14

5 095870009

9587 13x21

notebook, 13x21 cm



9587 13X21

5 095870013

9588S/10...

set of 10 notepads



9588S/10A
21x29 cm

1 095881001

9588S/10B
15x21 cm

1 095881002

9588S/10C
10x15 cm

1 095881003

9588S/10D
7,5x10,5 cm

1 095880054

9588/10PI

set of 10 notepads with adhesive sheets



9588S/10PI
7,5x7,5 cm

1 095880055

9589A/36

pack of 36 rolls of packaging adhesive tape, with Beta logo, tawny



9589A/36

1 095890035

9589B/36

pack of 36 rolls of packaging adhesive tape, with Beta logo, white



9589B/36

1 095890036

9562TB

mat for trying on shoes, with anti-skid, rubber-coated bottom



9562TB

1 095620500

9562T2

workbench mat, 200x160 cm

- protects floor from oil and petrol leaks, environmentally friendly
- easy to clean, anti-skid, rubber-coated bottom

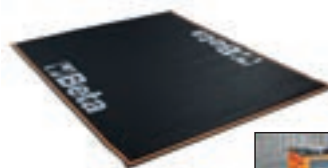

9562T2

1 095620200

Beta

9562T3

garage mat

Dimensions: 300x160 cm

- particularly suitable for use under motorcycle jacks
- protects floor from oil and petrol leaks, environmentally friendly
- easy to clean, anti-skid, rubber-coated bottom



9562T3

1 095620300

9562P2

multilogo mat, 200x80 cm

- particularly suitable for use with workshop equipment item C55 or under motorcycles



9562P2

1 095620400

9562P25

multilogo mat roll, 25 m x 80 cm

Allows mat length to be customized as needed



9562P25

1 095620425

Beta



FIELDS OF USE FOR TORQUE WRENCHES

1 Nm = 0,10197 Kgfm = 0,7375 lbf.ft



Size	Model	Image	Scale	Min (Nm)	Max (Nm)
1/4"	590		0,3	4	
	590/1		0,5	13,5	
	603/5		1	5	
	603/10		2	10	
	605E/5		1	5	
	605E/10		2	10	
	666N/2			5	25
3/8"	592/3		1	27	
	592/4			3	40
	599DGT/6			12	60
	665/6			10	60
	665/10			20	100
	665LB/6			7 LBF.FT	45 LBF.FT
	665LB/10			15 LBF.FT	75 LBF.FT
	666N/2X			5	25
	666N/5			10	50
	666N/10			20	100
	666N LBF.IN/5			90 LBF.IN	440 LBF.IN
	666N LBF.IN/10			200 LBF.IN	800 LBF.IN
	1/2"	594/8			6
594/21				20	215
599DGT/10X				20	100
599DGT/20				40	200
599DGT/30				68	340
599DGT-AN/10				20	100
599DGT-AN/20				40	200
606MQ/50				5	50
665/10X				20	100
665/20				40	200
665/30				60	330
665LB/10X				15 LBF.FT	75 LBF.FT
665LB/20				30 LBF.FT	150 LBF.FT
665LB/30				45 LBF.FT	240 LBF.FT
666N/10X				20	100
666N/20				40	200
666N/30				60	300
666N LBF.IN/10X				200 LBF.IN	800 LBF.IN
666N LBF.IN/20				400 LBF.IN	1800 LBF.IN
666N LBF.IN/30				500 LBF.IN	3000 LBF.IN
667N/20				40	200
667N/30			60	300	
3/4"	596/40SL			80	400
	596/80SL			160	800
	667N/40			80	400
	677/50 677C/50			100	500



ELIMINATED ITEMS – SUBSTITUTE/RECOMMENDED ITEMS

	ELIMINATED ITEM
	SUBSTITUTE ITEM
	RECOMMENDED ITEM

1055	010550024	1055	010550027
1058 180	010580018	1058 175	010580017
1058 240	010580024	1058 225	010580025
1058 310	010580031	1058 225	010580025
1061 290	010610028	1061 275	010610027
1062 460	010620046	1062 460	010620045
1062GM 460	010620246	1062GM 460	010620245
1062AL 290	010620329	1062AL 275	010620327
1063	010630020	1063	010630021
1064	010640024	1064	010640023
1128BMX	011280050	1128BMX	011280051
1128BSX	011280060	1128BSX	011280061
1130BMX	011300001	1130BMX	011300002
1461/C10A	014610101		
1476	014760001	1476	014760002
1476RC	014760010		
1491C	014910030	1491A	014910040
1493/T	014930075	1493H	014930077
1602/C9T	016020013	1602/C9	016020045
1604/C9T	016040013	1604/C9	016040045
1606A/C9	016060100	1606A/C9	016060045
1608/C9T	016080013	1608/C9	016080045
1610R/4K	016100104	BM00119	BM00119
1610R/5K	016100105	BM00125	BM00125
1610B/5K	016100115	BM00225	BM00225
1610B/6K	016100116	BM00231	BM00231
1610B/8K	016100118	BM00237	BM00237
1610G/6K	016100126	BM00331	BM00331
1610G/8K	016100128	BM00337	BM00337
1614R/1,9K	016140101	BM00151	BM00151
1614B/1,9K	016140102	BM00251	BM00251
1614G/2,8K	016140103	BM00350	BM00350
1616R/4K	016160104	BM00130	BM00130
1618R/4K	016180104	BM00140	BM00140
1620R/6,3K	016200101	BM00180	BM00180
1620B/6,3K	016200102	BM00280	BM00280
1620G/6,3K	016200103	BM00380	BM00380
1622R/2,8K	016220101	BM00395	BM00395
1622R/6,3K	016220103	BM00190	BM00190
1622B/6,3K	016220106	BM00290	BM00290
1622G/6,3K	016220108	BM00391	BM00391
1624R/6,3K	016240102	BM00191	BM00191
1624B/6,3K	016240104	BM00291	BM00291
1624G/6,3K	016240105	BM00392	BM00392
1628R/1,6K	016280101	BM00160	BM00160
1628B/2,3K	016280102	BM00260	BM00260
1628G/3,6K	016280103	BM00360	BM00360
1630R/K	016300101	BM00110	BM00110
1630B/K	016300102	BM00210	BM00210
1632W/0,5K	016320005	BM00601	BM00601
1632G/0,75K	016320007	BM00602	BM00602
1632R/1K	016320010	BM00603	BM00603
1632N/1,5K	016320015	BM00604	BM00604
1632B/2,5K	016320025	BM00506	BM00506
1632G/4K	016320040	BM00508	BM00508
1632Y/6K	016320060	BM00610	BM00610
1634W/0,5K	016340005	BM00651	BM00651
1634G/0,75K	016340007	BM00652	BM00652
1634R/1K	016340010	BM00654	BM00654
1634N/1,5K	016340015	BM00656	BM00656
1634B/2,5K	016340025	BM00558	BM00558
1634G/4K	016340040	BM00560	BM00560
1634Y/6K	016340060	BM00661	BM00661
1639NS-N	016390025	BMES-B1925NE	BMES-B1925NE

1748/3K	017480203	BMN1025	BMN1025
1748/6K	017480206	BMN1625	BMN1625
1748/7K	017480207	BMN1436	BMN1436
1748/8K	017480208	BMN2036	BMN2036
1748/9K	017480209	BMN2936	BMN2936
1748/14K	017480214	BMN1948	BMN1948
1748/17K	017480217	BMN3048	BMN3048
1748/18K	017480218	BMN3748	BMN3748
1748/23K	017480223	BMN2976	BMN2976
1748/24K	017480224	BMN3776	BMN3776
1748B/3K	017480303	BMB1025	BMB1025
1748B/6K	017480306	BMB1625	BMB1625
1748B/7K	017480307	BMB1436	BMB1436
1748B/8K	017480308	BMB2036	BMB2036
1748B/9K	017480309	BMB2936	BMB2936
1748B/14K	017480314	BMB1948	BMB1948
1748B/17K	017480317	BMB3048	BMB3048
1748B/18K	017480318	BMB3748	BMB3748
1760/IR800	017600380	1760/IR1000	017600400
1760/IR1600	017600460	1760/IR1600	017600461
1838LED/120	018380250		
1838LED/120-AL	018380251		
1927A	019270002	1927B	019270022
1930NCD	019300007	1930LH	019300030
1936/5	019360005	1936/5A	019360025
2001/B26	020010050	2001/B26	020010060
2009ID	020090012	2009ID	020090013
2028EL/A	020280114	2028EL/A	020280014
2028ET/A	020280118	2028ET/A	020280018
2029EL/B	020290217	2029EL/B	020290017
2029ET/B	020290221	2029ET/B	020290021
2032TEL/A	020320214	2032TEL/A	020320314
2032TET/A	020320228	2032TET/A	020320328
2033PEL/A	020330114	2033PEL/A	020330214
2033PEL/B	020330115	2033PEL/B	020330215
2033PET/B	020330127	2033PET/B	020330227
2036EL/B	020360118	2036EL/B	020360218
2036TET/B	020360123	2036TET/B	020360223
2041UC	020410200	2041UC	020410210
2051N	020510200	2051N	020510210
2055HB	020550210	2055HB	020550220
2104VU/0	021040121	2104VU/0	021040122
2105VU0	021050121	2105VU0	021050122
2106T/VU0	021060101	2106T/VU0	021060123
2107VU/2	021070102	2107VU/2	021070112
2107VU/3	021070104	2107VU/3	021070114
2108VU/1	021080021	2108VU/1	021080022
2109VU/1	021090021	2109VU/1	021090022
2109VU/3	021090124	2109VU/3	021090024
2110VU/1	021100021	2110VU/1	021100031
2110VU/3	021100024	2110VU/3	021100034
2110VU/AS	021100026	2110VU/AS	021100036
2110SVU/1	021100101	2110SVU/1	021100041
2110SVU/3	021100104	2110SVU/3	021100044
2111VU/1	021110101	2111VU/1	021110031
2111VU/3	021110104	2111VU/3	021110034
2112ET/A	021120128	2112ET/A	021120028
2112ET/B	021120129	2112ET/B	021120029
2112VU/5	021120156	2112VU/5	021120056
2114VU/M	021140009	2114VU/M	021140011
2115PVU/1	021150231	2115PVU/1	021150232
2115PVU/2	021150233	2115PVU/2	021150234
2115PL-VU/1	021150241	2115PL-VU/1	021150242
2115PL-VU/3	021150244	2115PL-VU/3	021150245
2116VU/1	021160101	2116VU/1	021160102
2116VU/3	021160104	2116VU/3	021160105
2117P-VU/1	021170041	2117P-VU/1	021170042
2117P-VU/3	021170044	2117P-VU/3	021170045
2117L-VU/1	021170141	2117L-VU/1	021170142
2117PL-VU/3	021170144	2117PL-VU/3	021170145

2118VU/1	021180031	2118VU/1	021180032
2119VU/3	021190024	2119VU/3	021190025
2119L-VU/3	021190124	2119L-VU/3	021190125
2120VU/2	021200016	2120VU/2	021200061
2120VU/4	021200018	2120VU/4	021200064
2120VU/AS	021200021	2120VU/AS	021200068
2120VU/3	021200028	2120VU/3	021200063
2120L-VU/2	021200116	2120L-VU/2	021200161
2120L-VU/4	021200118	2120L-VU/4	021200164
2120L-VU/AS	021200121	2120L-VU/AS	021200168
2120L-VU/3	021200128	2120L-VU/3	021200163
T288	024240288	T284	024240284
M160	024500160	M161	024500161
M288	024500288	M284	024500284
M300	024500300	M305	024500305
M77	024500876	M78	024500878
MB55	024504255	MB58	024504258
MB62	024504262	MB64	024504264
3040	030400001	3040C	030400002
3040A/1	030400501	3040C/S1	030400503
3040A/2	030400502	3040C/S2	030400504
3040A/6	030400506		
3040A/8	030400508		
3040A/10	030400510		
3041	030410001	3041C	030410002
3041T	030410011		
3041A/11	030410511	3041C/12	030410512
3041A/15	030410515	3041C/16	030410516
3041T/17	030410517		
3042	030420001	3042C	030420002
3042/K6P	030420101		
3043	030430001	3043C	030430002
3043A/41	030430541	3043C/41	030430551
3043A/42	030430542	3043C/42	030430552
3043A/43	030430543	3043C/43	030430553
3043A/44	030430544	3043C/44	030430554
3043A/45	030430545	3043C/45	030430555
3043A/46	030430546		
3043A/47	030430547	3043C/47	030430557
3043A/48	030430548		
3044	030440001		
3044A/41	030440541		
3047	030470001	3047C	030470002
3048	030480001	3048C	030480002
3050/C	030500011	3050/CC	030500012
3050/CL	030500021		
3050/M	030500031	3050/MS	030500032
3050/K-O	030500101	3050/O	030500201
3050/K-G	030500102	3050/G	030500202
3050/K-R	030500103	3050/R	030500203
3050/K2-O	030500121		
3050/K2-G	030500122		
3050/K2-R	030500123		
3051/LA	030510061		
3053	030530001		
3053/E	030530002		
3055	030550001	3055M	030550002
3063/2,5T	030630125		
3070	030700000	3070B	030700100
3070/1	030700001		
3070/2	030700002		
3070/3	030700003		
3070/4	030700004		
3072	030720001		
C33/6-O	033000261		

ELIMINATED ITEMS – SUBSTITUTE/RECOMMENDED ITEMS

	ELIMINATED ITEM
	SUBSTITUTE ITEM
	RECOMMENDED ITEM

C33/8-O	033000281	C37/8-O	037000081
C33/8-G	033000282	C37/8-G	037000082
C33/8-R	033000283	C37/8-R	037000083
C33PF	033000906		
C53	053000001	C54S-O	054000301
C53VI	053000090	C54S-G	054000302
C53VG	053000095	C54S-R	054000303
C54 O	054000001	C54S-O	054000301
C54 G	054000002	C54S-G	054000302
C54 R	054000003	C54S-R	054000303
C54VI-O	054000090	C54S-O	054000301
C54VI-G	054000092	C54S-G	054000302
C54VI-R	054000093	C54S-R	054000303
C54VG-O	054000095	C54S-O	054000301
C54VG-G	054000097	C54S-G	054000302
C54VG-R	054000098	C54S-R	054000303
C55B/GD	055000104		
C55B/GS	055000105		
C55B/GDE	055000154		
C55B/GSAA	055000156		
C55B/GSEA	055000165		
C55B/GDAA	055000166		
C55AN-O	055000181		
C55AN-O/PC	055000182		
C55AN-G	055000183		
C55AN-G/PC	055000184		
C55AN/PS	055000191		
C55RB/AN	055000197		
C55/3PM	055000300		
C55/3PF	055000308		
C55/2PF	055000310		
C55PP-O	055000350		
C55PP-G	055000355		
5902MT	059020043	5902MT	059020053
5902MT/AS	059020044	5902MT/AS	059020054
5902VI	059020050	5902VI	059020060
5904VG/3	059040192	5904VG/3	059040062
5904VU/2T	059040520	5904VU/2T	059040070
5905VG/2	059050144	5905VG/2	059050044
5905VG/1	059050158	5905VG/1	059050058
5908VG/2T	059080117	5908VG/2T	059080017
5910VI/3	059100054	5910VI/3	059100044
5914VU/M	059140109	5914VU/M	059140111
5915VU/0	059150121	5915VU/0	059150021
5915VU/1	059150124	5915VU/1	059150024
5915VU/2	059150127	5915VU/2	059150027
5915VU/3	059150128	5915VU/3	059150028
5915VU/AS	059150132	5915VU/AS	059150032
5915VU/4	059150145	5915VU/4	059150045
5915VU/5	059150156	5915VU/5	059150046
5935VI/2MB	059350315	5935VI/2MB	059350316
5935ET/1MB	059350331	5935ET/1MB	059350332
5941VU-M	059410001	5941VU-M	059410002
5941KART	059410011	5941KART	059410012
5953VI	059530075		
5953VG	059530085		
5954VI	059540075	5954VI	059540053
5954VG	059540085	5954VG	059540054
5957U-P	059570040	5957U-P	059570004
5957VI	059570050	5957VI	059570005
5957VG	059570070	5957VG	059570007
5958U	059580028	5958U	059580008
5980EL/A	059800241	5980EL/A	059800081
5980EL/B	059800242	5980EL/B	059800082
5980ET/A	059800262	5980ET/A	059800083

5980ET/B	059800263	5980ET/B	059800084
5980ID	059800321	5980ID	059800085
5988ROAD/7M	059880870	5988ROAD/7M	059880087
C62EV/CP	062000401		
6600 M/39	066000039		
6600 M/234	066000234		
6600 M/378	066000378		
6600 M/529	066000529		
6600 M/609	066000609		
6600 M/637	066000637		
6600 M/843	066000843		
6600 E/B10	066000925		
6600 E/B20	066000926		
6600 E/A10	066000927		
6600 E/C10	066000929		
6600 E/K20	066000983		
7190C	071900002		
7208WR 38	072080238	7238WR 38	072380238
7208WR 39	072080239	7238WR 39	072380239
7208WR 40	072080240	7238WR 40	072380240
7208WR 41	072080241	7238WR 41	072380241
7208WR 42	072080242	7238WR 42	072380242
7208WR 43	072080243	7238WR 43	072380243
7208WR 44	072080244	7238WR 44	072380244
7208WR 45	072080245	7238WR 45	072380245
7208WR 46	072080246	7238WR 46	072380246
7208WR 47	072080247	7238WR 47	072380247
7216SN 35	072160435	7216BKK 35	072160335
7216SN 36	072160436	7216BKK 36	072160336
7216SN 37	072160437	7216BKK 37	072160337
7216SN 38	072160438	7216BKK 38	072160338
7216SN 39	072160439	7216BKK 39	072160339
7216SN 40	072160440	7216BKK 40	072160340
7216SN 41	072160441	7216BKK 41	072160341
7216SN 42	072160442	7216BKK 42	072160342
7216SN 43	072160443	7216BKK 43	072160343
7216SN 44	072160444	7216BKK 44	072160344
7216SN 45	072160445	7216BKK 45	072160345
7216SN 46	072160446	7216BKK 46	072160346
7216SN 47	072160447	7216BKK 47	072160347
7216SN 48	072160448	7216BKK 48	072160348
7235B 35	072350235	7235BK 35	072350335
7235B 36	072350236	7235BK 36	072350336
7235B 37	072350237	7235BK 37	072350337
7235B 38	072350238	7235BK 38	072350338
7235B 39	072350239	7235BK 39	072350339
7235B 40	072350240	7235BK 40	072350340
7235B 41	072350241	7235BK 41	072350341
7235B 42	072350242	7235BK 42	072350342
7235B 43	072350243	7235BK 43	072350343
7235B 44	072350244	7235BK 44	072350344
7235B 45	072350245	7235BK 45	072350345
7235B 46	072350246	7235BK 46	072350346
7235B 47	072350247	7235BK 47	072350347
7235B 48	072350248	7235BK 48	072350348
7236B 35	072360235	7236BK 35	072360335
7236B 36	072360236	7236BK 36	072360336
7236B 37	072360237	7236BK 37	072360337
7236B 38	072360238	7236BK 38	072360338
7236B 39	072360239	7236BK 39	072360339
7236B 40	072360240	7236BK 40	072360340
7236B 41	072360241	7236BK 41	072360341
7236B 42	072360242	7236BK 42	072360342
7236B 43	072360243	7236BK 43	072360343
7236B 44	072360244	7236BK 44	072360344
7236B 45	072360245	7236BK 45	072360345
7236B 46	072360246	7236BK 46	072360346
7236B 47	072360247	7236BK 47	072360347
7236B 48	072360248	7236BK 48	072360348

7248G 35	072480135	7248GK 35	072480235
7248G 36	072480136	7248GK 36	072480236
7248G 37	072480137	7248GK 37	072480237
7248G 38	072480138	7248GK 38	072480238
7248G 39	072480139	7248GK 39	072480239
7248G 40	072480140	7248GK 40	072480240
7248G 41	072480141	7248GK 41	072480241
7248G 42	072480142	7248GK 42	072480242
7248G 43	072480143	7248GK 43	072480243
7248G 44	072480144	7248GK 44	072480244
7248G 45	072480145	7248GK 45	072480245
7248G 46	072480146	7248GK 46	072480246
7248G 47	072480147	7248GK 47	072480247
7248G 48	072480148	7248GK 48	072480248
7249G 35	072490135	7249GK 35	072490235
7249G 36	072490136	7249GK 36	072490236
7249G 37	072490137	7249GK 37	072490237
7249G 38	072490138	7249GK 38	072490238
7249G 39	072490139	7249GK 39	072490239
7249G 40	072490140	7249GK 40	072490240
7249G 41	072490141	7249GK 41	072490241
7249G 42	072490142	7249GK 42	072490242
7249G 43	072490143	7249GK 43	072490243
7249G 44	072490144	7249GK 44	072490244
7249G 45	072490145	7249GK 45	072490245
7249G 46	072490146	7249GK 46	072490246
7249G 47	072490147	7249GK 47	072490247
7249G 48	072490148	7249GK 48	072490248
7293NB 38	072930538		
7293NB 39	072930539	7293HN 39	072930839
7293NB 40	072930540	7293HN 40	072930840
7293NB 41	072930541	7293HN 41	072930841
7293NB 42	072930542	7293HN 42	072930842
7293NB 43	072930543	7293HN 43	072930843
7293NB 44	072930544	7293HN 44	072930844
7293NB 45	072930545	7293HN 45	072930845
7293NB 46	072930546	7293HN 46	072930846
7293NB 47	072930547	7293HN 47	072930847
7293NB 48	072930548		
7294NB 38	072940538		
7294NB 39	072940539	7294HN 39	072940839
7294NB 40	072940540	7294HN 40	072940840
7294NB 41	072940541	7294HN 41	072940841
7294NB 42	072940542	7294HN 42	072940842
7294NB 43	072940543	7294HN 43	072940843
7294NB 44	072940544	7294HN 44	072940844
7294NB 45	072940545	7294HN 45	072940845
7294NB 46	072940546	7294HN 46	072940846
7294NB 47	072940547	7294HN 47	072940847
7294NB 48	072940548		
7323M 35	073230335	7318AN 35	073180535
7323M 36	073230336	7318AN 36	073180536
7323M 37	073230337	7318AN 37	073180537
7323M 38	073230338	7318AN 38	073180538
7323M 39	073230339	7318AN 39	073180539
7323M 40	073230340	7318AN 40	073180540
7323M 41	073230341	7318AN 41	073180541
7323M 42	073230342	7318AN 42	073180542
7323M 43	073230343	7318AN 43	073180543
7323M 44	073230344	7318AN 44	073180544
7323M 45	073230345	7318AN 45	073180545
7323M 46	073230346	7318AN 46	073180546
7323M 47	073230347	7318AN 47	073180547
7323M 48	073230348	7318AN 48	073180548
7340Y 36	073400336	7340B 36	073400236
7340Y 37	073400337	7340B 37	073400237
7340Y 38	073400338	7340B 38	073400238
7340Y 39	073400339	7340B 39	073400239
7340Y 40	073400340	7340B 40	073400240

ELIMINATED ITEMS – SUBSTITUTE/RECOMMENDED ITEMS

	ELIMINATED ITEM
	SUBSTITUTE ITEM
	RECOMMENDED ITEM

7340Y 41	073400341	7340B 41	073400241
7340Y 42	073400342	7340B 42	073400242
7340Y 43	073400343	7340B 43	073400243
7340Y 44	073400344	7340B 44	073400244
7340Y 45	073400345	7340B 45	073400245
7340Y 46	073400346	7340B 46	073400246
7340Y 47	073400347	7340B 47	073400247
7360UN 35	073600335		
7360UN 36	073600336		
7360UN 37	073600337		
7360UN 38	073600338	7354N 38	073540038
7360UN 39	073600339	7354N 39	073540039
7360UN 40	073600340	7354N 40	073540040
7360UN 41	073600341	7354N 41	073540041
7360UN 42	073600342	7354N 42	073540042
7360UN 43	073600343	7354N 43	073540043
7360UN 44	073600344	7354N 44	073540044
7360UN 45	073600345	7354N 45	073540045
7360UN 46	073600346	7354N 46	073540046
7360UN 47	073600347	7354N 47	073540047
7360UN 48	073600348	7354N 48	073540048
7361UB 35	073610235		
7361UB 36	073610236		
7361UB 37	073610237		
7361UB 38	073610238	7352B 38	073520138
7361UB 39	073610239	7352B 39	073520139
7361UB 40	073610240	7352B 40	073520140
7361UB 41	073610241	7352B 41	073520141
7361UB 42	073610242	7352B 42	073520142
7361UB 43	073610243	7352B 43	073520143
7361UB 44	073610244	7352B 44	073520144
7361UB 45	073610245	7352B 45	073520145
7361UB 46	073610246	7352B 46	073520146
7361UB 47	073610247	7352B 47	073520147
7361UB 48	073610248	7352B 48	073520148
7368UN 35	073680335		
7368UN 36	073680336		
7368UN 37	073680337		
7368UN 38	073680338	7355V 38	073550038
7368UN 39	073680339	7355V 39	073550039
7368UN 40	073680340	7355V 40	073550040
7368UN 41	073680341	7355V 41	073550041
7368UN 42	073680342	7355V 42	073550042
7368UN 43	073680343	7355V 43	073550043
7368UN 44	073680344	7355V 44	073550044
7368UN 45	073680345	7355V 45	073550045
7368UN 46	073680346	7355V 46	073550046
7368UN 47	073680347	7355V 47	073550047
7368UN 48	073680348	7355V 48	073550048
7368UG 35	073680435		
7368UG 36	073680436		
7368UG 37	073680437		
7368UG 38	073680438	7355V 38	073550038
7368UG 39	073680439	7355V 39	073550039
7368UG 40	073680440	7355V 40	073550040
7368UG 41	073680441	7355V 41	073550041
7368UG 42	073680442	7355V 42	073550042
7368UG 43	073680443	7355V 43	073550043
7368UG 44	073680444	7355V 44	073550044
7368UG 45	073680445	7355V 45	073550045
7368UG 46	073680446	7355V 46	073550046
7368UG 47	073680447	7355V 47	073550047
7368UG 48	073680448	7355V 48	073550048
7369UB 35	073690235		
7369UB 36	073690236		

7369UB 37	073690237		
7369UB 38	073690238	7355V 38	073550038
7369UB 39	073690239	7355V 39	073550039
7369UB 40	073690240	7355V 40	073550040
7369UB 41	073690241	7355V 41	073550041
7369UB 42	073690242	7355V 42	073550042
7369UB 43	073690243	7355V 43	073550043
7369UB 44	073690244	7355V 44	073550044
7369UB 45	073690245	7355V 45	073550045
7369UB 46	073690246	7355V 46	073550046
7369UB 47	073690247	7355V 47	073550047
7369UB 48	073690248	7355V 48	073550048
7578G XS	075780000		
7578G S	075780001	7579T S	075790001
7578G M	075780002	7579T M	075790002
7578G L	075780003	7579T L	075790003
7578G XL	075780004	7579T XL	075790004
7578G XXL	075780005	7579T XXL	075790005
7578G XXXL	075780006	7579T XXXL	075790006
7685BL S	076850101	7685 S	076850001
7685BL M	076850102	7685 M	076850002
7685BL L	076850103	7685 L	076850003
7685BL XL	076850104	7685 XL	076850004
7685BL XXL	076850105	7685 XXL	076850005
7815N XS	078150000	7880SC XS	078800000
7815N S	078150001	7880SC S	078800001
7815N M	078150002	7880SC M	078800002
7815N L	078150003	7880SC L	078800003
7815N XL	078150004	7880SC XL	078800004
7815N XXL	078150005	7880SC XXL	078800005
7815N XXXL	078150006	7880SC XXXL	078800006
7930P XS	079300100	7930G XS	079300300
7930P S	079300101	7930G S	079300301
7930P M	079300102	7930G M	079300302
7930P L	079300103	7930G L	079300303
7930P XL	079300104	7930G XL	079300304
7930P XXL	079300105	7930G XXL	079300305
7930P XXXL	079300106	7930G XXXL	079300306
7931P XS	079310100	7931G XS	079310300
7931P S	079310101	7931G S	079310301
7931P M	079310102	7931G M	079310302
7931P L	079310103	7931G L	079310303
7931P XL	079310104	7931G XL	079310304
7931P XXL	079310105	7931G XXL	079310305
7931P XXXL	079310106	7931G XXXL	079310306
7933P XS	079330100	7933G XS	079330300
7933P S	079330101	7933G S	079330301
7933P M	079330102	7933G M	079330302
7933P L	079330103	7933G L	079330303
7933P XL	079330104	7933G XL	079330304
7933P XXL	079330105	7933G XXL	079330305
7933P XXXL	079330106	7933G XXXL	079330306
7935P XS	079350100	7935G XS	079350300
7935P S	079350101	7935G S	079350301
7935P M	079350102	7935G M	079350302
7935P L	079350103	7935G L	079350303
7935P XL	079350104	7935G XL	079350304
7935P XXL	079350105	7935G XXL	079350305
7935P XXXL	079350106	7935G XXXL	079350306
7939P XS	079390100	7939G XS	079390300
7939P S	079390101	7939G S	079390301
7939P M	079390102	7939G M	079390302
7939P L	079390103	7939G L	079390303
7939P XL	079390104	7939G XL	079390304
7939P XXL	079390105	7939G XXL	079390305
7939P XXXL	079390106	7939G XXXL	079390306
7971E XS	079710000	7971L XS	079710100
7971E S	079710001	7971L S	079710101
7971E M	079710002	7971L M	079710102
7971E L	079710003	7971L L	079710103

7971E XL	079710004	7971L XL	079710104
7971E XXL	079710005	7971L XXL	079710105
7971E XXXL	079710006	7971L XXXL	079710106
7973 XS	079730000		
7973 S	079730001		
7973 M	079730002		
7973 L	079730003		
7973 XL	079730004		
7973 XXL	079730005		
7973 XXXL	079730006		
7978E XS	079780000	7978L XS	079780100
7978E S	079780001	7978L S	079780101
7978E M	079780002	7978L M	079780102
7978E L	079780003	7978L L	079780103
7978E XL	079780004	7978L XL	079780104
7978E XXL	079780005	7978L XXL	079780105
7978E XXXL	079780006	7978L XXXL	079780106
7981T	079810111	7980R	079800111
8016DF 6	080160066		
8016DF 8	080160068		
8016DF 10	080160070		
8016FR 10	080160260		
8016FR 13	080160263		
8016FR-2K 10	080169760		
8016FR-2K 13	080169763		
8029 57	080290057	8029R 50	080290150
8029 65	080290065	8029R 57	080290157
8029 70	080290070	8029R 65	080290165
8031 70	080310070	8031R 65	080310165
8105 1"1/4X24	081050033		
8188FG3 3,5	081880630		
8600 R/10	086000010		
8600 R/112	086000112		
8600 R/224	086000224		
8600 R/411	086000411		
8600 R/514	086000514		
8600E/R	086000917		
9504 S	095040001		
9504 M	095040002		
9504 L	095040003		
9504 XL	095040004		
9505 S	095050001		
9505 M	095050002		
9505 L	095050003		
9505 XL	095050004		
9505 XXL	095050005		
9508K S	095080011	9508TL S	095080051
9508K M	095080012	9508TL M	095080052
9508K L	095080013	9508TL L	095080053
9508K XL	095080014	9508TL XL	095080054
9521W	095210111	9521OB	095210021
9524SC 1:43	095240043		
9539C/B M	095390000	9539CB S/M	095390010
9539C/B L	095390001	9539CB L/XL	095390011
9542A S	095420032	9542AT S	095420072
9542A M	095420033	9542AT M	095420073
9542A L	095420034	9542AT L	095420074
9542A XL	095420035	9542AT XL	095420075
9542A XXL	095420036	9542AT XXL	095420076
9542A XXXL	095420037	9542AT XXXL	095420077
9544	095440100		
9545	095450100		
9593CV	095930115	9593M	095930120
9598A M	095980100		
9598A L	095980102		
9598B S	095980198		
9598B M	095980200		
9598B L	095980202		



Abrasive discs	471-472, 479
Abrasive shaft-mounted wheels	472÷474
Adjustable wrenches	36, 246, 260, 266
Amperometric clamps	208
Anti-waste rolls	479
Assortments of tools in thermoformed trays	439÷463
Auto-darkening LCD mask	220
Automatic cable reels with inspection lamps	218
Automatic hose reel for compressed air or cold water	290-291
Barrel pumps	223
Battery tools	271÷273
Beta Abrasives	470÷479
Beta Chemicals	466÷469
Beta Collection	585÷594
BetaEasy screwdrivers	129÷131
BetaGrip screwdrivers	134÷137, 249
BetaMax screwdrivers	138÷140, 261, 269
Bevel gearbox	81
Bevel protractor	192
Bicycle tools	240÷243
Bit reamers	197
Bits and bit holders	36, 38, 74÷82, 133, 246
Bits for drilling, threading and countersinking	54
Blister pack range	486÷497
Bolt cutters	122
Bonding guns	203-204
Bottle holders	316
Bristle brush	201
Brushes	201, 571
Cable cutters	125
Cable cutters for steel cables	125
Cable stripping tools and wire stripping pliers	125-126
Callipers	193
Cape chisels	24
Carpenter's pencil	194
Centre punches	23
Chalk line reels and powder	196
Circlip pliers	117-118, 268
Closed end terminals	482
Combination pliers	126, 249, 260, 269
Combination wrenches	24÷26, 36-37, 259, 264
Covers for tool chests	333
Crimping pliers for terminals and terminals	187÷189, 481
Crowfoot wrenches, 3/8" square drive	89
Cutting nippers for electronic purposes	128-129
Desoldering pumps	215
Diagonal and end cutting nippers	121, 128-129, 248, 260, 269
Dial indicators	191
Dies and assortments	54÷57
Digital litre counter for oil	223

INDEX



Digital tachometer	209
Display units for sales points	498÷511
Double ended hexagon / bi-hex offset socket wrenches	104, 268
Double swivel end socket wrenches	28
Double-ended offset ring wrench for scaffolding bolts	29, 266
Drift punches	23, 264
Electrician's scissors	124, 248
Electronic torque meter with Dynatester transducer	61, 68
Electronic videoscope	112
Engineer's scribes	192
Extractors for damaged screws and studs	150
Extra-flat chisels with straight cutters	115, 142
Files	142, 198÷200, 271
Filtering mask	561
Fitting tool for ties and ties	485
Fixed frame hacksaw	201
Flap discs	474÷477
Flap/non-woven wheels	477-478
Flare nut open ring wrenches	30, 36
Flat chisels	23, 264
Flexible magnetic pickup tools	197
Flexible pickup tools	197
Fluid extractor	223
Friction tape	485
Graduated rules	193
Hacksaw frames and blades	200-201, 271
Hammers	142-143, 146÷149, 261, 269-270
Hand crimper steel matrix	120
Hand punch steel punch and matrix	120
Hand sockets, accessories and assortments, 1/4"	82÷86
Hand sockets, accessories and assortments, 3/8"	87÷92, 246-247
Hand sockets, accessories and assortments, 1/2"	92÷100, 260, 247-248, 267
Hand sockets, accessories and assortments, 3/4"	101-102, 267-268
Hand sockets, accessories and assortments, 1"	102
Hand taps and assortments	51-52, 56-57
Heat guns	218-219
Heating plates for manual straight and slanted welding of plastic pipes	39
Heavy-duty cable cutters	122
Hi-torque hexagon nut spinners with handles	105, 248
Holesaws and hole cutters and accessories	57÷59
Hook wrenches	35, 266
Hot glue guns	219
Hub and wheel drum pullers	181
Hydraulic press	185
Hydraulic pullers	185-186
Impact screwdrivers	139-140
Impact sockets, accessories and assortments	68÷74
Industrial tool chests	322-323
Inspection mirrors	197
Instant glue	468
Insulated tools, 1000V	244÷252

INDEX



Insulating gloves	250
Insulating mat	250
Kneeling pad	229
Knives	212-213, 271
Lamps	215÷218
Lever clamps	186
Lever operated grease guns	204
Lever-operated grease gun	204
Lifting airbag	213
Liquid gasket	467-468
Locker	468
Locking wire pliers	210
Long and extra-long nose pliers	116-117, 126÷128, 249, 269
Lump hammers	148, 270
Magnetic tool holders	211
Magnetizer/demagnetizer	129
Mains testing screwdrivers	133
Masonry chisels	195-196
Measuring tapes	194
Metric feeler gauges	197
Micrometers	190-191
Microscrewdrivers	133-134
Mobile roller cabs	306÷318, 324-334, 357-358
Mobile workstation	321
Morse taper extractors	51
Motorcycle tools	236÷243
Multilayer pipe gauge	41
Multimeters	207-208
Nut splitters	197
Nylon clamps	482÷485
Nylon wire puller	189
Offset key wrenches for hexagon and Torx® head screws, with high torque handles	33÷35, 248, 260
Offset key wrenches for hexagon and Torx® head screws	30÷35, 259, 266
Offset key wrenches with XZN® profile	35
Offset screwdrivers	132
Oil cans	204-205
Oil gun	223
Oil pressure pump	143
Panel toolholders	344, 366, 379
Paper roll holders	316
Parallel bench vices	186-187
Pen oiler	205
Pin punches	23, 264
Pincers	122
Pipe benders	44
Pipe cutters	39-40, 266
Pipe reamers	41
Pipe wrenches	43-44, 266-267
Pivoting clamp vices, for plumbing purposes	45
Plastic barrier chains and posts	561
Plastic repair kit	145

INDEX



Pliers for electronic purposes	127-128
Plumbing tools	38÷45
Pneumatic tools and accessories	274÷293
Polywelders and forms	38-39
Portable tool chests	304-305, 329-330
Pre-insulated terminals	481
Protractors	192
Pry bars	112-113, 196, 268
Pullers	180÷182
Punch press	189
Punches	122-123
Radius gauges	196
Ratcheting wrenches	29, 36÷38
Ratchet-type shears for PVC pipes	40-41
Reversible screwdrivers	137-138
Revolving punch pliers	210
Ring wrenches	28÷30, 246, 265-266
Riveting pliers and rivets	202÷203
Robur wire rope accessories	550÷584
Safety footwear	512÷534
Safety goggles	561
Scissors	124-125, 213, 248, 271
Scrapers	164, 198, 212, 271
Screw clamps	186
Screw pitch gauge	196
Screwdrivers with steel heads	132
Screwholding screwdrivers	132
Seat with castors	228
Self-locking pliers	119-120
Shears	123
Single and double open end wrenches	26-27, 246, 265-266
Sledge hammers	148, 270
Slip joint pliers, boxed joints	118, 126, 248, 260, 269
Slogging wrenches	27-28, 265-266
Soft face hammers	148-149, 270
Soldering irons	213÷215
Sparkproof axe	271
Sparkproof pick	271
Sparkproof safety valve wrenches	268
Sparkproof shovel	271
Sparkproof tools	263÷271
Special end mills for welding	48-49
Spirit levels and levelling staffs	195
Spray cleaner	469
Spray grease	469
Spray silicone	469
Spray unlocking lubricant	468
Spray zinc	469
Spring puller	200
Spring tweezers	115-116
Squares	191-192

INDEX



Stainless steel helicoids	53-54
Stainless steel tools	258÷261
Stepped drills	49
Suction lifters	210
Support for impact wrenches	277
Tap wrenches and die stocks	53, 55
Tethered tools	251÷262
T-handle socket wrenches for hexagon and Torx® head screws	105÷108
T-handle wrenches with three male ends for hexagon and Torx® head screws	106÷108, 248, 268
Thermoformed tool trays	440÷463
Thermometers	209-210
Thread sealant	467
Threadlocker	466-467
Three-leg pullers	180, 186
Tool accessories for cabinets, drawers and panels	463÷465
Tool assortments	392÷438
Tool bags	295, 298-299
Tool boxes	299÷301
Tool cabinets	341, 368
Tool cabinets, sheet metal	369-370, 380
Tool cases	295÷297
Tool chest trolleys	304
Tool pouches with belts	295
Tool rucksack	298
Tool trolleys, 2 wheels	296, 298-299, 335÷338
Tool trolleys, 4 wheels	318÷320, 339-340, 362
Tool trunks	301
Torches	215
Torque angle indicators	63
Torque bars	63÷66
Torque multipliers	59÷61
Torque screwdrivers	61
Torque wrenches and bars	61÷68
Tube flaring tools	41-42
Tubular socket wrenches	103-104
Twist drills with cylindrical shanks	45÷48
Two-leg pullers	178÷180, 185
Ultrasonic cleaning tank	227
Utility knives	211-212
Vacuum cleaners for solid and fluid	220÷222
Vehicle repair	108÷115, 140÷146, 149÷178, 180÷185, 205÷211, 222÷235
Voltage tester	209
Warning and prohibition signs	561
Welding machines	220
Wood rip saw	201
Work mat	347, 371, 594
Workbenches	341÷347, 352÷354
Workshop Equipment	348÷381
Workshop verniers	189-190
Workwear	536÷562

INDEX OF CAR VEHICLE TOOLS



Acid densimeter, glass body	207
Adjustable body blade holders with flexible flat blades	142
Air conditioner charging station	226
Air hydraulic jack	234-235
Antifreeze densimeter, glass body	207
Automatic gearbox station	224-225
Ball joint pullers	184
Battery chargers	175÷177
Battery fillers	206
Battery lug and post cleaner steel brush	201
Bench sander	227
Brake fluid extractor	159
Brake spring pliers	159
Car protectors	228
Chain opening tool	239
Claw hammers	142-143
Clip pliers	210
Clutch aligners	151
Compressors for shock absorber springs	182÷184
Cooling system seal testers	207
Creepers	229
Curved angled spoons	141-142
Dent puller	143
Dent reflector	143
Diesel injector test and calibrating hand pump	111
Digital pressure and compression tester	157÷159
Dollies	140-141
DSG lever	151
Engine brackets	230
Engine oil-filter wrenches	169÷171
Exhaust pipe expanders	162-163
Exhausted oil drain units	222
External butt-ended circlip pliers	152
Feeler gauges for car body repair shops	142
Fluid collection tank	222
Folding hydraulic crane	231
Four-way hexagon wheel nut wrenches	114
Gas oil filter wrenches	170-171
Gauge for tyre threads	196
Gearbox/transmission trolley	340
Heavy vehicle tools	113
Heavy vehicle wheel hub nut locking sockets	113

INDEX OF CAR VEHICLE TOOLS



Homokinetic joint pullers	185
Hose clamp pliers	160÷162
Hose pliers	164-165
Hydraulic bottle jacks	230
Hydraulic car jack with wheels	233-234
Hydraulic pit and under bridge jack	231-232
Hydraulic press	232-233
Impact sockets for axle nuts	113
Impact sockets for wheel nuts	69-70
Instrument for controlling compression on petrol and Diesel engines	110
Jack and positioner for truck wheels	229
Jack stands	230
Kit for filling diesel oil filters	164
Leaf spring pin sockets	184
Lever for removing wishbone heads from pil	185
Male guide pins for wheel installation	114
Mobile workstation for diagnostic tools	339
Motorcycle stands	237
Oil seal wrenches	171-172
Packing removal tool	181
Parking sensor punches	145
Piston ring compressors	151
Plastic funnel	206
Pneumatic dent puller	143
Pneumatic valve grinder	152
Quick coupler pliers for fuel pipes	165
Reamers for cleaning injector seats	111
Rubber-covered aluminium foil, formable	206
Signal detector	209
Sliding gauges for brake discs and drums	189-190
Sockets for Diesel engine injectors	108-109
Sockets for Lambda probes	109
Sonoscope probe	178
Spark plug pliers	162
Spark plug wrenches and sockets	108-109
Spring pulling hook wrenches	149
Square impact sockets for Isuzu wheel nuts	73
Starters	173÷175
Stopping knives made of stainless steel	142
Striking tools for installing conical bearings and oil seals	185
Telescopic rod	211
Temperature sensor wrenches	109-110
Tester for batteries and recharging systems	177
Timing devices	152÷156
Tool for disc brake pistons	160
Tool for removing and inserting silentblocks	185
Tools for airbag	150

INDEX OF CAR VEHICLE TOOLS



Tools for air-conditioning systems	166
Tools for common rail diesel injector	110-111
Tools for pulling out car radios	210
Tools for releasing electrical connectors	173
Tools for removing broken glow plugs	110
Tools for removing glass windows	210-211
Tools for spark plug coils	162
Tools for tyre valves	114-115
Torsion bars for wheel nuts	74
Trim pin removers	163-164
Tyre inflator	290
Tyre levers	112
Tyre pressure sensor tool	113
Underbody trolley for vehicles	229
Valve depressors for disc removal	159
Valve seat removing tool	152
Valve spring compressors	151
Valve timing system pulley locking tools	156
Vapour extractor	111
Voltage stabilizer	177
Voltage tester	173
Wheel balancing weight tool	115
Wheel hub nut locking sockets	113
Wheel lifter	229
Wheel nut plastic cap pliers	114
Wheeled bodywork spotter	144-145
Window trim tool remover	211
Wrench for natural gas cylinder valves	167-168
Wrench for removing steering arms	185
Wrench for turbines	163
Wrenches for fuel connectors	155
Wrenches for fuel tank floating ring nuts	165

 **Beta**

ALPHANUMERIC INDEX

1		1032HS	254	1080D	121	11276B	477	1162MQ	249
		1032K	490	1081	121	11276C	477	1164	127
		1033	117	1082	121	1128BAX	124,492	1164BM	127
100	35	1033K	490	1082BA	269	1128BAX-HS	254	1164BMK	493
100/KIT	35	1034	117	1082BM	121	1128BCX	124,492	1164K	493
110BA	266	1034HS	254	1082BM-HS	254	1128BM	124	1164MQ	249
110MQ	246	1034K	490	1082BMK	491	1128BMX	124	1166	127
111	36	1034L	117	1082INOX	260	1128BSX	124	1166BA	269
111G	36	1036	117	1082K	491	1128FX	124,492	1166BM	127
111HS	253	1036BA	268	1082MQ	248	1128FXS	124	1166BM-HS	255
111INOX	260	1036HS	254	1084	121	1128MQ	248	1166BMK	493
111K	488	1036K	491	1084BM	121	1129BM	124	1166K	493
111N	36	1037	118	1084BMK	491	1129BMK	492	1166MQ	249
120	36	1037K	491	1084K	491	1130BMX	125	1168	127
123E1/4	36	1038	118	1084MQ	248	1131CK	125	1168BM	127
123/K4	36	1038HS	254	1088	121	1132	125	1168BM-HS	255
123Q1/2	36	1038K	491	1088BM	121	1132BM	125	1168BMK	493
123Q1/4	36	1039	118	1088BM-HS	254	1132BM-HS	254	1168K	493
123Q3/8	36	1044	118	1088BMK	491	1132BMK	492	1168MQ	249
141	36	1044F	118	1088K	491	1132K	492	1171BM	127
141/B	37	1044FK	491	1088MQ	248	1132MQ	248	1172BM	127
141/S	37	1044K	491	1092V	121	1133	125	1172BM/P	127
142	37	1046	118	1094V	121	1133RL	125	1173BM	127
142AS	37	1046BA	269	1095N	121	1134	125	1175BM	128
142AS/S	37	1046K	491	1096	122	1134A	125	1177BM	128
142/B	37	1047	118	1096K	491	1134A/RL	125	1177BM/Z	128
142C	37	1047BM	118	1098	122	1134RL	125	1178BM	128
142HS	253	1048	118	1098K	491	1136	125	1178BM/P	128
142K	488	1048BM	118	1098PL	122	1137BA	269	1182BM	128
142/S	37	1048BM-HS	254	1098PLK	491	1137BA/RC	269	1183BM	128
142/SC91-E	37	1048INOX	260	1101	122	1142BM	125	1184BM	129
142SN	37	1048K	491	1101R	122	1142BMK	492	1185BM	129
142SN/S	37	1048MQ	248	1102	122	1142MQ	249	1186BM	129
186 8-32	38	1048V	119	1104	122	1143	125	1188BM	129
187	38	1048VK	491	1104R	122	1143R	125	1190BM	129
187/B5	38	1050	119	1105	122	1144D	126	1191BM	129
188	38	1051	119	1105AD-50	123	1144D/RG	126	1191BM/L	129
192	38	1051GM	119	1105T30	122	1144D/RL	126	1191R/5-M	129
192/S2	38,488	1051L	119	1105T50	122	1144G	126	1200MS	129
194	38	1051XL	119	1105/C15T	123	1144G/RL	126	1201	129
195	38	1052	119	1105/C29T	123	1148A	126	1201/S	130
195AS	38	1052BA	269	1112	123	1148A/R	126	1201DZ	130
195AS/B4	38	1052HS	254	1112K	492	1148B	126	1201K	493
195K	488	1052K	491	1114	123	1148B/R	126	1201N	130
195P	38	1053	119	1118	123	1149F	126	1201NK	493
195P/B5	38	1054	119	1120A	123	1150	126	1202	130
1002	116	1055	119	1120ARL - ARG	123	1150BA	269	1202/S	130
1008	116	1056	119	1122	123	1150BM	126	1202K	493
1008BM	116	1057A	119	1122 - 1125MOL	124	1150BM-HS	255	1202L	130
1009	116	1058	120	1122K	492	1150BMK	493	1202N	130
1009L/A	116	1060	120	1123	123	1150HPC	126	1202NK	493
1009L/B	117	1061	120	1123K	492	1150INOX	260	1203/D	130
1009L/C	117	1062	120	1124	123	1150K	492	1203/E1P	500
1009L/D	117	1062AL	120	1124K	492	1150MQ	249	1203/E4P	500
1009L/DP	117	1062GM	120	1125	123	1153	126	1203/E5P	500
1010	117	1063	120	1126	123	1153INOX	260	1203/E10P	500
1010BM	117	1064	120	1127	124	1162	126	1203/S10	130
1010MQ	248	1065F	120	11271A	477	1162BA	269	1204	131
1031/S4	117	1065P	120	11271B	477	1162BM	127	1204/S	131
1032	117	1077	120	11271C	477	1162BMK	493	1204K	493
1032BA	268	1078	121	11276A	477	1162K	493	1204L	131

ALPHANUMERIC INDEX

1205ES	131	1263/D...	135	1281TX	137	1313	141	1368G/K400	145
1205ES/S	131	1263/E39	501	1290	138	1314	141	1368G/OD	145
1207TX	131	1263/E40	501	1290/S...	138	1326	141	1368G/SD	145
1207TX/D	131	1263/E50	501	1290HS	255	1327	141	1369/C11	146
1207TXK	493	1263/E62	501	1290INOX	261	1328	141	1370	146
1208RTX	131	1263/E70	501	1290K	495	1329	142	1370/MR...	146
1208RTX/D	131	1263/E74	500	1290K/INOX	495	1330	142	1370BA	269
1208RTXK	493	1263/E78	500	1290N	138	1331	142	1370BA/MR	269
1209N/PZ	131	1263/E85	501	1290NK	495	1335BM	142	1370BA/PL	269
1209N/PZK	494	1263/S12	135	1292	138	1337/S5	142	1370F	146
1209PZ	131	1264	135	1292/S	138	1338	142	1370F/MR...	146
1209PZ/S	131	1264/S	135	1292HS	255	1338A - 1338B	142	1370FT	146
1209PZK	494	1264K	494	1292INOX	261	1338R9 - 1338R12	142	1370FT-HS	255
1229LP	132	1264L	136	1292K	495	1342	142	1370INOX	261
1229LP/S	132	1265ES	136	1292K/INOX	495	1342PM	142	1370T	146
1229LPH/A6	132	1265ES/S	136	1292L	138	1342PMR	142	1370T-HS	255
1229PH	132	1266BP	136	1292N	138	1343	142	1374F	146
1236B	132	1266BP/S	136	1292NK	495	1344	142	1374F/MR...	146
1238B	132	1267TX	136	1293/D...	139	1345	142	1375	147
1241	132	1267TX/D	136	1293/S...	139	1351	142	1375/MR	147
1242	132	1267TX/S	136	1293BP	139	1353	142	1375A	147
1243/D7	132	1267TXK	494	1293BP/S	139	1357Z/45	143	1375B	147
1250	132	1268RTX	136	1293BX/DA	502	1359T	143	1375BA/PL	270
1251	132	1268RTX/S	136	1293BX/DD	502	1360/K6	143	1376X	147
1252/S5	132	1268RTXK	494	1293BX/DE	502	1360/KP3	143	1376X/MR	147
1253	133	1269N/PZ	137	1293BX/DF	502	1361/C12	143	1376XT	147
1253A	133	1269N/PZK	495	1293ES	139	1362	143	1376XT/MR	147
1254	133	1269PZ	136	1293ES/S	139	1365/K13	143	1377	147
1256/20	133	1269PZ/S	136	1293INOX/D8	261	1365P10	143	1377/MR...	147
1256/30	133	1269PZK	494	1294	139	1366/K5	143	1377BA	270
1256/C36-2	133	1270BA	269	1294/S	139	1366A	143	1377BA/PL	270
1256LP	133	1272BA	269	1294HS	255	1366KF	143	1377INOX	261
1256PE	133	1272MQ	249	1294K	495	1366S	144	1377T	147
1256PH	133	1272MQ/F	249	1294L	139	1366S-KIT	144	1378	147
1256PZ	133	1272MQ/S	249	1295	139	1366SL	144	1378/MR...	147
1256RTX	133	1273MQ/D6	249	1295/C14	140	1366S/R1	144	1379BA	270
1256TX	133	1273MQ/E1	502	1297TX	140	1366S/R2	144	1379F	147
1257BE	134	1273MQ/E2	502	1297TX/D	140	1366S/R3	144	1379F/MR...	148
1257ES	134	1273MQ/F-D6	249	1297TX/L	140	1366S/R4	144	1380	148
1257ESB/S8	134	1274MQ	250	1297TX/L-S5	140	1366S/R5	144	1380/MR...	148
1257LP	133	1274MQ/F	249	1297TX/S	140	1366S/R6	144	1380BA	270
1257LP/S8	134	1274MQ/S	250	1298RTX	140	1366S/R7	144	1380BA/MR	270
1257LPH/S8	134	1275MQ/C	250	1298RTX/S	140	1366S/R8	144	1380BA/PL	270
1257PH	134	1276MQ/C	250	1298RTXK	495	1366S/R9	144	1380S	148
1257TX	134	1277BA	269	1299HS	255	1366S/R10	144	1380S/MR...	148
1257TX/S8	134	1279MQ	250	1299N/PZ	140	1366S/R11	144	1380T	148
1260	134	1279MQ/F	250	1299N/PZK	495	1366S/R12	144	1381	148
1260E	135	1279MQ/S	250	1299PZ	140	1366S/R13	145	1381/MR...	148
1260EK	494	1281/B28A	138	1299PZ/S	140	1366S/R14	145	1381BA	270
1260K	494	1281BG	137	1299PZK	495	1366S/R21	145	1381BA/MR	270
1260N	134	1281BG/A9	137	1302	140	1366S/R22	145	1381BA/PL	270
1260NK	494	1281BG/B28A	138	1303	141	1366S/R24	145	1381T	148
1260/S	134	1281BG-TX/A8	137	1304	141	1366S/R25	145	1385	148
1262	135	1281LP	137	1305	141	1366S/R26	145	1385/MR	148
1262/S	135	1281LPH	137	1305Z	141	1366ST	144	1390	148
1262E	135	1281PB	137	1306	141	1367	145	1390/MR...	148
1262EK	494	1281PE	137	1307	141	1367/S4	145	1390BA	270
1262K	494	1281PH	137	1308	141	1367/S6	145	1390BA/R	270
1262L	135	1281PM	137	1309	141	1368	145	1390HS	255
1262N	135	1281PZ	137	1310	141	1368G/C2U	146	1390N	149
1262NK	494	1281RTX	137	1312	141	1368G/CV	145	1390NR	149

ALPHANUMERIC INDEX

1390R	149	1461/C23B	154	1471PN/B2	160	1482A/1	165	1493B/S5	169
1391	149	1461/C24B	154	1471PN/B3	160	1482A/2	165	1493/C7	171
1391A	149	1461/C25G	154	1471PN/B4	160	1482A/3	165	1493/C19	170
1392	149	1461/C26B	155	1471PN/B5	160	1482A/4	165	1493/C30	170
1392HS	256	1461/C27G	155	1472	160	1482A/5	165	1493DSG	170
1392R	149	1461/C28B	155	1472AU	160	1482B	165	1493FF	170
1393	149	1461/C29B	155	1472AU/P	161	1482C	165	1493FT	170
1410/M	149	1461/C30G	155	1472AU/RP	161	1482D	166	1493H	171
1428	149	1461/C31B	155	1472FC	161	1483/K12	166	1493J	170
1428/SB11	149	1461/C32G	155	1472FC/GE	161	1483K/22	166	1493/PF	170
1428L	149	1461/C33B	155	1472FC/L	161	1483KV-PT/S7	78,166	1493/S-U	171
1428L/B3	149	1462AD/BSC	156	1472FCA	161	1484	166	1493VW	171
1429	150	1462AD/SMN	156	1472FCL/RP	161	1485BP	166	1493X	171
1429/SB7	150	1462CF	155	1472H	161	1485BPM	166	1493Y	171
1430/...	150	1462CF/C6	155	1472MT/VW	161	1485FCA/K2	166	1494	171
1430/S	150	1462/EI	156	1472R/AU	161	1485FCA/T	166	1494BMW	171
1431/C5	150	1462/KD	156	1472TM	161	1485FCA/TS	166	1494/C14A	172
1433	150	1462/KI	156	1472VW	161,495	1485FRD/T	166	1494E	171
1433/C11	150	1462/KMRC	156	1473	161	1485/KIT	166	1494FPC	171
1435	150	1462/KU	156	1473A	162	1485MJ	166	1494M	172
1435/1	150	1462PIM	156	1473FN	162	1485MTJ/1.3	167	1494Q	171
1435/1R	150	1463/KIT	156	1473P	162,495	1485PMTJ	167	1494T	171
1435R	150	1464ADB	158	1473Q	162	1485R	167	1494VW	172
1437/C12	150	1464AP	157	1473T	162	1485R/P10	167	1494VW/K	172
1438	150	1464AP T	157	1474/C4	162	1485R/P17	167	1494XZN	172
1438DSG	151	1464AP T16X12	157	1474DL	162	1485TC	167	1495/C6	172
1438EVO	151	1464APB	157	1474E/VW	162	1485VAG	167	1495M	172
1438K/DSG	151	1464FAP	158	1474G	162	1485VAG/K2	167	1495T	172
1438R	151	1464FG	157	1474L	162	1486/10	167	1496/C	172
1438SAC	151	1464FG/CP4	157	1475U	162	1486/20	167	1497/C23	173
1439/K7	151	1464IC	157	1476	162	1486/30	167	1497/C94	173
1440/...	151	1464IC/RK	157	1476/RC	162	1486/40	167	1497CEL	172
1445/1 - 1445/2	151	1464PB	158	1476A	163	1486/50	167	1497D	173
1450GC	151	1464PF	158	1476A/RC	163	1486/60	168	1497P	173
1452K	151	1464PT	158	1476C/1 - 1476C/2	163	1486/70	168	1497RC	173,495
1452PN/K	151	1464T	157	1476GT	163	1486/80	168	1498	173
1455SVP	152	1464TDI	158	1476PSA	163	1486/90	168	1498/12	174
1455SVP/R...	152	1464VD	158	1476T	163	1488 - 1488L	168	1498/12-/24 R20	175
1457/B4	152	1465	158	1477/C10	163	1488/1	168	1498/2A	175
1458	152	1466/C5	159	1477D	163	1488R...	168	1498/2A-8A-PR	176
1460F	152	1466L 11	159	1477D/S5	163	1489/31T	168	1498/4A	175
1461/C3B	152	1466TLF	159	1477K/7	163	1489/33	168	1498/4A-8A CO	175
1461/C5G	152	1467	159	1478	163	1489/33P	168	1498/4A-8A CP	175
1461/C6B	152	1467/RK1	159	1478/3P	163	1489/C14	168	1498/8A	175
1461/C6G	152	1467/RK2	159	1478T	163	1489/E	168	1498/16A	176
1461/C7B	152	1467LF	159	1479	164	1489R	168	1498/24	174
1461/C8B	153	1467LF/RC	159	1479/B27	164	1489/Y	168	1498/30A	176
1461/C8G	153	1468N	159	1479L/S2	164	1490/1 - 1490/2	169	1498/40A	177
1461/C9B	153	1470	159	1479ML/S3	164	1490 /R1 - 1490 /R2	169	1498/50A	176
1461/C10G	153	1470FT	159	1479N/S5	164	1490F	169	1498/120A	176
1461/C11A	153	1471	159	1479RB/1	164	1491	169	1498B12/R02	175
1461/C11G	153	1471A	159	1479RB/2	164	1491A	169	1498C/24	175
1461/C12A	153	1471CF	160	1479RB/3	164	1491R	169	1498CM/12	173
1461/C12G	153	1471CM	160	1479U/13	164	1491T	169	1498LT/12	174
1461/C13A	153	1471CM/E11	160	1479U/32	164	1492/1 - 1492/2	169	1498LT/12-R7	174
1461/C13B	154	1471D2	160	1480	164	1492T	169	1498LT/12-SF	174
1461/C17B	154	1471M/50	160	1481/C12	164	1493	169	1498MN/12	173
1461/C18B	154	1471M/C22	160	1481PL	165	1493AL	170	1498MN/12-C	174
1461/C20G	154	1471M/P	160	1481PL/S3	165	1493AL 4S	170	1498MN/12-P	174
1461/C21G	154	1471M/W50	160	1482	165	1493AL CF	170	1498MN/12-R	174
1461/C22B	154	1471PN/B1	160	1482/8 - 1482/10	165	1493B	169	1498MN/12-U	174

ALPHANUMERIC INDEX

1498PC	177	1555/QS	183	1608	188	1676	192	1708HS/20	256
1498SA/2A-4A	175	1555S/BMW-RNT	183	1608A	188	1678/C3	192	1709/10 - 1709/18	197
1498SM	177	1556/1A	184	1608/C9	188	1679	193	1710	197
1498SM-A	177	1556/2A	184	1609	188	1679 /PR	193	1712E/1 - 2 - 3	197
1498SM-C	177	1557	184	1609A	189	1680	193	1712E/L1	197
1498SM-CP	177	1557/S3	184	1609B	189	1680A	193	1712E/R-L1	197
1498ST/TB	177	1557V	184	1609C/C5	189	1680B	193	1712TF	197
1498ST/TB ROT	177	1558/C4	118,184	1609M	189	1680C	193	1713M	197
1498TB/12-24	177	1558P	184	1610-B	481	1682	193	1714	197
1498TC	178	1559	184	1614-P	481	1682HS	256	1715	197
1499	178	1559V/8T	184	1616-SM	481	1683	193	1715B/R5L	197
1500/...	178	1560/1 - 1560/2	184	1618-SF	481	1685/C7	193	1715FL/A	197
1500/SP	178	1560A	184	1620-M	481	1687A	193	1715FL/B	197
1500G/...	178	1561/...	184	1622-F	481	1687AC	193	1715R/FL	197
1500N/...	178	1562D	184	1624-FI	481	1687D	193	1716A	197
1500N/G...	178	1565/1 - 2 - 3	184	1628-C	481	1687U	194	1716P	197
1500N/SP	178	1566/GO1	185	1630-CR	481	1687/S4	194	1716Q	197
1501/1 - 2 - 3	179	1566N	185	1632-TS	481	1688	194	1716R	197
1501G/1 - 2 - 3	179	1566P	185	1634-TD	481	1688A	194	1716U	197
1501Z/S - P - R	179	1567	185	1635-K	482	1688M	194	1717A	198
1505/C5	179	1569/A	185	1635-S	482	1688PC	194	1717B	198
1505V	179	1569/B	185	1639EAB	485	1688PC/R	194	1717BA	271
1506	179	1569/F	185	1639ESB	485	1690F	194	1717BA/1	271
1508/1 - 1508/2	179	1569CP	185	1639ESC	485	1690L	194	1717C	198
1511/1 - 2 - 3	179	1570/3	185	1639ETA	485	1691BM	194,496	1717D	198
1516/1 - 2 - 3	180	1580/8I	185	1639S	189	1692	194,496	1718A...M	198
1517	180	1580GL	185	1640	189	1692HS	256	1718A...P	198
1518/...	180	1585/5I - 6I - 7I	186	1640A	189	1694/L	194	1718A...Q	198
1520/1 - 1520/2	180	1585GI/5 - 6 - 7	186	1640K	189	1694A/L	194	1718A...R	198
1521/1 - 1521/2	180	1589PI/50 - 100 - 150	186	1640P	189	1694B/L	194	1718A...S5	198
1529	180	1589VI	186	1640Q	189	1695XS	195	1718A...T	198
1529/C7	180	1590	186	1640T	189	1696	195	1718D...M	198
1529PI	180	1591	186	1650	189	1696A	195	1718D...P	198
1530/C5	181	1593	186	1650FD	189	1696B	195	1718D...Q	198
1530/C16	181	1594	186	1650FT	190	1696D	195	1718D...R	198
1532	181	1595	186	1651DGT	190	1696S	195	1718D...S5	198
1533/...	181	1599B	186	1651DGT/IP	190	1699L	195	1718D...T	198
1533PR/1 - 2 - 3	181	1599F	186	1652	190	1699L/1	195	1719BA8	271
1534/...	181	1599G	187	1654	190	1699Q	195	1719BA12	271
1535/C...	181	1599P	186	1654DGT	190	1700N	195	1719BM/RL	200
1539	181	1599T	187	1656	190	1700N/PM	195	1719BM/RR	200
1540	182	1601/PC	187	1657DGT/2	190	1701BA	271	1719BMA...M	199
1542/1 - 1542/2	182	1602	187	1658/...	190	1701N	195	1719BMA...P	199
1544/...	182	1602/C9	187	1658/C4	190	1701N/PM	195	1719BMA...Q	199
1545/C5M	182	1602A	187	1658DGT	191	1701NE/...	196	1719BMA...R	199
1547/C6	182	1602A-HS	256	1658SP/1	191	1701PMR	196	1719BMA...S5	200
1547KP	182	1602BA	271	1659	191	1702N	196	1719BMA...T	199
1547P	182	1603	187	1662/1 - 1662/2	191	1702N/PM	196	1719BMB/P	200
1547PC/2	182	1603A	187	1662AN	191	1702PMR	196	1719BMC	200
1547PL/2	182	1603B	187	1662DGT/A	191	1703BA/A	271	1719BMD...M	199
1548/C8	182	1603BK	495	1662SP0	191	1703BA/P	271	1719BMD...P	199
1549	182	1603K	495	1662SP2	191	1703BA/PL	271	1719BMD...Q	198
1550U	183	1604	187	1666	191	1704	196	1719BMD...R	199
1550U/CGS-R	183	1604/C9	187	1666A	191	1704A	196	1719BMD...S5	199
1550U/M	183	1605	188	1668	192	1704C	196	1719BMD...T	199
1550U/MRC-ABE	183	1606	188	1668A	192	1705	196	1719BMR	200
1550U/MRC-C	183	1606A	188	1670	192	1705PT	196	1719BMX...M	199
1550U/S...	183	1606A/C9	188	1670A	192	1706DGT	196	1719BMX...P	199
1550U/SS187	183	1606T	188	1672	192	1707	196	1719BMX...Q	199
1555C	183	1607	188	1672A	192	1707A/1 - 2 - 3	196	1719BMX...R	199
1555Q	183		188	1674A	192	1708/8 - 13 - 20	197	1719BMX...S5	200

ALPHANUMERIC INDEX

1719BMX...T	199	1748-BX	483	1760DGT	207	1778SCL	213	1839/R2	217
1719R/...	200	1748N	482	1760DGT-R3	209	1778SOS	213	1839/R3	217
1720/...	200	1748-N2D	482	1760/IR500	209	1778SOS-HS	257	1840BM	218
1720/B	200	1748-NA1	484	1760/IR1000	210	1778U	213	1842LED/ABM	218
1720D/...	200	1748-NA2	484	1760/IR1600	210	1778V18	213	1843BM	218
1720D/B	200	1748-NL	483	1760K	209,496	1778W	213	1843R/BM	218
1720/S	200	1748-S	485	1760/OHM	208	1778X	213	1846LED/ABM	218
1721/B6	200	1748-SC	485	1760PA/80	208	1781	213	1846LED/BM	218
1723	200	1748-ST	485	1760PA/AC	208	1783	213,496	1846R-LED/BM	218
1725	200	1748-UL	482	1760PA/AC-DC	208	1784	213	1848	218
1725CR	201	1749	203	1760PT	209	1784BA	271	1850B	218
1725MQ	250	1749A	204	1760/RMS	208	1800/100	213	1850C	219
1726	201	1749AC	204	1760/RSE	209	1808	213	1850U...	219
1726BM	201	1749A/RB	204	1760/TC2	209	1812 150	214	1851VK	219
1727	201	1749A/RT	204	1760R/TC2	209	1814M	214	1851VK-12C	219
1727BA	271	1750	204	1761	210	1820	214,497	1851VK-12V	219
1727BM	201	1750CG	204	1761RS/1	210	1820 60	214,497	1852R1750	219
1727HS	256	1750HS	256	1762	210	1820 80	214,497	1852S-F	219
1728...	201	1750KG10	204	1762K	496	1822	214,497	1852S-FLESS	219
1728BA	271	1750M	204	1763	210	1822 180	214,497	1852S-L	219
1729	201	1750R/1 - 1750R/2	204	1763G/S500	210	1822 320	214,497	1852S-PIATTE	219
1729CG	201,496	1750RC	204	1765/C24	210	1823 60	214	1860 140A	220
1729DM 450	201,496	1750RP/1 - 1750RP/2	204	1766	210	1823R/60	214	1860 160A	220
1729LR	201	1750RT	204	1766/8	210	1824R	214	1860RC	220
1736A	201	1750TA	204	1766A	210	1825B	214	1860SQ	220
1737	201	1751	204	1766ER	211	1827	214	1870	220
1737AC	201	1751R	204	1766G	211	1827F	215	1870-20/5S	221
1737B	201	1752	205	1766I	211	1827/K	214	1870-72 /FC	221
1737BA	271	1752R	205	1766L	211	1827PC	214	1870-72/FL	222
1737NX	201	1753	205	1766LI	211	1827PCL	214	1871M	221
1738	201	1753R	205	1766T	211	1827PFL	214	1871M/AS	221
1739B	202	1754	205	1767A	211	1830T	215	1872L	221
1740A	202	1755	205	1767PMC	211	1834L/USB	215	1872L 35/5S	222
1740B	202	1756	205	1767PMR	211	1834PL	215,497	1872L 35/FC	222
1741B	202,496	1756B	205	1770	211	1834PM	215,497	1873	221
1741B/C5	202	1756C	205	1770A	211	1834PS	215,497	1873 30/5S	222
1741BP	202	1756C-ZOR	205	1770BM	211,496	1834PXL	215,497	1874	221
1741RV...K	202	1756D	205	1770RL	211	1834RB-L/USB	215	1874 50/5S	222
1741U	202,496	1756D-ZOR	205	1771	211,496	1834RR	215,497	1874 50/FC	222
1742	202	1756G	205	1771BM	211,496	1835/1	215	1877	222
1742A	203	1757	206	1771HD	212,496	1835/2	215	1877A	222
1742A/C	203	1757A	206	1771RL	212	1836A	216,497	1878 3	222
1742A/KR	203	1758	206	1772H	212	1836B	497	1878 11	222
1742/C4	203	1758A	206	1772H-HS	257	1837N	216,497	1878 30	222
1742KR	203	1758B	206	1772M	212	1837PLUS	216	1879	223
1742R-A/M...	203	1758BA	271	1772R	212,496	1837/USB	216	1879 6	223
1742R-AL/M...	203	1758LG	206	1772RL/2	212	1837RB/USB	216	1879R/K4	223
1743	203	1758M	206	1773A	212,496	1838/11LED	216	1880	223
1743HS	256	1758R	206	1773RL	212	1838COB	217,497	1880ADB	223
1743T	203	1758VT	206	1774	212	1838FLASH	217	1881	223
1748-BA1	484	1758VT/L	206	1774A	212	1838P	217,497	1882	223
1748-BA2	484	1759	207	1774A/RL	212	1838RA/10-11LED	216	1883	223
1748-BH	483	1759A	207	1776BA	271	1838RB/10LED	216	1883NC	223
1748-BL	483	1759B	207	1777BM	212	1838RB/FLASH	217	1884	223
1748-BP	484	1759HD/3	207	1777BMT	212,496	1838RR/11LED	216	1884/C12	224
1748-BR	483	1759HD/RR	207	1777MQ/C	250	1838RV/11LED	216	1885	224
1748-BT	484	1759HD/TRUCK	207	1777MQ/U	250	1838SL	217	1885/C1	224
1748-BT2	484	1759TT	207	1777RL/U	250	1838SLR	217,497	1885/C1-R1	224
1748-BT3	484	1760B	208	1777T	212,496	1838SN	217,497	1885/C1-R2	224
1748-BV0	483	1760BHS	256	1778CM	212	1838UV	217	1885/C1-R3	224
1748-BV2	482			1778D	213	1839/R1	217	1885/C1-R4	224

ALPHANUMERIC INDEX

1885/C1-R5	225	1918	292	1935F	282	1949F	289	11131	474
1885/C1-R6	225	1919F1/2	293	1936/4A	282	1949G	290	11132	474
1885/C1-R7	225	1919F1/4	292	1936/5A	282	1949GPE	290	11135	474
1885/C1-R8	225	1919F3/8	293	1936/7A	282	1949GPN	290	11140	474
1885/C2	225	1919FE1/4	292	1937	282	1949M	290	11141	474
1885/C2-R1	225	1919L	293	1937 2,5	282	1949T	289	11145	474
1885/C2-R2	225	1919ML	293	1937C	283	1949U5	289	11150	474
1885/C2-R3	225	1919RB-F	293	1937K...	283	1949U5/A	289	11151	474
1885/C2-R4	225	1919RB-FE1/4	292	1937KC	283	1949U5/B	289	11155	474
1885/C2-R5	225	1919RF-F	293	1937KL	283	1949U5/C	289	11200A	474
1885/C2-R6	225	1919RF-FE1/4	292	1937KL-D	283	1949U5/D	289	11200B	474
1885/C2-R7	225	1919RM-F	293	1937M	284	1949U5/E	289	11202A	474
1885/C3	225	1919RM-FE1/4	292	1937M-01÷11	284	1951	290	11202B	474
1885/C3-R1	225	1919SC	293	1937N10	284	1972/12	272	11202C	474
1885/C3-R2	225	1921B1	275	1937N10-GR	284	1972/18	272	11204A	475
1885/C3-R3	225	1921M1	275	1937N20	284	1982/12EF	273	11204B	475
1885/C3-R4	226	1921M2	275	1937N20-GR	284	1984/18QM	273	11204C	475
1885/C3-R5	226	1921N3	275	1937R/P	282	1995MQ/G1 - G2	250	11208A	475
1885/C3-R6	226	1922P1	275	1937RT	283	1995MQ/T	250	11208B	475
1885/C3-R7	226	1922P2	275	1937RT/R	283	11001	471	11210A	475
1885/C3-R8	226	1922P3	275	1937RT/T	283	11001H	471	11210B	475
1885/C3-R9	226	1924B	276	1938	284	11003	471	11210C	475
1885/C3-R10	226	1924CD	276	1938R/L	284	11011	471	11212A	475
1889	224	1924F	275	1938R/S5	284	11011H	471	11212B	475
1889CF	224	1927AN	277	1940	285	11018	471	11214A	475
1893/1234YF	226	1927B	276	1940/S5	285	11019	471	11214B	475
1893/134A	226	1927CD	276	1940E10	285	11021	471	11214C	475
1893TR/1234YF	226	1927G	277	1940E10/MT	285	11022	471	11216A	475
1893TR/134A	226	1927P	276	1940E10/S...	285	11023	471	11216B	475
1893TR/CI	227	1927SP-AM	277	1940E10/S5	285	11024	471	11216C	475
1895 6	227	1927XM	276	1940MT	285	11031	471	11218A	475
1895 13	227	1928CD	277	1940S...	285	11032	471	11218B	475
1895 27	227	1928DA	277	1942A	286	11033	471	11220A	476
1895G	227	1928DAL	277	1942LR	286	11034	472	11220B	476
1895/S	227	1928K4	278	1944A	286	11035	472	11220C	476
1897	227	1928XM	277	1944AR 2	286	11036	472	11222	476
1897/CRB	228	1930A	278	1944N	286	11037	472	11230A	476
1897/G	228	1930CD	278	1944PA	286	11038	472	11230B	476
1897/KSA	228	1930HLA	279	1945C	286	11040	472	11230C	476
1897/MV	228	1930LA	278	1945C/G...	287	11045	472	11232A	476
1901BM/8	290	1930LH	278	1945C/GP...	287	11046	472	11232B	476
1901T/10	290	1930PA	278	1945P	287	11047	472	11234A	476
1910/8 - 1910/10	291	1930ZL	279	1945P/S...	287	11048	472	11234B	476
1914	291	1931AN10	279	1945S	286	11049	472	11240A	476
1915B	291	1931CD6	279	1945S/G...	286	11050	472	11240B	476
1915C	291	1931CD10	279	1946C4,8	287	11050S	472	11242A	476
1915C/L	291	1931CD13	279	1946C7,8	287	11069	472	11242B	476
1915D	291	1932B10	280	1946C/T...	287	11100	472	11246A	476
1915E	291	1932B13	280	1946KF	288	11101	472	11246B	476
1915E/XL	291	1932RS13	280	1946KF/M...	288	11102	473	11248A	477
1916G	291	1933	280	1946T	287	11105	473	11248B	477
1916GF	291	1933AN90	281	1947	288	11106	473	11259	477
1916I	291	1933AN90-H	280	1947G	288	11107	473	11260	477
1916JF	292	1933I	281	1947H	288	11110	473	11263	477
1916JM	291	1933IH	280	1947M	288	11111	473	11264	477
1916R	292	1933IL	281	1947M -...	288	11115	473	11265	477
1917F	292	1933ILH	280	1948	288	11116	473	11266	477
1917JF	292	1933L	281	1948PR	289	11120	473	11268	477
1917JM	292	1934BV	281	1949BC	289	11121	473	11300A	477
1917M	292	1934MAV	281	1949BC/RU	289	11125	473	11300B	477
1917RG	292	1934MAV70	281	1949DGT	290	11130	473	11300C	478

ALPHANUMERIC INDEX

11300D	478	2115P L-MQ32	248,300	330R/A	39	365	43	3026/R 1,0	232
11300E	478	2200-COVER0 C22S	333	330R/I	39	365R/...	43	3026/S	232
11300F	478	2250-O	228	331L	39	366	43	3026/SP	232
11300G	478	2251-O	228	331LR/L	39	374	43	3027 10	232
11310A	478	2252	228	332	39	374K	488	3027 20	232
11310B	478	2252KR4	228	334	39	374R/...	44	3027 30	232
11310C	478	2254C	228	334R	39	375	43	3027 50	233
11310D	478	2254F	228	334R/I	39	376	43	3027/KP	233
11310E	478	2254SV	228	336	39	378	43	3027/KPP50	233
11310F	478	2254T	229	338	39	378BA	266	3027/PR	233
11310G	478	2258-O	228	338R	40	383	44	3029/2T	233
11320	478	2300-COVER C23S	333	338R/I	40	383R	44	3029/2T-L/R5	233
11411	478	2300-COVER C23ST	333	338RP	40	384	44	3029/2T-L/R6	233
11415A	478	2300ST/KIT	305	339A	40	384RC	44	3029/2T-L/RP	233
11415B	478	2400-COVER C24S	333	339A/R	40	386A	44	3029L/2T	233
11420A	478	2400-COVER C24SA-XL	333	340	40	386A/RC	44	3030/2T	233
11420B	478	2400S/PF	316	340RL	40	386BA	267	3030/2T-R5	233
11431	479	2499PC	316	341	40	388	44	3030/2T-R6	234
11435	479	2499PF	316	341B	40	388A	44	3030/2TRP	234
11440A	479	2499PF/M	316	341B/RL	40	388C/C8	44	3033/3T	234
11440B	479	2499R/PC	316	341B/RM	40	392C	44	3035	234
11440C	479	2499S-R/PC	316	341RL	40	392RG/C	44	3036	234
11450A	479			342	40	393	44	3040C	237
11450B	479	3		342A	41	395	44	3040C/S1	237
11450C	479			342A/MOL	41	395T	45	3040C/S2	237
11480	479	30	23	342A/RL	41	399	45	3041C	237
11491	479	30BA	264	342MOL	40	399R/...	45	3041C/12	237
11493	479	31	23	342P	41	3000M/LT	229	3041C/16	237
11495	479	31BA	264	342P/RL	41	3000M/RLS	229	3042C	237
11496	479	31BM	23	342RL	40	3000S/PLM	321	3043C	237
11498	479	31BM/D6	23	345	41	3002	229	3043C/ 41÷47	237
		2		345C	41	3002/RLS	229	3047C	237
2001/B26	295	31L	23	345SB	41	3003	229	3048C	237
2001/BV	295	31SE	23	345SB/R	41	3003/RLS	229	3050/600	238
2005PA/D	295	32	23	345U	41	3006	229	3050/CC	237
2005PA/S	295	32AU	23	349	41	3007	229	3050/KA	238
2009ID	295	32AUR	23	349/SMAS	41	3008	229	3050/LA	238
2009N/BV	295	32BA	264	349/SMM	41	3009	229	3050/MS	238
2028E	295	34	23	350	41	3009R/GR4	230	3054	238
2028/VV	295	34BA	264	351C	41	3010H	230	3055M	238
2029/RT	295	34INOX	259	351P	42	3010/T...	230	3057	238
2029/VV	295	35	23	352C/U	42	3010V	230	3061/2T	234
2029E	295	35HS	252	352U	42	3011/T	230	3061 /2T-P50	234
2032/TE	296	35PM	23	353N	42	3012	230	3061 /2T-P100	234
2032/TV	296	35PMR	23	353N/C6	42	3012C	230	3065/20-10T	235
2033E	296	36	24	353NM	42	3012I	231	3065/40-20T	235
2033P/VV	296	37	24	355	42	3014	231	3067/60-15T	235
2036E	296	37PM	24	357 F3	42	3014R/GR5	231	3067/70-13T	235
2036/TV	296	37PMR	24	357 R/F3	42	3014SAR	231	3070B	238
2037/TV	296	38/DS1	499	358	42	3014SAR/1	231	3073	238
2038/TV	296	38/DS2	499	358RL	42	3014SAR/2	231	3075/CM	239
2041UC	297	39BA	264	359	42	3014SAR/RR	231	3075/K10	239
2051N	297	39INOX	259	359CH	43	3025	231	3075A	238
2055HB	297	310	38	360	43	3025/PF	231	3075B 55	239
2060/VV	297	310B	38	360HS	253	3025/RF	231	3075MV 56	239
2080/V6	297	310C/4	39	360R/...	43	3025/RG	231	3079/21	239
2080/V6-U	297	310C/8	39	362	43	3026 0,3	231	3080/C15	239
2080/V12	297	311	39	362R/...	43	3026 0,5	232	3080R/CS3	239
2080 /V12-S	297	330	39	363	43	3026 1,0	232	3081	239
		330BA	266	363BA	266	3026/R0,3	231	3085	239
		330BA/2R	266	363R/...	43	3026/R0,5	232	3091	239

ALPHANUMERIC INDEX

3092	239	42BA	264	426MD/S	50	444	55	588	61
3093/E	239	42BA-AS	264	426MD/SP10	50	444G	55	590 - 592	61
3093/U	239	42HS	252	426MD/T	50	446ASC/C37	57	594	62
3500/D	323	42HS-AS	252	426MD/TA	50	446ASF/C29	56	596 - 598	62
3500/P	323	42INOX	259	426MD-3/A9	50	446ASG/C23	57	599DGT	62
3700-COVER C37	333	42INOX/S	259	426MD-3/CP3	49	446ASW/C36	56	599DGT-AN	62
3700/PC	327	42INOX/SC9	259	426MD-3/CT3	49	446/C30	56	5700LAMP	344
3700/PF	327	42INOX-AS	259	426MD-3/F3	49	446/C48	56	5902MT	420
3700/PFL	327	42INOX-AS/S	259	426MD-3/FA3	49	446/C110	56	5902MT/AS	421
3700/PLA	327	42K	487	426MD-3/OG3	49	447/C37	57	5902VI	382
3700/PLL	327	42LMP	25	426MD-3/OV3	50	447/C53	57	5904VG/1M	422
3912P	241	42LMP/S	25	426MD-3/S3	50	447/C70	57	5904VG/2M	423
3912T	241	42MP	25	426MD-3/T3	50	450	57	5904VG/2T	424
3916MM	241	42SLIM	25	426MD-3/TA3	50	450AD	58	5904VG/3	425
3921	241	42SLIM/S11	25	426SB	49	450AL	58	5904VG/3T	426
3923	241	42/SC9I-E	24	426SB/SP	49	450/C9	58	5904VG/5T	427
3927	241	42/SP25	24	427	51	450/C13	58	5904VI/1T	383
3932U	241	45	26	428/C14	51	450/C15	58	5904VI/2T	384
3935	241	410	45	428FC	51	450/C21	59	5904VI/3T	385
3937	241	410A	45	428FP	51	450PA/1	58	5904VU/1M	393
3948	241	410AS	45	429/C14	51	450PA/2	58	5904VU/2M	394
3952	241	410AS/SEL	46	429FC	51	450PR	58	5904VU/2T	395
3952/S7	241	410AS/SP	46	429FP	51	451	59	5904VU/3T	396
3953	242	410MIX/SEL19	45	430	51	451GA	59	5905VG/1	428
3955	242	410/SEL	45	430/SP	51	451PA	59	5905VG/2	429
3961 3,2	242	410/SP	45	430ASC	52	451PR	59	5908VG/2T	430
3961 3,3	242	412	46	430ASW	52	452	59	5908VI/2T	386
3961 3,5	242	412/C150	46	431	52	452GA	59	5910VG/3T	432
3961U	242	412/SP	46	431/SP	52	4100-COVER C41H	333	5910VI/3	387
3962MV	242	412/SP91	46	433	52			5910VI/3T	388
3962SH	242	412A	46	433ASF	52			5914VU/M	397
3963P	242	412L	46	433ASG	52			5915VU/0	398
3964	242	414	47	434	52	52	26	5915VU/1	399
3965	242	414/C116	47	435	53	52MQ	246	5915VU/2	400
3965C	242	414/SP	47	435G	53	53	26	5915VU/3	401
3967	242	415	47	436	53	55	26	5915VU/4	402
3969	242	415/C116	47	436L	53	55AS	27	5915VU/5	403
3969K3	242	415/SP	47	436R	53	55BA	264	5915VU/AS	404
3971	242	415/SP91	47	437C	53	55BA-AS	265	5927VU/M	405
3972	243	416	48	437C/...	53	55HS	252	5935ET/1MB	413
3973/1	243	416/SP19	48	437C/RM14	53	55K	487	5935VG/1MB	432
3973/2	243	417	48	437K/16	53	55MP	27	5935VI/1MB	389
3973/3	243	417/SP	48	437K/33	53	58	27	5935VI/2MB	390
3973/4	243	419	48	437K/8	53	58BA	265	5935VU/1MB	406
3973PF	243	421	48	437U/09	54	58BA-AS	265	5938U/2T	407
3975	243	421/SP6	48	437U/E-M...	54	560/C2	59	5940SBK	433
3984/1	243	422	48	437U/PM	54	560/C4+	60	5941KART	436
3984/2	243	423	48	438...	54	560/C6	60	5941VU-M	434
3984/3	243	423A	49	438A	54	560/C12	60	5945VUM	435
3984/4	243	424	49	440	54	561/1	60	5954VG	437
3984/5	243	424/SP	49	440A	54	562/1 - 562/2	60	5954VI	391
3984/6	243	425	49	440ASC	54	564/3R - 564/4R	60	5957U-P	408
3991	243	425/SP	49	440ASF	55	565/1R - 565/2R - 565/3R	60	5957VG	438
3992	243	426	49	440ASG	55	565/4R	61	5957VI	392
		426/SP	49	440ASW	54	565/5R	61	5958U	409
		426MD/CP	50	440B	54	567/4R	61	5980/MQ	416
		426MD/CT	50	441	55	567/5R	61	5980EL/A	417
42	24	426MD/F	50	441A	55	581	61	5980EL/B	418
42AS	25	426MD/FA	50	441B	55	583	61	5980ET/A	414
42AS/B	25	426MD/OG	50	442	55	583/C31	61	5980ET/B	415
42AS/S	25	426MD/OV	50	443	55			5980ID	419

ALPHANUMERIC INDEX

5980U/BIKE	410	78	28	729/16	74	7243CR	515	7577N	540
5988ROAD/7M	411	78AS	28	729/21	74	7243EN	513	7579T	540
5988U6/M	412	78BA	265	729/22	74	7243FT	516	7622G	539
6		78BA-AS	265	729/25	74	7245BK	516	7632G	539
600/1 - 600/2	63	710	68	729L	73	7246BK	516	7634G	539
601C	63	710/16	68	729LS	73	7246E	513	7635G	540
601CA	63	710/20	68	729/OR... - 729/SP...	74	7247BK	516	7635N	539
603	63	710/21	68	729T	74	7248GK	525	7636BL	540
604B	63	710/25	69	730	74	7249GK	525	7683	540
605E	63	710/C10	69	730/15	74	7252NKK	526	7684	540
606MQ/25	246	710/OR... - 710/SP...	69	733/15	74	7253NKK	526	7685	540
606MQ/50	246	720	69	7041LCD/4S	220	727PI/16	71	7734	540
611	63	720/15	71	7041LCD/4S-VE	220	727PI/22	72	7780T	540
612 ÷ 614	63	720/16	71	7041LCD/4S-VI	220	727PI/32	72	7800G	547
614/50	63	720/20	71	7042LCD	220	7290NA	531	7810	537
615	64	720/21	71	7042LCD/RV	220	7291NA	532	7811	537
616 - 617 - 619	64	720/25	71	7042LCD/RV-INT	220	7293HM	533	7812	537
621	64	720AS	69	7051MP	548	7293HN	533	7813	538
641	64	720/C6	71	7061TC	548	7294HM	534	7816BL	538
642	64	720/C12	71	7076BC	548	7294HMC	534	7816G	538
643	64	720FTX	70	7076BD	548	7294HN	534	7820	545
652	64	720FTX/SB	70	7076BP	548	7300FT	532	7821	545
653	64	720IC	70	7076BU	548	7300MK	532	7823	545
659/15	65	720L	69	7093BC	548	7310CRK	523	7825	545
659/16	65	720L/S3	69	7093BD	548	7313B	526	7829	545
665	65	720LC	69	7104 90	548	7313G	527	7830ST (ex 7816ST)	544
665LB	65	720LC/C3	69	7105 6	548	7314AB	527	7831ST	544
665SW	65	720LC/S5	69	7109A	548	7314AF	527	7833ST	544
666HS	253	720LCL	70	7109D	548	7315AN	528	7835ST	544
666N	65	720LCL/C3	70	7195A	548	7316N	527	7840BL	541
666N LBF.IN	66	720LS	69	7200BKK	522	7318AN	528	7849BL	541
667N	66	720ME	70	7201BKK	522	7319ESD	532	7860E	541
668N	66	720ME/C8	71	7210BKK	522	7328EA	517	7861E	541
668RG	66	720MRC	70	7210PB	523	7328EN	517	7863E	541
669N	66	720/OR... - 720/SP...	71	7211PG	523	7340B	530	7865E	541
671B/C5	67	720TC	70	7212FG	519	7340R	530	7867E	542
671B/C10	67	720TC/S5	70	7212LG	519	7341N	530	7869E	542
671N/C10	67	720TX	70	7213FG	519	7349RP	531	7870E	542
671N/C20	67	720TX/C6	70	7214FN	520	7350RP	531	7871E	542
671N/C30	67	727/C16	72	7214LN	520	7352A	528	7873E	542
677	67	727/ES16	71	7215FN	520	7352B	529	7875E	542
677/C	67	727/ES16TX	71	7216BKK	523	7353Y	529	7877E	543
677/CP200	67	727/ES22	72	7217FB	520	7354N	529	7879E	543
677/CV - 678/CV	68	727/ES22TX	72	7217FG	521	7355V	529	7880SC	538
678/C	68	727/ES32	72	7218FN	521	7398EF	535	7900E	543
680	68	728	72	7219FY	521	7398GEL	535	7901E	543
682	68	728/15	73	7220PEK	517	7398U	535	7903E	543
6200AP/S10	549	728/16	73	7221PEK	518	7399A/N...	535	7904E	544
6600 E/...A10÷K20	510÷511	728/21	73	7223PEK	518	7421	535	7905E	543
6600 M/...11÷881	504÷509	728/22	73	7224PEK	518	7423	535	7907E	544
6800 VE	503	728/25	73	7235BK	524	7425	535	7909E	544
6888	503	728AS	72	7236BK	524	7427	535	7930G	545
6888B1/2	497	728/C10	73	7237WR	525	7429	535	7931G	546
6888B1/4	497	728/C20	73	7238WR	525	7525	537	7933G	546
6888B3/8	497	728/OR - 728/SP	73	7239C	514	7526	537	7935G	546
7		728FTX	72	7241BK	514	7546BL	538	7939G	546
73	27	728L	72	7241CK	514	7546G	538	7970	546
		728LQ	73	7241EN	513	7546N	539	7971L	546
		728LS	72	7241FT	515	7548BL	539	7978L	547
		729	73	7243BK	515	7548G	539	7979	547
		729/15	74	7243CK	515	7548N	539		

ALPHANUMERIC INDEX

7980N	547	862TX	79	8010Z	554	8080	561	8182S	574
7980R	547	862TX/L	79	8010Z-K	583	8082	561	8182T	574
7984G	547	862TX-XL	79	8016	555	8083	561	8182TS	574
7985	547	866LP	79	8016DA	556	8085	566	8185	575
7991N	547	866PE	79	8016FR	556	8086	566	8186	575
7992N	547	866PH	79	8016FR-K	583	8090	566	8187	575
8		866PZ	79	8016-K	583	8090F	566	8188C	576
		866RTX	79	8016U2	555	8091	567	8188CG/25	576
		866TX	79	8016U-K	583	8091SL	567	8188CU/25	576
80	28	867I...	80	8018E	556	8092	567	8188F	575
83	28	867/C20	80	8018T	556	8092SL	568	8188VF/35	575
83AS	28	867/C38	81	8020	556	8094	568	8188VFG2	576
83AS/S	28	867/C52	81	8021	556	8094SL	568	8189	576
88	28	867PE	80	8025	557	8096	569	8189PA	576
88/S7	28	867PE/L	80	8025-K	583	8096SL	569	8201T	576
89BA	265	867RIBE	80	8026A	557	8097	569	8205	576
89MQ	246	867RIBE/L	80	8026A-K	583	8097SL	570	8206	577
850MQ	246,488	867RTX	80	8026R	557	8098	570	8207	577
851	74	867RTX/L	80	8026R-K	583	8098SL	570	8209	577
851SR	74	867TX	80	8028	557	8100	566	8210	577
852	74	867TX/L	80	8028-K	583	8105	555	8216	577
855P	75,488	867XZN	80	8029R	558	8105-K	583	8216-K	584
860/55	75	867XZN/L	80	8029R-K	584	8109	555	8220	577
860/58	75	882	81	8031R	558	8109-K	583	8225	577
860/58K	488	882AN	81	8031R-K	584	8110	555	8227	578
860/C27	76,489	882M	81	8032	558	8114	561	8228	578
860/C38P	76	882M1	81	8032-K	584	8116	561	8240	578
860LP	75,488	882MSR	81	8040EN	559	8120	561	8240F	578
860MIX/A10	76,489	882P	81	8040EN-K	584	8120B	562	8242	578
860MIX/A31	76,489	892	81	8040EZ	558	8129	562	8242F	578
860PE	75,489	895	82	8040EZ-K	584	8130	562	8248	578
860PE/A10	76	897	82	8041	560	8130A	562	8249	579
860PH	75,488	897L	82	8041-K	584	8131DL	562	8249G	579
860PHZ/A10	76	8001TZ	552	8042EN	559	8131Z	562	8250	579
860PZ	75,488	8001TZ-K	582	8042EN-K	584	8139DL	562	8264	579
860RTX	75,489	8001Z	552	8042EZ	559	8139Z	562	8267	579
860TX	75,489	8001Z-K	582	8042EZ-K	584	8139ZCH	562	8272	579
860TX/A10	76,489	8002ZD	552	8043	560	8150	571	8273	579
861/C61P	78	8002ZS	552	8043-K	584	8153	571	8274	580
861LP	77	8003ZD	553	8044	560	8156	571	8274A	580
861PE	77	8003ZS	553	8048	560	8157	571	8274G	580
861PH	77	8004ND	552	8049	560	8158	571	8276	580
861PH/C	77	8004NS	552	8050 D1+D45	565	8159	572	8276G	580
861PZ	77	8005TZ	553	8051S	563	8160	572	8278	580
861PZ/C	77	8005TZ-K	582	8051S-K	584	8161	572	8280	581
861RIBE	77	8005Z	553	8052	564	8166	573	8282	581
861RTX	77	8005Z^	582	8057	564	8170	572	8282S	581
861SP	78	8006Z	553	8057R	564	8173	572	8284	581
861TQS	78	8006Z-K	582	8058R	564	8176	572	8285	581
861TRW	77	8007Z	554	8058R/PS	565	8177	573	8286	581
861TX	77	8007Z-K	582	8060R	564	8178	573	8287	581
861TX/C	77	8008N	554	8060R/PS	565	8179A	573	8290	581
861XZN	78	8008N-K	583	8061F	564	8179B	573	8293	582
862F	79	8008TZN	554	8061R	564	8179M	573	8297C	582
862F/A7	79,489	8009FD	553	8062	564	8180	574	8297F	582
862LP	78	8009FS	553	8063	565	8181	574	8302Z	562
862PE	78	8009TZ	554	8064S	565	8181S	574	8303Z	562
862PH	78	8009TZ-K	583	8065SC	565	8182	574	8317DZ	556
862PH/L	78	8009Z	554	8074	560	8182A	575	8317SZ	556
862PH-XL	78	8009Z-K	583	8074A	561	8182E	575	8381SL	563
862PZ	78	8010TZ	554	8074G	561	8182H	574	8381SP	563

ALPHANUMERIC INDEX

8381SX	581	93K	487	96TINOX/S5	260	900T/44	84	910B	87
8383C	563	94	30	96TINOX-AS	260	900TX	83	910B/C10	91
8383P	563	94K	487	96TINOX AS/S7	260	900TX/SB	83	910B/C16	91
8515CH	563	95	30	96TK	488	900/25K	489	910B/C16Q	91
8515V	563	95BA	266	97BTX	34	900/32	84	910B/C29	91
8515Z	563	95FTX	30	97BTX/B	34	900/35A	84	910B/SB	87
8531	557	95FTX/S	30	97BTX/SC8	34,488	900/40	84	910B/SN	87
8532	557	96	30	97BTXL	34	900/42	84	910BL	87
8535	563	96/SC9	30,487	97BTXL/SC8	34,488	900/55	84	910BL/SB	87
8600 E/R1	510	96/SC12	30	97RTX	34	900/55K	489	910BP	89
8600 E/R2	510	96/ST	30	97RTX/B	35	900/58	85	910BP/SB6L	89
8600R/11	509	96/ST6K	487	97RTX/SC8	35	900/58K	489	910CF	89
8600 R/12	509	96AS	31	97TTX	35	900/C11	85	910CF/SB	89
8600 R/13	509	96AS/B	32	97TTX-HS	253	900/C11HR	86	910E-HS/55	253
8600 R/113	509	96AS/BG7	31	97TX	34	900/C13-5	85	910FTX	88
8600 R/114	510	96AS/G	31	97TX/B	34	900/C13-8	85	910FTX/L	88
8600 R/225	510	96AS/SC9	31	97TX/BG8	34	900/C24	86	910FTX/LSB	88
8600 R/412	510	96AS/T	31	97TX/G	34	900/C39	85	910FTX/SB	88
8600 R/511	510	96BA	266	97TX/SC8	34	900/R55	103	910LP	88
8600 R/601	510	96BA/BP	266	97TX/ST	34	900/SB	82	910M/35	90
8600 R/611	510	96BAF-AS	266	98XZN	35	902R/C6	86	910M/55	90
8871	257	96/BG7	30,488	98XZN/B	35	910/15	89	910M/56	90
8872A	257	96/BGS7	30,487	99	35	910/16	89	910M/R55	103
8872AS	257	96BP	32	99BA	266	910/20 - 910/21 -	89	910ME	89
8873	257	96BP/AS	33	99SQ	35	910/22		910ME/SB	89
8877	257	96BP/ASB	33	99ST	35	910/21K	489	910MQ/21	247
8877M	257	96BP/AS-SC9	33	99 VN/...	35	910/25	90	910MQ/22	247
8879	257	96BP/SC9	32	900	82	910/25K	490	910MQ/55	247
8880	257	96BPA	33	900AN	84	910/36A	90	910MQ/B	246
8883	257	96BPA/SC9	33,487	900AS	82	910/40	90	910MQ/C16	247
8889C1	464	96BPC	32	900AS/C10	86	910/42	90	910MQ/PE	246
8889C2	464	96BPC/SC9	32,487	900AS/C17-MBM	86	910/46	90	910MQ/PT	246
8889C3	464	96BPINOX	259	900AS/L	83	910/55	90	910MQ/T	247
8889C4	464	96BPINOX-AS	259	900AS/MB	82	910/55K	490	910MQ/TX	246
8889C6	464	96BPINOX-AS/B8	259	900AS/MB-C17	86	910/55Q	90	910MQ/XZN	246
8889CD	464	96C/AS	31,487	900AS/MBL	83	910/58	90	910PE	88
8889CS	464	96C-AS/SC9	31	900AS/SB11	82	910/58K	490	910PE/SB	88
8889P1	463	96INOXBP/B	259	900BG/30	84	910/R55	103	910PH	88
8889P2	464	96L	32	900BG/30C	84	910/R55Q	103	910PH/SB4	88
8889P3	464	96L/SC12	32	900BG/30K	489	910/R55X	103	910PT	89
8889P4	464	96L/SC8	32	900E-HS/55	253	910A	87	910PT/SB	89
8889PD	464	96LBP	32	900FL	84	910A/AS	87	910TX	89
8889PS	464	96LBP/SC9	33,487	900FTX	83	910A/C10	90	910TX/SB	89
		96LC	32	900FTX/SB9	83	910A/C16	91	920/15	96
		96LC/SC8	32	900K	489	910A/C16HR	92	920/16	96
		96LC/SC12	32	900L	82	910A/C16Q	91	920/20 - 920/21 -	96
90	29	96N	31	900L/SB13	82	910A/C17	91	920/22 - 920/23	
90AS	29	96N/SC9	31	900LP	83	910A/C29	91	920/21K	490
90BA	265	96N/SC12	31	900M/35	84	910A/SB	87	920/25	96
90K	487	96N/ST	31	900M/55	84	910A-AS/SB13	87	920/25K	490
91	29	96N/ST6K	487	900M/R55	103	910AK	489	920/35A	96
91BA	265	96T	33	900MB	82	910AL	87	920/36A	96
91HS	252	96T/AS	33	900MB/C19	85	910AL/SB14	87	920/38	96
91HS-C	252	96T/S6	33	900MB/C28	86	910AN	90	920/40	96
92	29	96T/S11	33	900MB/L	82	910AS	88	920/42	96
92BA	266	96TAS/S	33	900MB/SB	82	910AS/C13	91	920/44	96
92HS	252	96TBP	34	900ME	83	910AS/L	88	920/46	96
93	29	96TBP/S6	34	900ME/SB8	83	910AS/MBM-C18	92	920/50	97
93BA	266	96THS	252	900PH	83	910AS/SB13	88	920/50F	97
93C	29	96THS-AS	252	900PH/SB4	83	910AS/SN	88	920/55	97
93HS	252	96TINOX	260	900PT	83	910ASL/SB12	88	920/55INOX	260

9

ALPHANUMERIC INDEX

920/55K	490	920ES/XL-SB	95	928/42	101	9516B	589	961D	112
920/55L	97	920FTX	93	928/55	102	951AS	106	961D/CF3,8	112
920/55LC	97	920FTX/C	93	928/R55	103	951AS/S	106	961D/DC5,5	112
920/55Q	97	920FTX/L	93	928/R55X	103	951BA	268	961D/DC8,5	112
920/55X	97	920FTX/LSB	93	928A	101	951K	490	961P6	112
920/56A	97	920FTX/SB	93	928A/C12	102	951MQ	248	961P6/S-2	112
920/58	97	920INOX-A	260	928AS	101	951TX	107	962	112
920/58K	490	920LH/SB7	94	928AS/C12	102	951TX/S	107	962M	112
920/C37	99	920LP	94	928B	101	952	107	962P	112
920/R50	103	920M/35	96	928B/C12	102	952AS	107	963	112
920/R55	103	920M/35L	96	928ME	101	952FTX	107	963BA	268
920/R55INOX	260	920M/55	97	929	102	952FTX/S	107	964	112
920/R55LC	103	920M/56	97	929/15	102	952L	107	964BA	268
920/R55Q	103	920M/R55	103	929/21 - 929/22	102	953	107	964BA/L	268
920/R55X	103	920ME	95	929/42	102	953/S	107	965	112
920A	92	920ME/C	95	929/55	102	953TX	108	965/S	112
920A/AS	93	920ME/SB	95	929/C8	102	953TX/S	108	965BA	268
920A/C11	98	920MQ/21	247	929/R55	103	955	108	966BA	268
920A/C12	98	920MQ/22	247	930	103	956C	108	966BA/V	268
920A/C12X	98	920MQ/55A	247	930/C	104	956E	108	966/C3	113
920A/C17HR	100	920MQ/A	247	930/S	103	956F	108	969/C5	113
920A/C20	98	920MQ/C16	248	932	104	956L	108	969B	113
920A/C20Q	98	920MQ/PE	247	932HS	253	957	108	970B	113
920A/C20X	98	920MQ/T	247	933	104	959	108	970C	113
920A/C21	98	920PE	94	933/S	104	959R	108	970EA	113
920A/C21X	99	920PE/AS	94	935	104	960	108	970EB	113
920A/C33	99	920PE/C	94	935/S	104	960/22EP	109	970OT	113
920A/SB13	92	920PE/SB	94	935K	490	960A	108	970Q	113
920A/SB8	92	920PE-AS/SB6	94	937	104	960AD/TP2	157	971/C8	114
920A-AS/SB11	93	920PH	94	937/S	104	960AVE	110	971TSP	113
920AK	490	920PH/SB4	94	937BA	268	960AVL	111	978 - 979	114
920AL	92	920RTX	95	937K	490	960BT	109	982	114
920AL/SB11	92	920RTX/SB	95	940	105	960BT/B	109	984	114
920AN	96	920TX	95	941	105	960/C6	109	985/B7	114
920AS	93	920TX/C	95	941/S	105	960CMB	110	985F	114
920AS/C10	100	920TX/C17	100	942BX	105	960CMB/R2	110	985M	114
920AS/C15	100	920TX/LSB4	95	942BX/DG	499	960CMD	110	986 48	114
920AS/C17X	100	920TX/SB	95	942BX/S	105	960CMD/R1	110	986 78	114
920AS/L	93	920XZN	95	943BX	105	960/D	109	986PT	114
920AS/MBM-C21	100	920XZN/LS	95	943BX/D	105	960 E-PI/P	110	987	114
920AS/SB11	93	920XZN/SB12	95	943BX/DG	499	960/P	110	987AR	115
920ASL/SB11	93	920XZN/SB7	95	943BXK	490	960EPC	110	987P	115
920B	92	921BA	267	943BX/S	105	960EPC/L	110	988/K4	115
920B/C11	98	921BA/21 - 921BA/22	267	943FL	105	960F	109	989	115
920B/C12	98	921BA/25	267	943FL/S	105	960G	109	989A	115
920B/C12X	98	921BA/42	267	943MQ	248	960H/C4	109	990	115
920B/C20	98	921BA/42	267	943MQ/BG	499	960KC-M8/M9/M10	110	991	115
920B/C20X	98	921BA/50	267	943MQ/S	248	960KPC	111	992	115
920B/C21	99	921BA/R50	267	944BX	105	960L	109	993	115
920B/C21X	99	921BA-AS	267	944BX/D	106	960M	109	993G	115
920B/C30Q	99	926BA	267	944BX/DG	499	960P	111	993MQ	248
920B/C33	99	926BA/22	267	944BX/S	105	960PI	111	993PL	115
920B/SB13	92	926BA/42	267	949	106	960PI/C19	111	994	115
920B/SB8	92	926BA/50	268	949/S6	106	960PI/S	111	994MQ	248
920BL	93	926BA/R50	268	950	106	960PMC	111	994PL	115
920BL/SB11	93	928/15	101	950/S	106	960RPI	111	994TF	115
920BP	94	928/16	101	951	106	960S	109	996	116
920BP/SB	94	928/20 - 928/21 - 928/22	101	951/S	106	960SL	109	998	116
920E-HS/55LC	253	928/25	101	951/SP	106	960SN	109	999	116
920ES	95	928/36A	101	9510	587	960UC	111	999A	116
920ES/SB	95			9515M	589	961BA	268	999B	116

ALPHANUMERIC INDEX

999/B	116	9563G	592	9851	468	C39/6 - 3900	330	C55B/GAA	355	
999C	116	9563P	592	9899C1/4	440	C39/7 - 3900	331	C55B/GAE	356	
999D	116	9569MS	593	C		C39/8 - 3900	332	C55B/GDS	355	
999E	116	9569P	593		C39MD	334	C55B/GE	355		
999G	116	9569S	593		C39SM	334	C55B PRO-4	354		
9500TL	586	9572MB	586		C04TSS-7	262,318	C39T	330	C55B PT/2	356
9501TL	586	9574B	588		C4 - 2104	298	C41H - 4100H	335	C55B PT/2,8	356
9502TL	586	9574O	588		C5 - 2105	298	C41H/CE	337	C55B/VS	357
9503TL	586	9577M	592		C6T - 2106	298	C41MS	337	C55C	368
9504TL	586	9579C	592		C7 - 2107	298	C41S - 4100S	335	C55C7	357
9505TL	586	9580S	587		C8 - 2108	298	C42H - 4200H	336	C55C8	358
9507D	586	9582LE	591		C9 - 2109	298	C42 MCH	337	C55CS	360
9507U	586	9586K	593	C10 - 2110	299	C42S - 4200S	336	C55KAI	367	
9508TL	587	9587 13x21	594	C10S - 2110S	299	C43	338	C55KAS	367	
9521	589	9587 9x14	594	C11	299	C45/AW	373	C55LMP/1	370	
9521OB	589	9588/10PI	594	C12 - 2112	299	C45/AX	373	C55LMP/2	371	
9524SC	591	9588M	593	C13	299	C45/BPW-1,3	375	C55M2	358	
9525/B	589	9588S/10...	594	C14	299	C45/BPW-2,0	376	C55M4	359	
9525BB	588	9589A/36	594	C16 - 2116	300	C45/BPX-1,3	375	C55M7	359	
9525/N	589	9589B/36	594	C18 - 2118	300	C45/BPX-2,0	375	C55M8	360	
9525BB	588	9590B	591	C19 - 2119 - C19L - 2119L	301	C45/BW	374	C55MA	361	
9525TL	588	9592B/C50	593	C20 - C20L - 2120	301	C45/BX	373	C55MDO	361	
9526P	592	9592B/P	593	C20TSS	261	C45/CW	374	C55MP	367	
9526RMN	593	9592M/50	593	C22B	301	C45/CX	374	C55MS	362	
9527 6T	592	9592MB	593	C22P	301	C45/W	372	C55P/2MDX-SX	363	
9527MUG	593	9593A	587	C22P	301	C45/X	372	C55P/MCD	363	
9533N	587	9593M	587	C22S - 2200S	304	C45AS1	380	C55PB/3	351	
9534B	587	9593W	587	C22W	301	C45AS2	380	C55/PF	363	
9534W	587	9594	592	C23S- 2300S	304	C45C7	377	C55PFA-0,8	365	
9537N	587	9595C	593	C23SC	305	C45CORNER/W	379	C55PFA-1,0	363	
9539CB S/M	589	9595 C25	593	C23ST- 2300ST	305	C45CORNER/X	379	C55/PL-1,024	356	
9541BIKE	588	9595T	593	C24 SL-CAB	317	C45LMP	381	C55PM	363	
9541F	588	9596	593	C24S/5 - 2400S5	306	C45M5	377	C55PM/M0,8	365	
9541S	588	9597P	591	C24S/6- 2400S6	307	C45M7	377	C55PRO B/2	352	
9542AL	591	9598W - A	589	C24S/7- 2400S7	308	C45MA	378	C55PRO B/2,8	353	
9542AT	590	9598WHP	589	C24S/8 - 2400S8	309	C45MS	378	C55PS	366	
9542C	590	9599CB	589	C24SA/6- 2400SA6	310	C45PF	379	C55PSE	366	
9542G	590	9599CB-W	589	C24SA/7 - 2400SA7	311	C45PM	380	C55PT0,8x0,6	365	
9542GW	590	9710	468	C24SA/8 - 2400SA8	312	C45PW/2-1,3MT	376	C55PT1,0x0,6	364	
9542M	590	9712	468	C24SA-XL/7 - 2400SAXL7	313	C45PW/3-2,0MT	376	C55PTE-0,8	365	
9542S	590	9720	469	C24SA-XL/8 - 2400SAXL8	314	C45PX/2-1,3MT	376	C55PTE-1,0	364	
9544C	588	9722	469	C24SA-XL/9 - 2400SAXL9	315	C45PX/3-2,0MT	376	C55RB	357	
9547	592	9724	469	C25 - 2500	318	C45SL	378	C55STR	371	
9547T	591	9726	469	C27S	319	C45SS	378	C55T3	362	
9547WSK	591	9729	469	C28 - 2800	320	C51	340	C56	345	
9548G	591	9740	469	C30S - 3000S	321	C54S	341	C56M	345	
9548KB	591	9742	469	C35/6G	322	C55	350	C56P O	341	
9549PB	592	9745	469	C35/7G	322	C55/1PF	365	C56W	345	
9549USB	592	9752	469	C35/8G	323	C55/2PM	364	C57S C	343	
9557J 2.0	588	9801L	467	C35/9G	323	C55A1	369	C57S D	342	
9557J 3.0	588	9802M	466	C37/6	324	C55A1/R42	369	C57SA - 5700SA	342	
9557N	588	9803H	466	C37/7	325	C55A2	370	C57SB - 5700SB	343	
9559	591	9811L	467	C37/8	326	C55A2/R70	370	C57SP - 5700SP	344	
9559/30MT	591	9812M	467	C38 - 3800	328	C55AB	351	C58M	346	
9561V	591	9813H	467	C38C	329	C55AC	367	C58M/PA	346	
9561VV	591	9821L	468	C38L	328	C55AE	366	C58P - 5800P	344	
9562P2	371,594	9822M	467	C38LA	328	C55B/1	368	C59A - 5900A	346	
9562P25	371,594	9823H	467	C38T	329	C55B/2	352	C59B - 5900B	347	
9562T2	347,594	9831L	468			C55B/2,8	353	C59C - 5900C	347	
9562T3	238,594	9832M	468			C55B-D4	354	C62M/W	549	
9562TB	549,594	9833H	468			C55B/G	355	C63 E/W	549	

ALPHANUMERIC INDEX

C63 G/C	549	M121	444	MC20	449	T82	456	T234	461
C68	503	M125	444	MC21	449	T83	456	T236	461
C68 G	503	M128	444	MM10	452	T85	456	T239	461
C88 R/1	503	M130	444	MM61	452	T91	456	T241	462
C88SE	503	M131	444	MM105	452	T92	456	T250	462
C88VE	503	M132	445	MM140	452	T99	457	T256	462
C9/RT	298	M135	445	MM210	452	T100	457	T259	462
CA49-G	339	M145	445			T101	457	T264	462
CB/2	465	M153	445	P, S		T102	457	T270	462
CB52	340	M161	445			T103	457	T273	462
CD23S	304	M165	445	PM/5C	381	T105	457	T281	462
CP15L	300	M170	445	PM/6C	381	T106	457	T284	463
CP17 - CP17L - 2117	300	M172	445	PV	344	T110	457	T285	462
CP51	340	M174	445	S42/17	465	T112	457	T289	463
CX49-G	339	M180	445	S55/8	465	T113	457	T291	463
G,K		M195	446	S55/12	465	T121	457	T297	463
GM	464	M199	446	S951/6	465	T131	457		
KIT/GPS	464	M202	446	S952/10	465	T132	458	V	
M		M204	446	S96T/8	465	T135	458		
M10	440	M208	446	S1719BM	465	T136	458	VE1	464
M13	440	M209	446	SB	464	T140	458	VP1 - VP2	463
M15	440	M210	446	SGN	465	T142	458	VP3 - VP4	463
M16	440	M211	446	SPG11 - S1203/8	465	T145	458	VP-3SC	463
M25	440	M212	446	ST2P	465	T146	458	VP5	463
M30	440	M215	447	T		T151	458	VP6	463
M31	440	M220	447			T153	458	VP-LD	463
M33	440	M221	447	T10	453	T154	458	VP-LS	463
M38	440	M223	447	T13	453	T155	458	VPM0	453
M40	440	M224	447	T15	453	T160	458	VPM3	453
M45	441	M226	447	T16	453	T161	459	VPM7	453
M46	441	M227	447	T18	454	T164	459	VPM7-C	453
M49	441	M230	447	T19	454	T167	459	VPM8	453
M50	441	M231	447	T22	454	T168	459	VPM9	453
M52	441	M234	448	T23	454	T170	459		
M53	441	M236	448	T31	454	T171	459		
M55	441	M237	448	T33	454	T172	459		
M60	441	M240	448	T34	454	T173	459		
M62	441	M264	448	T40	454	T175	459		
M63	441	M284	448	T41	454	T176	459		
M65	442	M285	448	T45	454	T177	459		
M69	442	M289	448	T46	454	T180	460		
M75	442	M295	448	T48	454	T183	460		
M78	442	M305	448	T50	455	T198	460		
M79	442	M310	448	T52	455	T199	460		
M82	442	MB	464	T53	455	T201	460		
M83	442	MB11	449	T55	455	T202	460		
M85	442	MB34	449	T56	455	T204	460		
M86	442	MB35	450	T57	455	T205	460		
M91	443	MB36	450	T59	455	T206	460		
M92	443	MB44	450	T63	455	T207	460		
M94	443	MB45	450	T64	455	T208	460		
M96	443	MB46	450	T65	455	T209	460		
M100	443	MB47	450	T68	455	T210	461		
M105	443	MB56	450	T73	455	T212	461		
M108	444	MB57	451	T75	456	T215	461		
M110	444	MB58	451	T76	456	T220	461		
M112	444	MB61	451	T77	456	T226	461		
M120	444	MB63	451	T79	456	T227	461		
		MB64	451	T80	456	T228	461		
		MC10	449	T81	456	T231	461		
		MC11	449			T233	461		

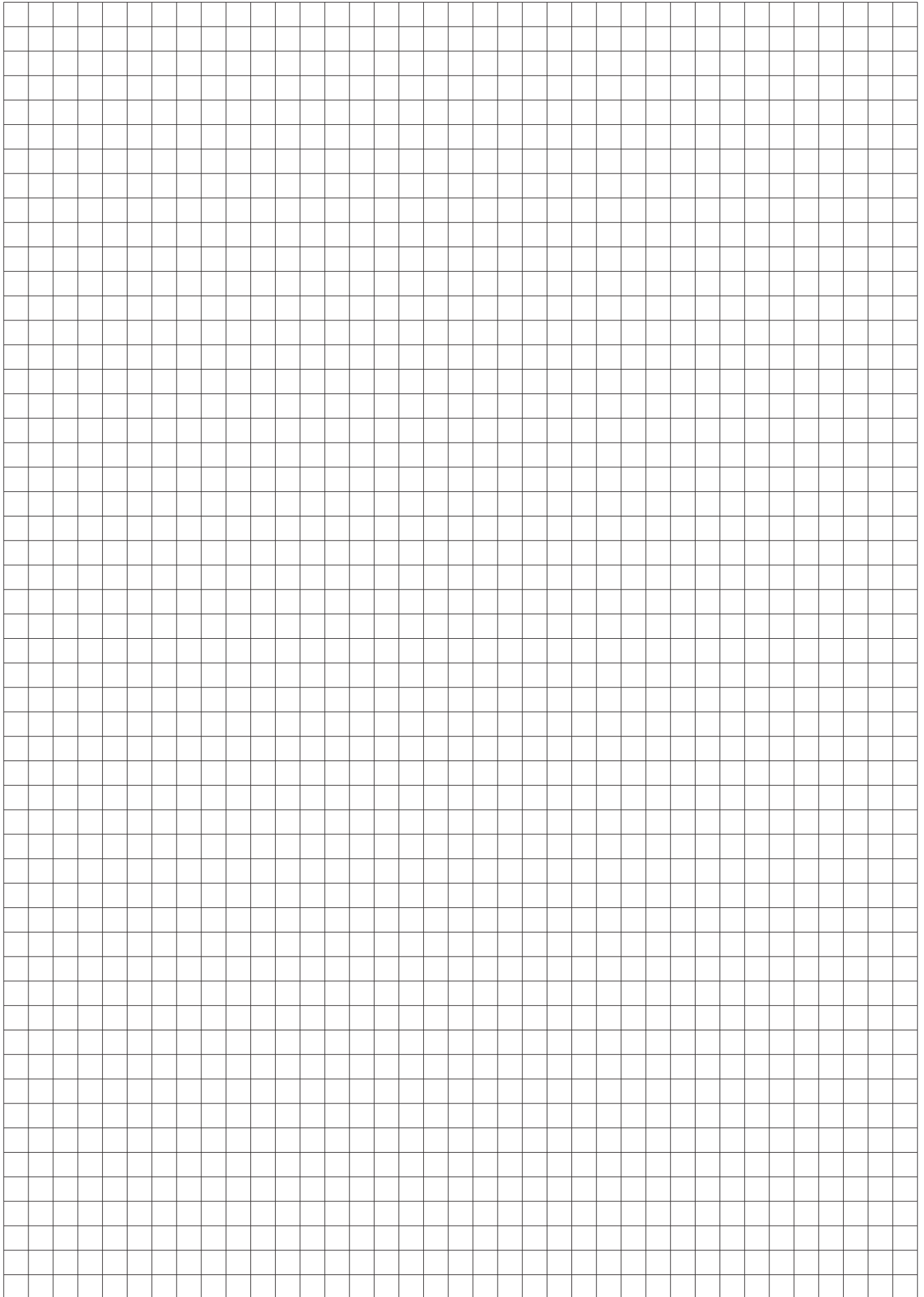

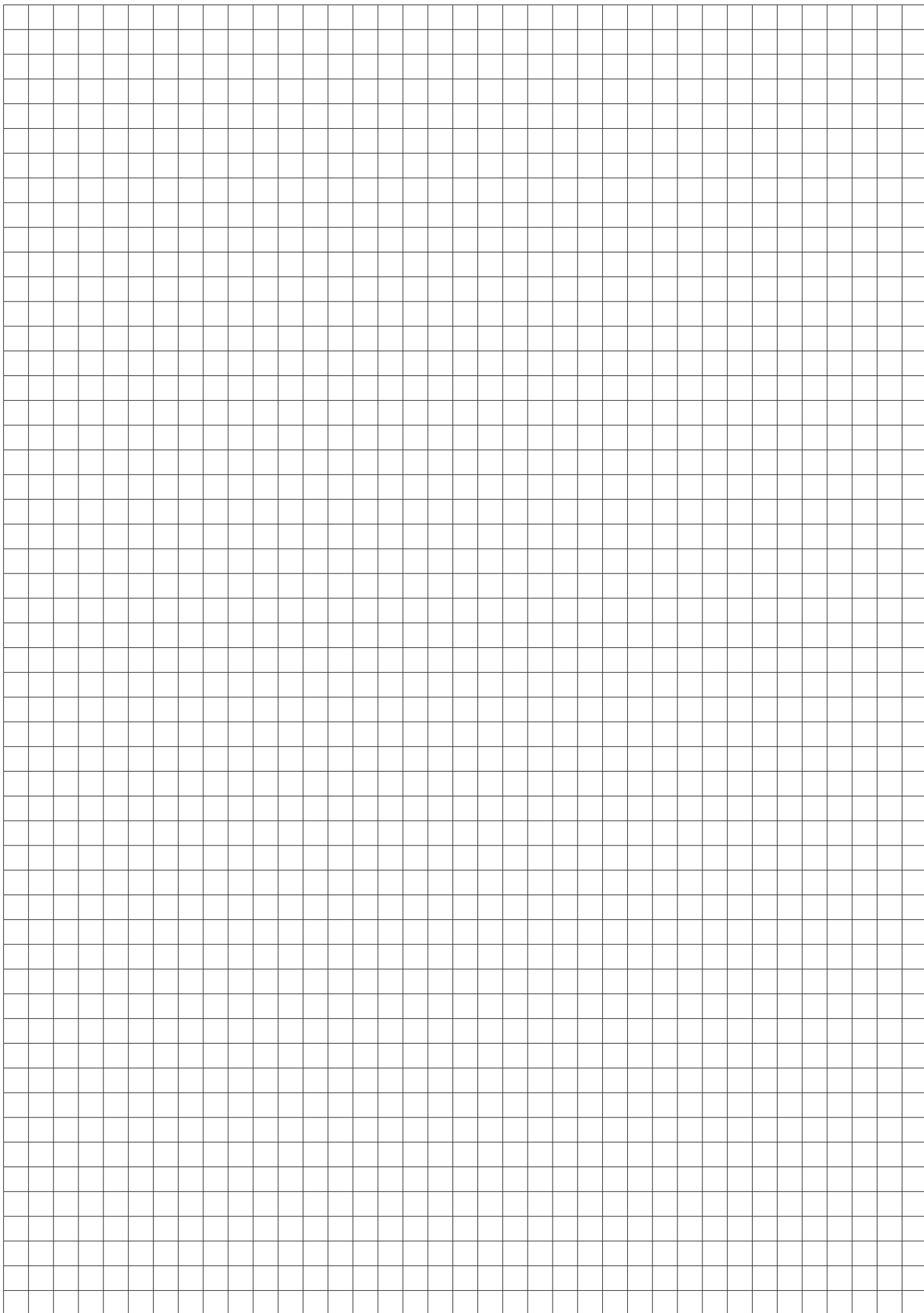

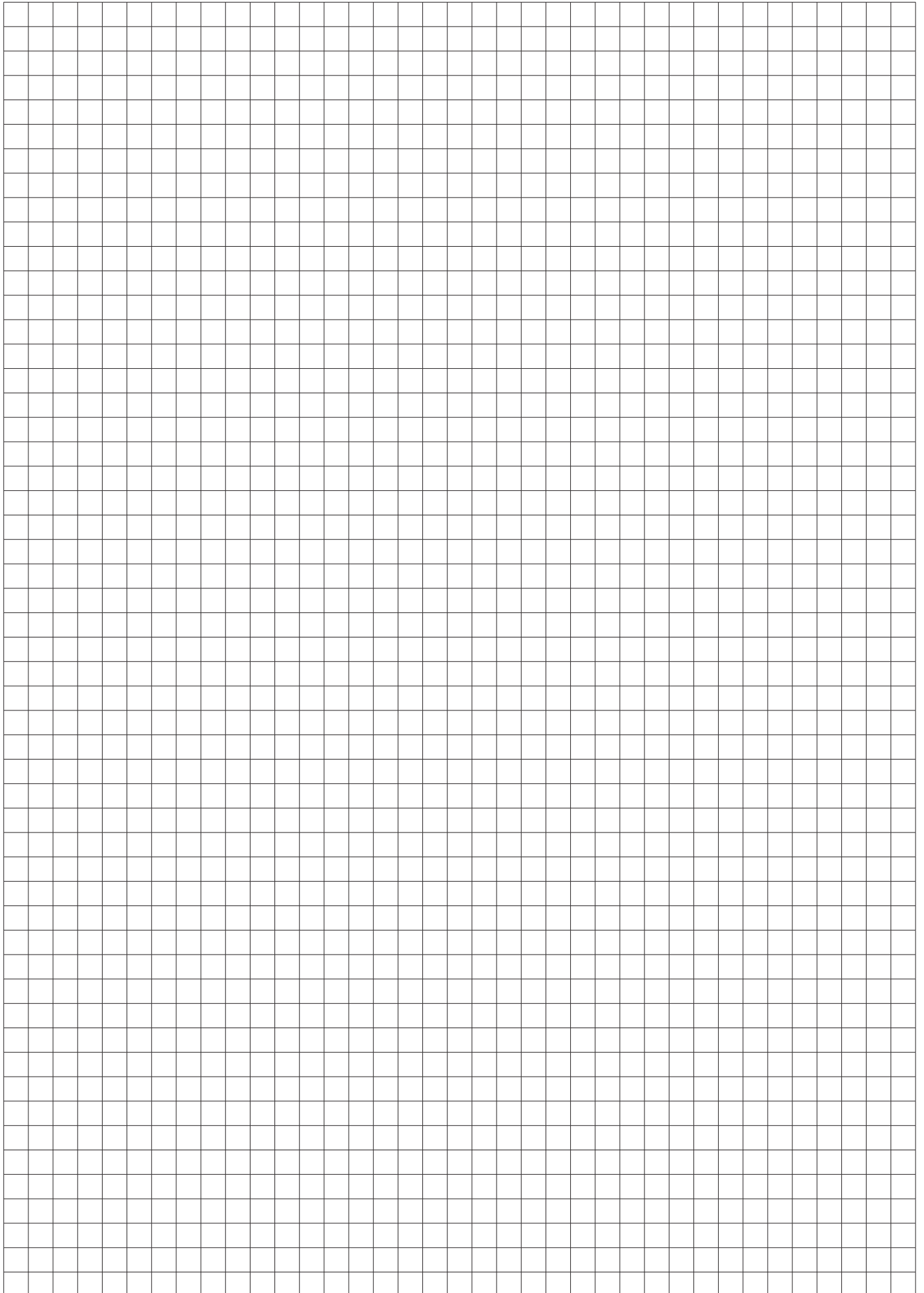

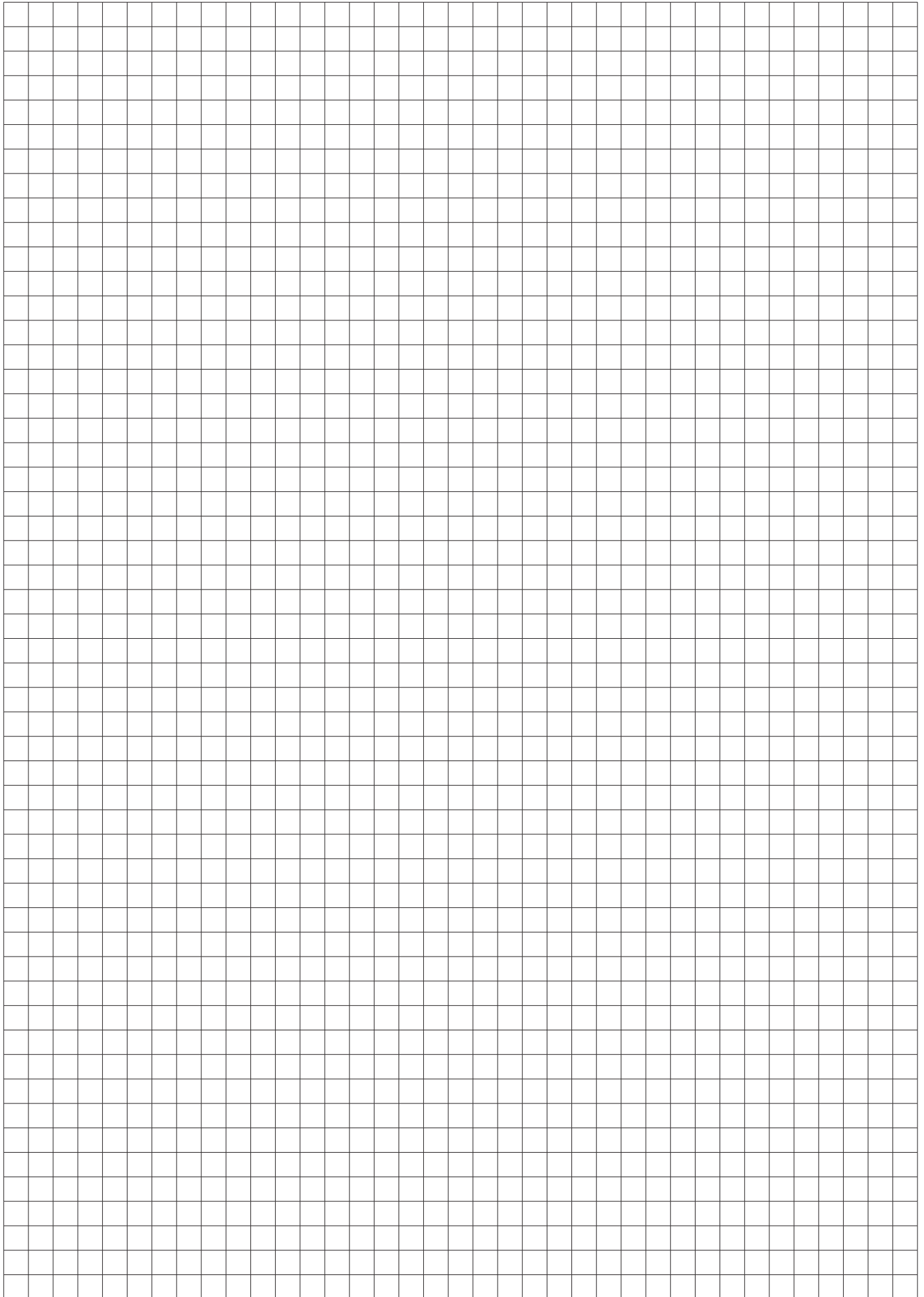

Beta

REC 55



50
years in
motorsports

 **Beta**

PARTNERSHIP

 **Robur**

 **Beta
WORK**

 **Beta
SHOP
in shop**

 **Beta
Collection**

 **3D Beta**
Made in Italy

 **BM**
GROUP

 **bro
Beta**

 **VDF**
VERNICIATURA



 **speedUP**
Racing Spirit

Jorge Navarro
Moto2 World Championship

998068841

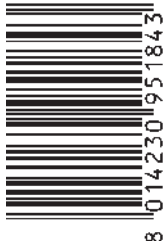

Technical
Partner

